

Document Title	Specification of GPT Driver
Document Owner	AUTOSAR
Document Responsibility	AUTOSAR
Document Identification No	030
Document Classification	Standard

Document Status	Final
Part of AUTOSAR Release	4.2.2

Document Change History		
Release	Changed by	Change Description
4.2.2	AUTOSAR Release Management	<ul style="list-style-type: none"> • Det renaming and extension incorporation • Debugging support marked as obsolete • Remove duplicated requirements in traceability
4.2.1	AUTOSAR Release Management	<ul style="list-style-type: none"> • Init pointer check harmonized with BSW_General, redundant SWS_GPT_00294, SWS_GPT_00340 items removed • Added new error code GPT_E_INIT_FAILED
4.1.2	AUTOSAR Release Management	<ul style="list-style-type: none"> • Editorial changes
4.1.1	AUTOSAR Administration	<ul style="list-style-type: none"> • GPT Predef Timer functionality added • Gpt_GetTimeElapsed and Gpt_GetTimeRemaining are fully reentrant now • MemMap.h renamed to Gpt_MemMap.h
4.0.3	AUTOSAR Administration	<ul style="list-style-type: none"> • Range added to ECUC_Gpt_00331 • "module short name" replaced by "module abbreviation" • Chapter 6 revised and chapter 13 added due to new traceability mechanism
4.0.2	AUTOSAR Administration	<ul style="list-style-type: none"> • GPT208, GPT376 and GPT378 removed • Multiplicity changed in ECUC_Gpt_00312 (chapter 10.2.6 updated) • SWS_Gpt_00256 rephrased • SWS_Gpt_00256 changed according to changed SRS_BSW_00004

Document Change History		
Release	Changed by	Change Description
4.0.1	AUTOSAR Administration	<ul style="list-style-type: none"> • Revised completely, a lot of SWS items deleted, replaced, changed and added • Gpt_Cbk_CheckWakeup renamed to Gpt_CheckWakeup • Parameter names of API services renamed • Configuration parameters renamed, deleted and added • Debugging Concept incorporated • ClockReferencePoint mechanism incorporated • Traceability tables updated • Legal disclaimer revised • Chapter 10.3 revised
3.1.1	AUTOSAR Administration	<ul style="list-style-type: none"> • Legal disclaimer revised
3.0.1	AUTOSAR Administration	<ul style="list-style-type: none"> • Introduction of consistent description of wakeup concept (as evaluated in Startup/ Wakeup Taskforce). This includes modifications and extensions of textual descriptions as well as the modification of sequence charts related to wakeup. • SWS Improvement: improvement of wording, alignment of API description • Introduction of additional development error in case of already initialized module • Document meta information extended • Small layout adaptations made
2.1.15	AUTOSAR Administration	<ul style="list-style-type: none"> • Header file structure changed significantly • Return values and development errors for Gpt_GetTimeRemaining() and Gpt_GetTimeElapsed() changed • Development error checking of ConfigPtr in Gpt_Init() changed • Configuration container structure and configuration parameters • changed • Interface Dem_ReportErrorEvent() removed • Legal disclaimer revised • Release Notes added • “Advice for users” revised • “Revision Information” added
2.0	AUTOSAR Administration	<ul style="list-style-type: none"> • Document structure adapted to common Release 2.0 SWS Template. • Added wake-up functionality • For more details see chapter 11

Document Change History		
Release	Changed by	Change Description
1.0	AUTOSAR Administration	<ul style="list-style-type: none">• Initial release

Disclaimer

This specification and the material contained in it, as released by AUTOSAR, is for the purpose of information only. AUTOSAR and the companies that have contributed to it shall not be liable for any use of the specification.

The material contained in this specification is protected by copyright and other types of Intellectual Property Rights. The commercial exploitation of the material contained in this specification requires a license to such Intellectual Property Rights.

This specification may be utilized or reproduced without any modification, in any form or by any means, for informational purposes only. For any other purpose, no part of the specification may be utilized or reproduced, in any form or by any means, without permission in writing from the publisher.

The AUTOSAR specifications have been developed for automotive applications only. They have neither been developed, nor tested for non-automotive applications.

The word AUTOSAR and the AUTOSAR logo are registered trademarks.

Advice for users

AUTOSAR specifications may contain exemplary items (exemplary reference models, "use cases", and/or references to exemplary technical solutions, devices, processes or software).

Any such exemplary items are contained in the specifications for illustration purposes only, and they themselves are not part of the AUTOSAR Standard. Neither their presence in such specifications, nor any later documentation of AUTOSAR conformance of products actually implementing such exemplary items, imply that intellectual property rights covering such exemplary items are licensed under the same rules as applicable to the AUTOSAR Standard.

Table of Contents

1	Introduction and functional overview	7
2	Acronyms, abbreviations and terms	8
3	Related documentation.....	9
3.1	Input documents.....	9
3.2	Related standards and norms	10
3.3	Related specification	10
4	Constraints and assumptions	11
4.1	Assumptions.....	11
4.2	Limitations	11
4.3	Applicability to car domains	11
5	Dependencies to other modules.....	12
6	Requirements traceability	14
7	Functional specification	24
7.1	General behavior	24
7.2	GPT Predef Timers.....	27
7.3	Version checking	28
7.4	Error classification	29
7.5	Error detection.....	30
7.6	Debugging	30
8	API specification.....	31
8.1	Imported types.....	31
8.2	Type Definitions.....	31
8.3	Error notification	31
8.3.1	Gpt_ConfigType.....	31
8.3.2	Gpt_ChannelType.....	31
8.3.3	Gpt_ValueType.....	32
8.3.4	Gpt_ModeType	32
8.3.5	Gpt_PredefTimerType	32
8.4	Function definitions.....	32
8.4.1	Gpt_GetVersionInfo	32
8.4.2	Gpt_Init	33
8.4.3	Gpt_DeInit	34
8.4.4	Gpt_GetTimeElapsed	35
8.4.5	Gpt_GetTimeRemaining	37
8.4.6	Gpt_StartTimer	38
8.4.7	Gpt_StopTimer	39
8.4.8	Gpt_EnableNotification	40
8.4.9	Gpt_DisableNotification	41
8.4.10	Gpt_SetMode.....	42
8.4.11	Gpt_DisableWakeup.....	43
8.4.12	Gpt_EnableWakeup.....	44
8.4.13	Gpt_CheckWakeup.....	45

8.4.14	Gpt_GetPredefTimerValue	46
8.5	Call-back Notifications	47
8.6	Scheduled functions	48
8.7	Expected Interfaces	48
8.7.1	Mandatory Interfaces	48
8.7.2	Optional Interfaces	48
8.7.3	Configurable Interfaces	48
8.7.3.1	GPT Notification	49
9	Sequence diagrams	50
9.1	Gpt_Init	50
9.2	GPT continuous mode	51
9.3	GPT one-shot mode	52
9.4	Disable/Enable Notifications	53
9.5	Wakeup	54
10	Configuration specification	55
10.1	How to read this chapter	55
10.2	Containers and configuration parameters	56
10.2.1	Variants	56
10.2.2	Gpt	57
10.2.3	GptDriverConfiguration	57
10.2.4	GptClockReferencePoint	59
10.2.5	GptChannelConfigSet	60
10.2.6	GptChannelConfiguration	60
10.2.7	GptWakeupConfiguration	62
10.2.8	GptConfigurationOfOptApiServices	63
10.3	Published Information	64
11	Not applicable requirements	65

1 Introduction and functional overview

This specification specifies the functionality, API and the configuration of the AUTOSAR Basic Software module GPT driver.

The GPT driver is part of the microcontroller abstraction layer (MCAL). It initializes and controls the internal General Purpose Timer(s) (GPT) of the microcontroller.

The GPT driver provides services and configuration parameters for

- Starting and stopping hardware timers
- Getting timer values
- Controlling time triggered interrupt notifications, if supported by hardware
- Controlling time triggered wakeup interrupts, if supported by hardware

The tick duration of a timer channel depends on channel specific settings (part of GPT driver) as well as on system clock and settings of the clock tree controlled by the MCU module. The tick duration is not limited by this specification.

Not all hardware timers must be controlled by the GPT module. Some timers may be controlled by AUTOSAR Operating System or Complex Drivers directly. The number of timer channels controlled by the GPT driver depends on hardware, implementation and system configuration.

Beside the possibility to configure individual timer channels with individual properties, some free running up counters – so-called GPT Predef Timers – are defined. These timers have predefined tick durations and predefined number of bits (physical time units and ranges). The GPT Predef Timers are used by the Time Service module.

The GPT driver only generates time bases. Further time based functionality on driver level is covered by other MCAL modules like:

- PWM Driver (driver for pulse width modulation)
- ICU Driver (driver for input capture unit)
- OCU Driver (driver for output compare unit)

2 Acronyms, abbreviations and terms

Only a few acronyms and abbreviations are listed here which are helpful to understand this document or which have a local scope. Further information can be found in the official AUTOSAR glossary [13].

Acronym / Abbreviation	Description
BSW	Basic Software
DEM	Diagnostic Event Manager
DET	Default Error Tracer
ECU	Electronic Control Unit
GPT	General Purpose Timer
ICU	Input Capture Unit
MCU	Micro Controller Unit
NOP, nop	Null Operation
OS	Operating System

Table 1: Acronyms and abbreviations

The terms defined in the table below have a local scope within this document.

Term	Description
Timer channel	Represents a logical timer entity assigned to a timer hardware
Target time	Time, something shall occur, when the value is reached. The behavior depends on the configuration and the enabled functionality.
Tick	Defines the timer resolution, the duration of a timer increment
GPT Predef Timer	A GPT Predef Timer is a free running up counter provided by the GPT driver. Which GPT Predef Timer(s) are available depends on hardware (clock, hardware timers, prescaler, width of timer register, ...) and configuration. A GPT Predef Timer has predefined physical time unit and range.

Table 2: Terms

3 Related documentation

3.1 Input documents

- [1] List of Basic Software Modules,
AUTOSAR_TR_BSWModuleList.pdf
- [2] Layered Software Architecture,
AUTOSAR_EXP_LayeredSoftwareArchitecture.pdf
- [3] General Requirements on Basic Software Modules,
AUTOSAR_SRS_BSWGeneral.pdf
- [4] Specification of Standard Types,
AUTOSAR_SWS_StandardTypes.pdf
- [5] Specification of Default Error Tracer,
AUTOSAR_SWS_DefaultErrorTracer.pdf
- [6] Specification of ECU Configuration,
AUTOSAR_TPS_ECUConfiguration.pdf
- [7] Specification of Diagnostic Event Manager,
AUTOSAR_SWS_DiagnosticEventManager.pdf
- [8] Specification of ECU State Manager,
AUTOSAR_SWS_ECUCStateManager.pdf
- [9] General Requirements on SPAL,
AUTOSAR_SRS_SPALGeneral.pdf
- [10] Requirements on GPT Driver,
AUTOSAR_SRS_GPTDriver.pdf
- [11] Specification of ICU Driver,
AUTOSAR_SWS_ICUDriver.pdf
- [12] Specification of MCU Driver,
AUTOSAR_SWS_MCUDriver.pdf
- [13] Glossary,
AUTOSAR_TR_Glossary.pdf
- [14] Basic Software Module Description Template,
AUTOSAR_TPS_BSWModuleDescriptionTemplate.pdf

[15] General Specification of Basic Software Modules,
AUTOSAR_SWS_BSWGeneral.pdf

3.2 Related standards and norms

[16] IEC 7498-1 The Basic Model, IEC Norm, 1994

3.3 Related specification

AUTOSAR provides a General Specification on Basic Software modules [15] (SWS BSW General), which is also valid for GPT Driver.

Thus, the specification SWS BSW General shall be considered as additional and required specification for GPT Driver.

4 Constraints and assumptions

4.1 Assumptions

No assumptions.

4.2 Limitations

No limitations.

4.3 Applicability to car domains

No restrictions.

5 Dependencies to other modules

Module DET [5]

In development mode the Error hook-function of module DET [5] will be called.

Module DEM [7]

Production errors will be reported to the Diagnostic Event Manager

Module MCU [12]

The GPT depends on the system clock, prescaler(s) and PLL. Thus, changes of the system clock (e.g. PLL on → PLL off) also affect the clock settings of the GPT hardware. Module GPT will not take care of settings which configure the clock, prescaler(s) and PLL in its init function. This has to be done by the MCU module [12]. Hence the conversions between time and ticks shall be part of an upper layer.

Module EcuM [8]

The GPT driver reports the wakeup interrupts to the ECU State Manager for further processing.

File structure

The file structure is not defined within this specification completely. It depends on the implementation. The GPT driver shall provide at least the following files, if the conditions described are fulfilled:

[SWS_Gpt_00293] | `Gpt.c` shall include `Gpt.h`.

Comment: `Gpt.c` has implicit access to the `Gpt_Cfg.h` through the `Gpt.h` file.

| ()

[SWS_Gpt_00261] | `Gpt_Irq.c` shall include `Gpt.h` for the prototype declaration of the notification functions. | (SRS_BSW_00164)

[SWS_Gpt_00375] | If Default Error Tracer for the GPT module is enabled:

`Gpt.c` shall include `Det.h` | ()

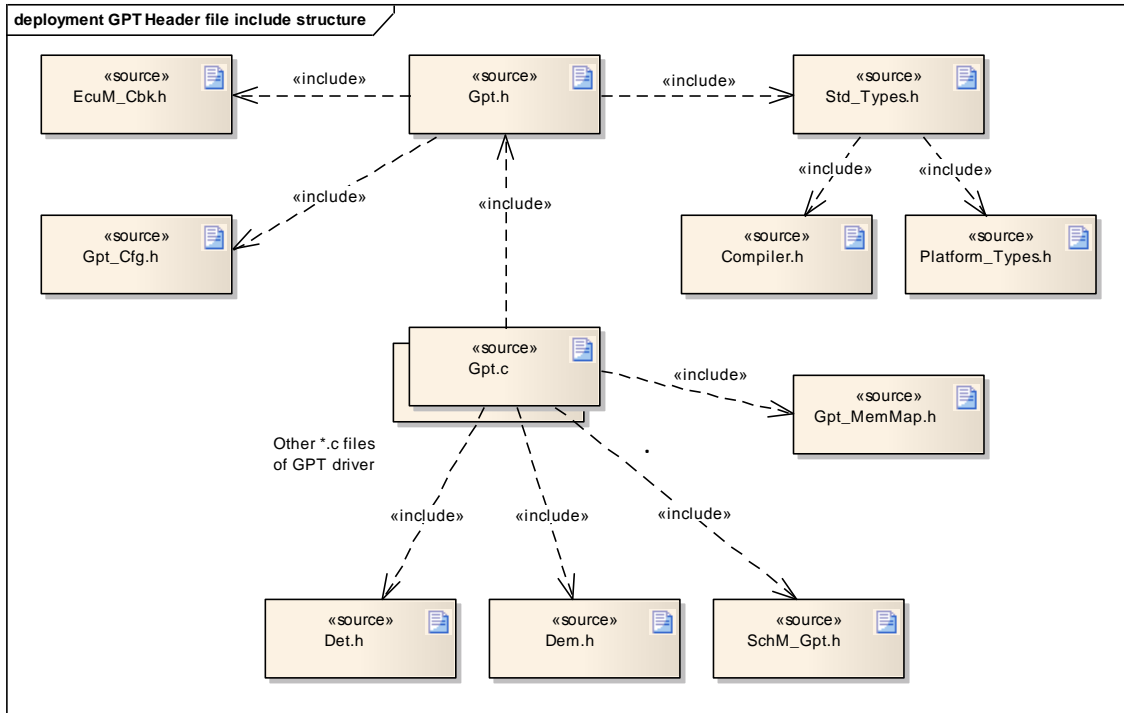

Figure 1: Header file include structure

6 Requirements traceability

This chapter refers to input requirements specified in the SRS documents (Software Requirements Specifications) that are applicable for this software module.

The table below lists links to specification items of the GPT driver SWS document, which satisfy the input requirements. Only functional requirements are referenced.

Requirement	Description	Satisfied by
-	-	SWS_Gpt_00084
-	-	SWS_Gpt_00086
-	-	SWS_Gpt_00093
-	-	SWS_Gpt_00099
-	-	SWS_Gpt_00105
-	-	SWS_Gpt_00107
-	-	SWS_Gpt_00113
-	-	SWS_Gpt_00114
-	-	SWS_Gpt_00115
-	-	SWS_Gpt_00116
-	-	SWS_Gpt_00117
-	-	SWS_Gpt_00118
-	-	SWS_Gpt_00155
-	-	SWS_Gpt_00156
-	-	SWS_Gpt_00157
-	-	SWS_Gpt_00158
-	-	SWS_Gpt_00164
-	-	SWS_Gpt_00165
-	-	SWS_Gpt_00185
-	-	SWS_Gpt_00186
-	-	SWS_Gpt_00210
-	-	SWS_Gpt_00211
-	-	SWS_Gpt_00212
-	-	SWS_Gpt_00213
-	-	SWS_Gpt_00214
-	-	SWS_Gpt_00215
-	-	SWS_Gpt_00216
-	-	SWS_Gpt_00217
-	-	SWS_Gpt_00231
-	-	SWS_Gpt_00234

-	-	SWS_Gpt_00255
-	-	SWS_Gpt_00258
-	-	SWS_Gpt_00270
-	-	SWS_Gpt_00293
-	-	SWS_Gpt_00295
-	-	SWS_Gpt_00297
-	-	SWS_Gpt_00299
-	-	SWS_Gpt_00301
-	-	SWS_Gpt_00303
-	-	SWS_Gpt_00305
-	-	SWS_Gpt_00307
-	-	SWS_Gpt_00309
-	-	SWS_Gpt_00321
-	-	SWS_Gpt_00322
-	-	SWS_Gpt_00323
-	-	SWS_Gpt_00324
-	-	SWS_Gpt_00326
-	-	SWS_Gpt_00328
-	-	SWS_Gpt_00329
-	-	SWS_Gpt_00330
-	-	SWS_Gpt_00331
-	-	SWS_Gpt_00337
-	-	SWS_Gpt_00339
-	-	SWS_Gpt_00341
-	-	SWS_Gpt_00343
-	-	SWS_Gpt_00344
-	-	SWS_Gpt_00361
-	-	SWS_Gpt_00362
-	-	SWS_Gpt_00363
-	-	SWS_Gpt_00364
-	-	SWS_Gpt_00375
-	-	SWS_Gpt_00377
-	-	SWS_Gpt_00379
-	-	SWS_Gpt_00380
-	-	SWS_Gpt_00384
-	-	SWS_Gpt_00386
-	-	SWS_Gpt_00396
-	-	SWS_Gpt_00400
-	-	SWS_Gpt_00401

SRS_BSW_00005	Modules of the $\hat{\mu}$ C Abstraction Layer (MCAL) may not have hard coded horizontal interfaces	SWS_Gpt_00381
SRS_BSW_00006	The source code of software modules above the $\hat{\mu}$ C Abstraction Layer (MCAL) shall not be processor and compiler dependent.	SWS_Gpt_00381
SRS_BSW_00007	All Basic SW Modules written in C language shall conform to the MISRA C 2004 Standard.	SWS_Gpt_00381
SRS_BSW_00009	All Basic SW Modules shall be documented according to a common standard.	SWS_Gpt_00381
SRS_BSW_00010	The memory consumption of all Basic SW Modules shall be documented for a defined configuration for all supported platforms.	SWS_Gpt_00381
SRS_BSW_00101	The Basic Software Module shall be able to initialize variables and hardware in a separate initialization function	SWS_Gpt_00006, SWS_Gpt_00280
SRS_BSW_00159	All modules of the AUTOSAR Basic Software shall support a tool based configuration	SWS_Gpt_00381
SRS_BSW_00160	Configuration files of AUTOSAR Basic SW module shall be readable for human beings	SWS_Gpt_00381
SRS_BSW_00161	The AUTOSAR Basic Software shall provide a microcontroller abstraction layer which provides a standardized interface to higher software layers	SWS_Gpt_00381
SRS_BSW_00162	The AUTOSAR Basic Software shall provide a hardware abstraction layer	SWS_Gpt_00381
SRS_BSW_00164	The Implementation of interrupt service routines shall be done by the Operating System, complex drivers or modules	SWS_Gpt_00261
SRS_BSW_00167	All AUTOSAR Basic Software Modules shall provide configuration rules and constraints to enable plausibility checks	SWS_Gpt_00381
SRS_BSW_00168	SW components shall be tested by a function defined in a common API in the Basis-SW	SWS_Gpt_00381
SRS_BSW_00170	The AUTOSAR SW Components shall provide information about their dependency from faults, signal qualities, driver demands	SWS_Gpt_00381

SRS_BSW_00171	Optional functionality of a Basic-SW component that is not required in the ECU shall be configurable at pre-compile-time	SWS_Gpt_00194, SWS_Gpt_00196, SWS_Gpt_00200, SWS_Gpt_00202, SWS_Gpt_00203	SWS_Gpt_00195, SWS_Gpt_00199, SWS_Gpt_00201, SWS_Gpt_00203
SRS_BSW_00172	The scheduling strategy that is built inside the Basic Software Modules shall be compatible with the strategy used in the system	SWS_Gpt_00381	
SRS_BSW_00305	Data types naming convention	SWS_Gpt_00357, SWS_Gpt_00359, SWS_Gpt_00360	SWS_Gpt_00358, SWS_Gpt_00360
SRS_BSW_00306	AUTOSAR Basic Software Modules shall be compiler and platform independent	SWS_Gpt_00381	
SRS_BSW_00307	Global variables naming convention	SWS_Gpt_00381	
SRS_BSW_00308	AUTOSAR Basic Software Modules shall not define global data in their header files, but in the C file	SWS_Gpt_00381	
SRS_BSW_00309	All AUTOSAR Basic Software Modules shall indicate all global data with read-only purposes by explicitly assigning the const keyword	SWS_Gpt_00381	
SRS_BSW_00321	The version numbers of AUTOSAR Basic Software Modules shall be enumerated according specific rules	SWS_Gpt_00381	
SRS_BSW_00323	All AUTOSAR Basic Software Modules shall check passed API parameters for validity	SWS_Gpt_00218, SWS_Gpt_00399, SWS_Gpt_00403	SWS_Gpt_00338, SWS_Gpt_00403
SRS_BSW_00325	The runtime of interrupt service routines and functions that are running in interrupt context shall be kept short	SWS_Gpt_00381	
SRS_BSW_00328	All AUTOSAR Basic Software Modules shall avoid the duplication of code	SWS_Gpt_00381	
SRS_BSW_00330	It shall be allowed to use macros instead of functions where source code is used and runtime is critical	SWS_Gpt_00381	
SRS_BSW_00331	All Basic Software Modules shall strictly separate error and status information	SWS_Gpt_00381	
SRS_BSW_00333	For each callback function it shall be specified if it is called from interrupt context or not	SWS_Gpt_00381	
SRS_BSW_00334	All Basic Software Modules shall provide an XML file that contains the meta data	SWS_Gpt_00381	
SRS_BSW_00335	Status values naming convention	SWS_Gpt_00381	

SRS_BSW_00336	Basic SW module shall be able to shutdown	SWS_Gpt_00008, SWS_Gpt_00281
SRS_BSW_00341	Module documentation shall contains all needed informations	SWS_Gpt_00381
SRS_BSW_00342	It shall be possible to create an AUTOSAR ECU out of modules provided as source code and modules provided as object code, even mixed	SWS_Gpt_00381
SRS_BSW_00344	BSW Modules shall support link-time configuration	SWS_Gpt_00381
SRS_BSW_00347	A Naming separation of different instances of BSW drivers shall be in place	SWS_Gpt_00381
SRS_BSW_00348	All AUTOSAR standard types and constants shall be placed and organized in a standard type header file	SWS_Gpt_00278, SWS_Gpt_00381
SRS_BSW_00353	All integer type definitions of target and compiler specific scope shall be placed and organized in a single type header	SWS_Gpt_00381
SRS_BSW_00357	For success/failure of an API call a standard return type shall be defined	SWS_Gpt_00381
SRS_BSW_00358	The return type of init() functions implemented by AUTOSAR Basic Software Modules shall be void	SWS_Gpt_00280
SRS_BSW_00359	All AUTOSAR Basic Software Modules callback functions shall avoid return types other than void if possible	SWS_Gpt_00381
SRS_BSW_00360	AUTOSAR Basic Software Modules callback functions are allowed to have parameters	SWS_Gpt_00381
SRS_BSW_00361	All mappings of not standardized keywords of compiler specific scope shall be placed and organized in a compiler specific type and keyword header	SWS_Gpt_00381
SRS_BSW_00369	All AUTOSAR Basic Software Modules shall not return specific development error codes via the API	SWS_Gpt_00403
SRS_BSW_00373	The main processing function of each AUTOSAR Basic Software Module shall be named according the defined convention	SWS_Gpt_00381
SRS_BSW_00375	Basic Software Modules shall report wake-up reasons	SWS_Gpt_00209, SWS_Gpt_00292

SRS_BSW_00377	A Basic Software Module can return a module specific types	SWS_Gpt_00381
SRS_BSW_00378	AUTOSAR shall provide a boolean type	SWS_Gpt_00381
SRS_BSW_00397	The configuration parameters in pre-compile time are fixed before compilation starts	SWS_Gpt_00342
SRS_BSW_00398	The link-time configuration is achieved on object code basis in the stage after compiling and before linking	SWS_Gpt_00381
SRS_BSW_00399	Parameter-sets shall be located in a separate segment and shall be loaded after the code	SWS_Gpt_00342
SRS_BSW_00400	Parameter shall be selected from multiple sets of parameters after code has been loaded and started	SWS_Gpt_00342
SRS_BSW_00404	BSW Modules shall support post-build configuration	SWS_Gpt_00280, SWS_Gpt_00357
SRS_BSW_00405	BSW Modules shall support multiple configuration sets	SWS_Gpt_00280, SWS_Gpt_00357
SRS_BSW_00406	A static status variable denoting if a BSW module is initialized shall be initialized with value 0 before any APIs of the BSW module is called	SWS_Gpt_00220, SWS_Gpt_00222, SWS_Gpt_00223, SWS_Gpt_00224, SWS_Gpt_00225, SWS_Gpt_00226, SWS_Gpt_00227, SWS_Gpt_00228, SWS_Gpt_00229, SWS_Gpt_00230, SWS_Gpt_00325, SWS_Gpt_00398, SWS_Gpt_00402
SRS_BSW_00407	Each BSW module shall provide a function to read out the version information of a dedicated module implementation	SWS_Gpt_00279
SRS_BSW_00413	An index-based accessing of the instances of BSW modules shall be done	SWS_Gpt_00381
SRS_BSW_00414	Init functions shall have a pointer to a configuration structure as single parameter	SWS_Gpt_00257, SWS_Gpt_00357, SWS_Gpt_00280,
SRS_BSW_00415	Interfaces which are provided exclusively for one module shall be separated into a dedicated header file	SWS_Gpt_00381
SRS_BSW_00416	The sequence of modules to be initialized shall be configurable	SWS_Gpt_00381
SRS_BSW_00417	Software which is not part of the SW-C shall report error events only after the DEM is fully operational.	SWS_Gpt_00381
SRS_BSW_00422	Pre-de-bouncing of error status information is done within the DEM	SWS_Gpt_00381

SRS_BSW_00423	BSW modules with AUTOSAR interfaces shall be describable with the means of the SW-C Template	SWS_Gpt_00381
SRS_BSW_00424	BSW module main processing functions shall not be allowed to enter a wait state	SWS_Gpt_00381
SRS_BSW_00425	The BSW module description template shall provide means to model the defined trigger conditions of schedulable objects	SWS_Gpt_00381
SRS_BSW_00426	BSW Modules shall ensure data consistency of data which is shared between BSW modules	SWS_Gpt_00381
SRS_BSW_00427	ISR functions shall be defined and documented in the BSW module description template	SWS_Gpt_00381
SRS_BSW_00428	A BSW module shall state if its main processing function(s) has to be executed in a specific order or sequence	SWS_Gpt_00381
SRS_BSW_00429	BSW modules shall be only allowed to use OS objects and/or related OS services	SWS_Gpt_00381
SRS_BSW_00432	Modules should have separate main processing functions for read/receive and write/transmit data path	SWS_Gpt_00381
SRS_BSW_00433	Main processing functions are only allowed to be called from task bodies provided by the BSW Scheduler	SWS_Gpt_00381
SRS_BSW_00437	Memory mapping shall provide the possibility to define RAM segments which are not to be initialized during startup	SWS_Gpt_00381
SRS_BSW_00438	Configuration data shall be defined in a structure	SWS_Gpt_00280, SWS_Gpt_00357
SRS_BSW_00439	Enable BSW modules to handle interrupts	SWS_Gpt_00381
SRS_BSW_00440	The callback function invocation by the BSW module shall follow the signature provided by RTE to invoke servers via Rte_Call API	SWS_Gpt_00381
SRS_BSW_00441	Naming convention for type, macro and function	SWS_Gpt_00360
SRS_Gpt_12116	The GPT Driver shall provide the functionality to deinitialize timer channels to their power on reset state	SWS_Gpt_00008, SWS_Gpt_00162, SWS_Gpt_00281, SWS_Gpt_00308
SRS_Gpt_12117	The GPT Driver shall provide a synchronous service for reading	SWS_Gpt_00010, SWS_Gpt_00083, SWS_Gpt_00282, SWS_Gpt_00283

	the current timer value of each timer channel	
SRS_Gpt_12119	The GPT driver shall provide the service for stopping each channel of the timer	SWS_Gpt_00013, SWS_Gpt_00285
SRS_Gpt_12120	The GPT Driver shall provide a notification per channel that is called when the time period has elapsed	SWS_Gpt_00233
SRS_Gpt_12121	The GPT Driver shall provide the functionality to enable the call of a notification function per channel during the runtime	SWS_Gpt_00014, SWS_Gpt_00286
SRS_Gpt_12122	The GPT Driver shall provide the functionality to disable the call of a notification function per channel during the runtime	SWS_Gpt_00015, SWS_Gpt_00287
SRS_Gpt_12128	The GPT driver shall provide a service for starting a timer with specific parameters	SWS_Gpt_00274, SWS_Gpt_00284, SWS_Gpt_00275,
SRS_Gpt_12328	The GPT driver shall use the time unit ticks for all API services which are related to GPT timer channels	SWS_Gpt_00359
SRS_Gpt_13601	-	SWS_Gpt_00127
SRS_Gpt_13602	The GPT driver shall provide a service for enabling / disabling the wake-up capability of single timer channels	SWS_Gpt_00159, SWS_Gpt_00160, SWS_Gpt_00289, SWS_Gpt_00290
SRS_Gpt_13603	The GPT driver shall provide a service for selecting the Wake-up mode	SWS_Gpt_00151, SWS_Gpt_00152, SWS_Gpt_00153, SWS_Gpt_00288
SRS_Gpt_13604	The GPT driver shall support special free running up counters, so-called GPT Predef Timers	SWS_Gpt_00382
SRS_Gpt_13605	Different types of GPT Predef Timers shall be supported by the GPT driver	SWS_Gpt_00383, SWS_Gpt_00389
SRS_Gpt_13606	The GPT driver shall make it possible to configure statically which GPT Predef Timers are enabled	SWS_Gpt_00385
SRS_Gpt_13607	The GPT Predef Timers shall be started/stopped automatically by the GPT driver	SWS_Gpt_00390, SWS_Gpt_00391, SWS_Gpt_00392, SWS_Gpt_00393
SRS_Gpt_13608	The GPT driver shall provide a synchronous service for reading the current timer value of each GPT Predef Timer	SWS_Gpt_00394, SWS_Gpt_00395, SWS_Gpt_00397
SRS_SPAL_00157	All drivers and handlers of the AUTOSAR Basic Software shall implement notification	SWS_Gpt_00014, SWS_Gpt_00015

	mechanisms of drivers and handlers	
SRS_SPAL_12057	All driver modules shall implement an interface for initialization	SWS_Gpt_00006, SWS_Gpt_00280
SRS_SPAL_12063	All driver modules shall only support raw value mode	SWS_Gpt_00359
SRS_SPAL_12064	All driver modules shall raise an error if the change of the operation mode leads to degradation of running operations	SWS_Gpt_00381
SRS_SPAL_12067	All driver modules shall set their wake-up conditions depending on the selected operation mode	SWS_Gpt_00014, SWS_Gpt_00015, SWS_Gpt_00233
SRS_SPAL_12068	The modules of the MCAL shall be initialized in a defined sequence	SWS_Gpt_00381
SRS_SPAL_12069	All drivers of the SPAL that wake up from a wake-up interrupt shall report the wake-up reason	SWS_Gpt_00209, SWS_Gpt_00292
SRS_SPAL_12075	All drivers with random streaming capabilities shall use application buffers	SWS_Gpt_00381
SRS_SPAL_12077	All drivers shall provide a non blocking implementation	SWS_Gpt_00381
SRS_SPAL_12078	The drivers shall be coded in a way that is most efficient in terms of memory and runtime resources	SWS_Gpt_00381
SRS_SPAL_12092	The driver's API shall be accessed by its handler or manager	SWS_Gpt_00381
SRS_SPAL_12125	All driver modules shall only initialize the configured resources	SWS_Gpt_00068
SRS_SPAL_12129	The ISRs shall be responsible for resetting the interrupt flags and calling the according notification function	SWS_Gpt_00206, SWS_Gpt_00327
SRS_SPAL_12163	All driver modules shall implement an interface for de-initialization	SWS_Gpt_00008, SWS_Gpt_00281
SRS_SPAL_12169	All driver modules that provide different operation modes shall provide a service for mode selection	SWS_Gpt_00151, SWS_Gpt_00288
SRS_SPAL_12263	The implementation of all driver modules shall allow the configuration of specific module parameter types at link time	SWS_Gpt_00357

SRS_SPAL_12265	Configuration data shall be kept constant	SWS_Gpt_00381
SRS_SPAL_12448	All driver modules shall have a specific behavior after a development error detection	SWS_Gpt_00332
SRS_SPAL_12461	Specific rules regarding initialization of controller registers shall apply to all driver implementations	SWS_Gpt_00352, SWS_Gpt_00353, SWS_Gpt_00354, SWS_Gpt_00355, SWS_Gpt_00356
SRS_SPAL_12462	The register initialization settings shall be published	SWS_Gpt_00381
SRS_SPAL_12463	The register initialization settings shall be combined and forwarded	SWS_Gpt_00381

7 Functional specification

7.1 General behavior

The GPT driver provides services for starting and stopping timer channels (logical timer instances assigned to a timer hardware), individual for each channel by calling of:

```
Gpt_StartTimer
Gpt_StopTimer
```

The "target time" is passed as a parameter to `Gpt_StartTimer`. So, for each start of a timer channel, the target time can be set individually.

The states and the state transitions of a timer channel are shown in Figure 2

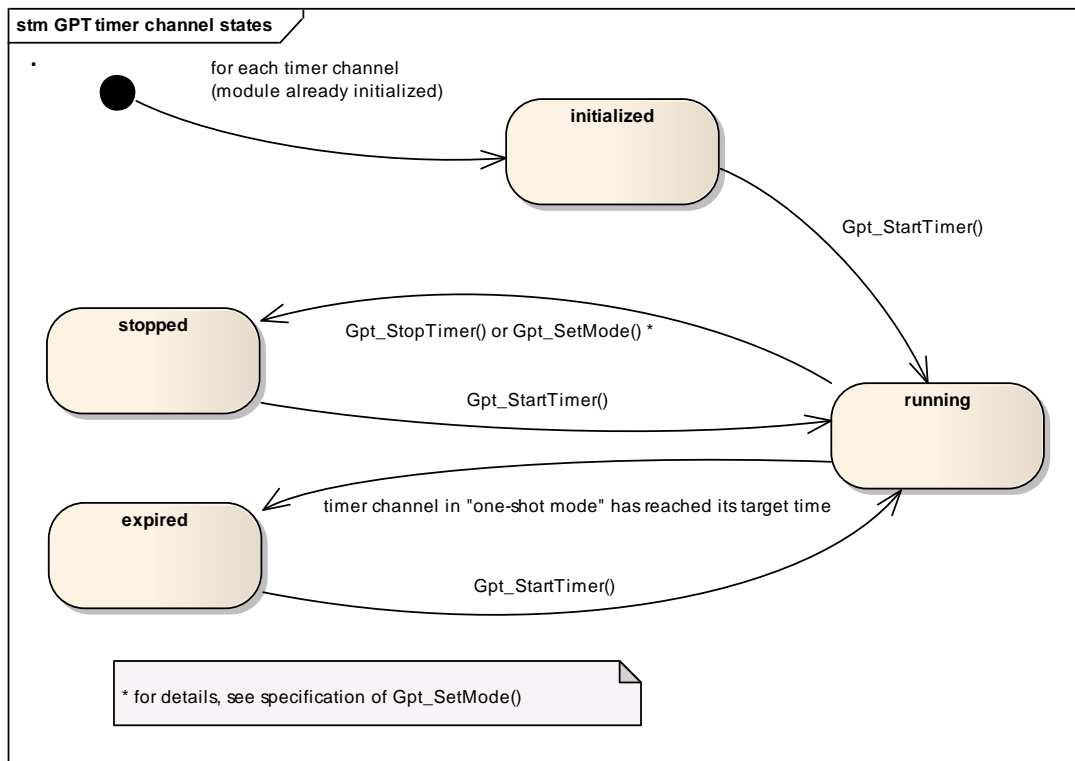

Figure 2: Channel states and state transitions

A timer channel can be configured in "one-shot mode" or in "continuous mode".

[SWS_Gpt_00329] [A timer channel starts counting at value zero.] ()

[SWS_Gpt_00185] [If a timer channel is configured in "one-shot mode":
If the timer has reached the target time (timer value = target time), the timer shall stop automatically and maintain its timer value unchanged. The channel state shall change from "running" to "expired".] ()

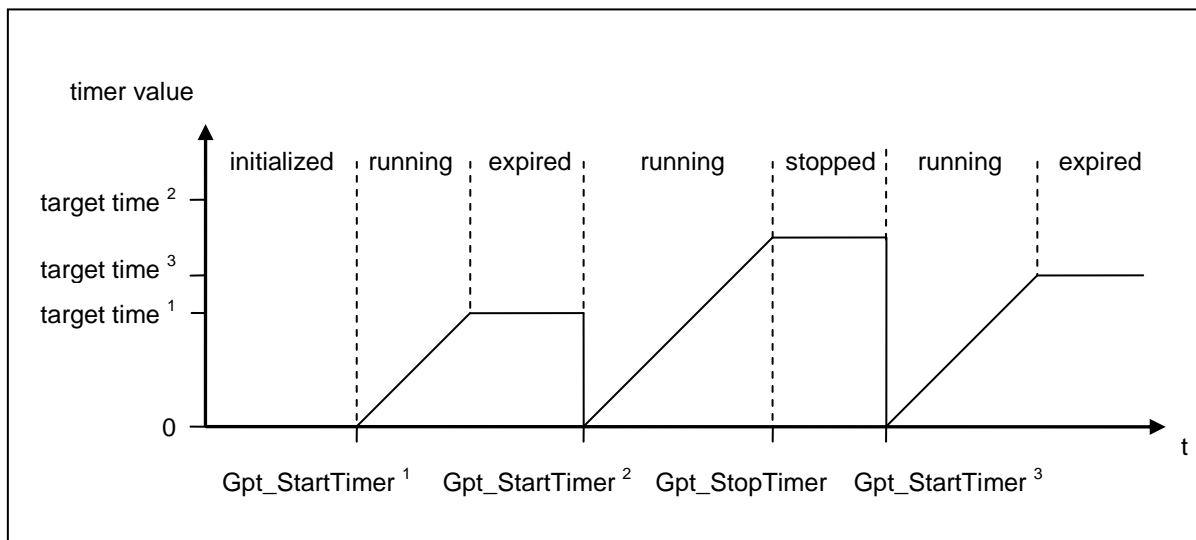

Figure 3: Timer channel in "one-shot mode"

[SWS_Gpt_00186] [If a timer channel is configured in "continuous mode":
If the timer has reached the target time (timer value = target time), the timer shall continue running with the value "0" at next timer tick. So, the time interval of the recurrence is: target time + 1. This interval shall be independently of implementation, e.g. interrupt delays.] ()

[SWS_Gpt_00330] [If a timer channel is configured in "continuous mode":
If supported by hardware, it shall be possible to realize a free running timer. This means: A timer which rolls over automatically by hardware, if the target time is set to the maximum value the timer is able to count (max value = $2^n - 1$, n=number of bits).] ()

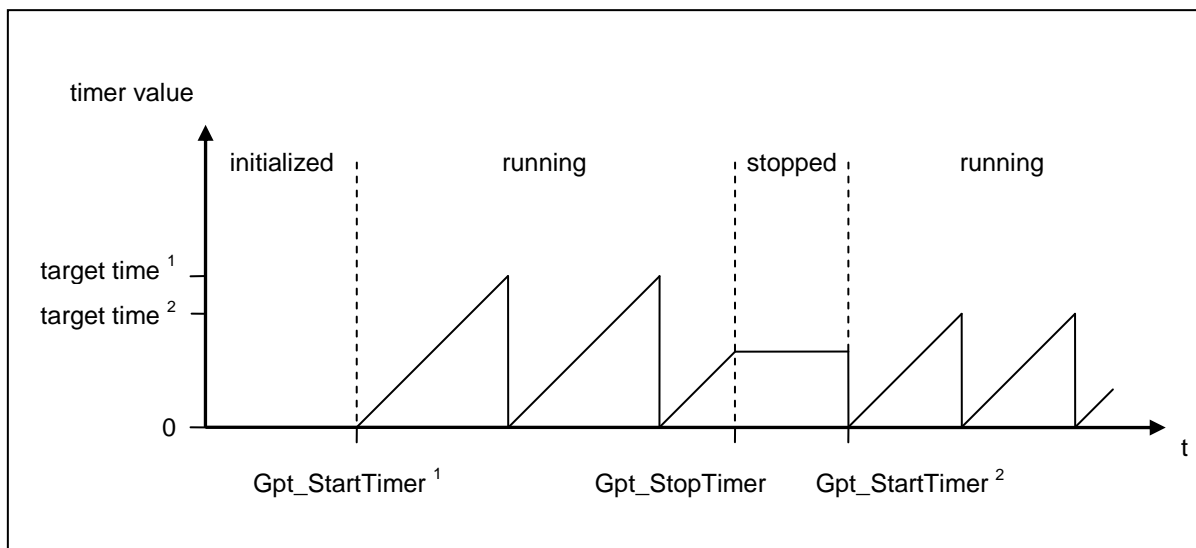

Figure 4: Timer channel in "continuous mode"

Both, the relative time elapsed and the time remaining can be queried by calling:

```
Gpt_GetTimeElapsed
Gpt_GetTimeRemaining
```

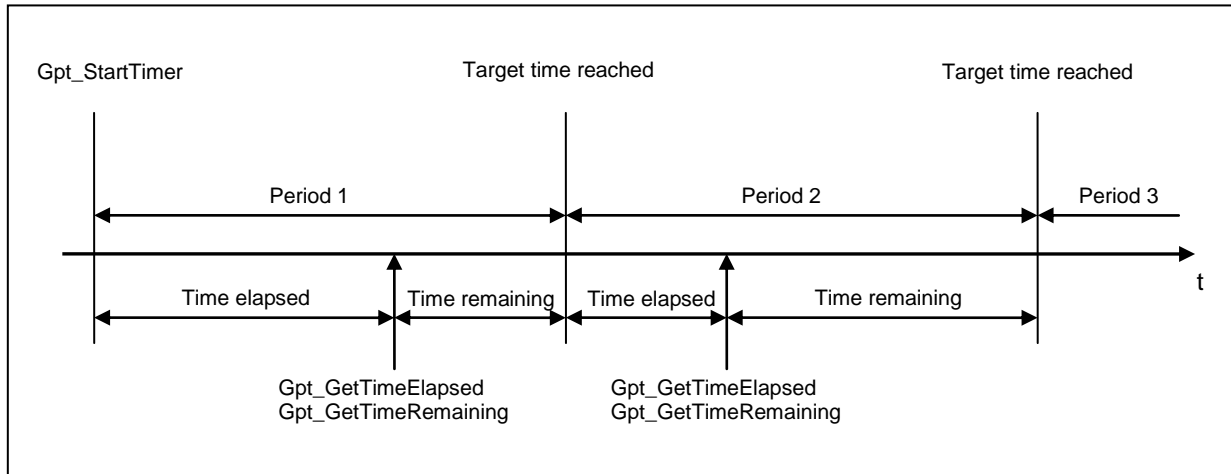

Figure 5: Querying of time elapsed / time remaining for a timer channel in "continuous mode"

[SWS_Gpt_00331] [If supported by hardware, a timer channel shall be able to be configured to call a notification function. If enabled, the function is called when the target time is reached (timer value = target time).] ()

Interrupt notifications can be enabled and disabled at runtime individually for each channel by calling of:

```
Gpt_EnableNotification
Gpt_DisableNotification
```

[SWS_Gpt_00127] [If supported by hardware, a timer channel shall be able to be configured as wakeup source of the ECU. If enabled, the wakeup occurs when the target time is reached (timer value = target time).] (SRS_Gpt_13601)

Wakeup interrupts can be enabled and disabled at runtime individually for each channel by calling of:

```
Gpt_EnableWakeup
Gpt_DisableWakeup
```

After initialization the GPT driver is in "normal mode". A wakeup interrupt can only occur when the driver is switched to "sleep mode". The operation mode can be set by calling of:

```
Gpt_SetMode
```

For a detailed description on wakeup handling please refer to the ECU State Manager specification [8].

The operation modes and the possible mode transitions of the GPT driver are shown in Figure 6.

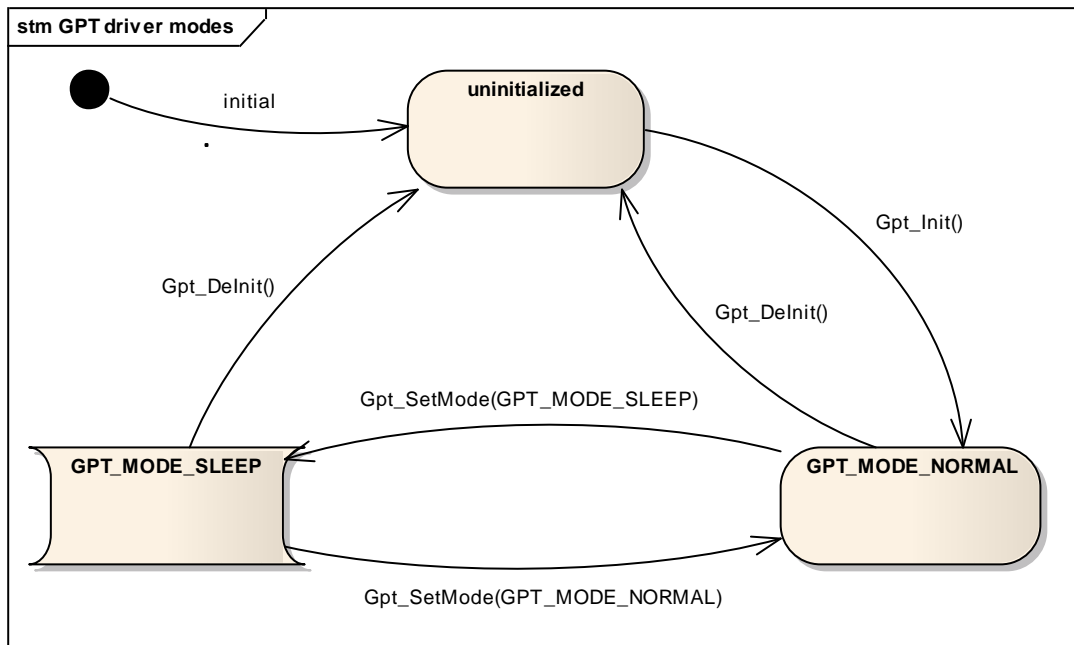

Figure 6: GPT driver modes

7.2 GPT Predef Timers

Beside the possibility to configure individual timer channels with individual properties, some GPT Predef Timers are defined. The API specified for “GPT timer channels” can not be used for GPT Predef Timers.

[SWS_Gpt_00382] | A GPT Predef Timer is a free running up counter (user point of view). If the timer has reached the maximum value (max value = $2^n - 1$, n =number of bits), the timer shall continue running with the value "0" at next timer tick. | (SRS_Gpt_13604)

[SWS_Gpt_00383] | Types of GPT Predef Timers

Name of GPT Predef Timer	Tick duration	Maximum tick value	Number of bits	Maximum time span (circa values)
GPT_PREDEF_TIMER_1US_16BIT	1 μ s	65535	16 bit	65 ms
GPT_PREDEF_TIMER_1US_24BIT		16777215	24 bit	16 s
GPT_PREDEF_TIMER_1US_32BIT		4294967295	32 bit	71 minutes
GPT_PREDEF_TIMER_100US_32BIT	100 μ s	4294967295	32 bit	4.9 days

| (SRS_Gpt_13605)

[SWS_Gpt_00384] | A GPT Predef Timer shall have a maximum tick tolerance of +/- 1 tick to ensure accuracy of time based functionality. | ()

Which GPT Predef Timer(s) can be enabled depends on clock and available timer hardware (prescaler, width of timer register). It is recommended to enable all GPT Predef Timers to ensure compatibility of time based functionality for all platforms.

It is recommended to use one hardware timer per tick duration and to supply the hardware timer directly with the clock source " $f_{\text{clock}} = 1 / (\text{tick duration})$ " by good choice of clock and prescaler(s). By this, the values of the timer counter register can be used directly without any need of adaptation (computation) for performance reasons. A lower bit timer can be derived from a higher bit timer by a simple software mask operation.

For implementation of GPT Predef Timers, special hardware features may be used:

- Timers may be cascaded asynchronously to use a timer as a prescaler
- Timers may be cascaded synchronously to extend the timer range (number of bits)
- Timers with bit number greater than 32 bit may be used
- Assembler code may be used to perform 64 bit arithmetic, if necessary GPT internal, e.g. if a 48 bit timer with tick duration 250 ns or 1 μ s is used for all GPT Predef Timers

[SWS_Gpt_00385] [It shall be possible to configure which GPT Predef Timers are enabled.] (SRS_Gpt_13606)

[SWS_Gpt_00386] [If a GPT Predef Timer is enabled, the timer(s) with the same tick duration and lower bit number(s) shall be enabled also.] ()

Implementation specific configuration parameters are allowed if needed, e.g. to select the used hardware unit.

All enabled GPT Predef Timers run after calling of:

Gpt_Init ([SWS Gpt 00390](#))
Gpt_SetMode(GPT_MODE_NORMAL) ([SWS Gpt 00392](#))

All enabled GPT Predef Timers are stopped by calling of:

Gpt_DeInit ([SWS Gpt 00391](#))
Gpt_SetMode(GPT_MODE_SLEEP) ([SWS Gpt 00393](#))

The current time value of the GPT Predef Timers can be got by calling of:

Gpt_GetPredefTimerValue ([SWS Gpt 00394](#))

7.3 Version checking

For details refer to the chapter 5.1.8 "Version Check" in *SWS_BSWGeneral*.

7.4 Error classification

7.4.1 Development Errors

<i>ID</i>	<i>Type of error</i>	<i>Relevance</i>	<i>Related error code</i>	<i>Value [hex]</i>
SWS_Gpt_00345	API service called without module initialization	Development	GPT_E_UNINIT	0x0A
SWS_Gpt_00346	API service called when timer channel is still busy (running)	Development	GPT_E_BUSY	0x0B
SWS_Gpt_00387	API service called when driver is in wrong mode	Development	GPT_E_MODE	0x0C
SWS_Gpt_00347	API service for initialization called when already initialized	Development	GPT_E_ALREADY_INITIALIZED	0x0D
SWS_Gpt_00404	API error return code: Init function failed	Development	GPT_E_INIT_FAILED	0x0E
SWS_Gpt_00348	API parameter checking: invalid channel	Development	GPT_E_PARAM_CHANNEL	0x14
SWS_Gpt_00349	API parameter checking: invalid value	Development	GPT_E_PARAM_VALUE	0x15
SWS_Gpt_00350	API parameter checking: invalid pointer	Development	GPT_E_PARAM_POINTER	0x16
SWS_Gpt_00388	API parameter checking: invalid Predef Timer	Development	GPT_E_PARAM_PREDEF_TIMER	0x17
SWS_Gpt_00351	API parameter checking: invalid mode	Development	GPT_E_PARAM_MODE	0x1F

Table 3: Development Error Tables

7.4.2 Runtime Errors

There are no runtime errors.

7.4.3 Transient Faults

There are no transient faults.

7.4.4 Production Errors

There are no production errors.

7.4.5 Extended Production Errors

There are no extended production errors.

7.5 Error detection

[SWS_Gpt_00332] [If the `GptDevErrorDetect` switch is enabled:
When a development error occurs the corresponding GPT function shall skip the desired functionality (leave service without any action).] (SRS_SPAL_12448)

7.6 Debugging

The following requirements deal with the definition of variables and the description of debug information.

[SWS_Gpt_00337] {OBSOLETE} [The operation mode of the GPT driver and the state of each timer channel shall be available for debugging.] ()

Comment: The operation mode of the GPT driver and the state of each timer channel is only meaningful when the module is initialized.

8 API specification

8.1 Imported types

In this chapter all types included from the following files are listed:

[SWS_Gpt_00278] [

Module	Imported Type
Dem	Dem_EventIdType
	Dem_EventStatusType
EcuM	EcuM_WakeupSourceType
Std_Types	Std_ReturnType
	Std_VersionInfoType

] (SRS_BSW_00348)

8.2 Type Definitions

8.3 Error notification

For details refer to the chapter 7.4 “Error notification” in *SWS_BSWGeneral*.

8.3.1 Gpt_ConfigType

[SWS_Gpt_00357] [

Name:	Gpt_ConfigType	
Type:	Structure	
Range:	--	Implementation specific configuration data structure, see chapter 10 for configurable parameters.
Description:	This is the type of the data structure including the configuration set required for initializing the GPT timer unit.	

] (SRS_BSW_00404, SRS_BSW_00405, SRS_BSW_00438, SRS_BSW_00305, SRS_BSW_00414, SRS_SPAL_12263)

8.3.2 Gpt_ChannelType

[SWS_Gpt_00358] [

Name:	Gpt_ChannelType	
Type:	uint	
Range:	--	-- Implementation specific. But not all values may be valid within this type. This type shall be chosen in order to have the most efficient implementation on a specific micro controller platform.
Description:	Numeric ID of a GPT channel.	

] (SRS_BSW_00305)

8.3.3 Gpt_ValueType

[SWS_Gpt_00359] [

Name:	Gpt_ValueType	
Type:	uint	
Range:	--	-- The range of this type is μ C dependent (width of the timer register) and has to be described by the supplier.
Description:	Type for reading and setting the timer values (in number of ticks).	

] (SRS_BSW_00305, SRS_SPAL_12063, SRS_Gpt_12328)

8.3.4 Gpt_ModeType

[SWS_Gpt_00360] [

Name:	Gpt_ModeType	
Type:	Enumeration	
Range:	GPT_MODE_NORMAL	Normal operation mode of the GPT
	GPT_MODE_SLEEP	Operation for reduced power operation mode. In sleep mode only wakeup capable channels are available.
Description:	Modes of the GPT driver.	

] (SRS_BSW_00441, SRS_BSW_00305)

8.3.5 Gpt_PredefTimerType

[SWS_Gpt_00389] [

Name:	Gpt_PredefTimerType	
Type:	Enumeration	
Range:	GPT_PREDEF_TIMER_1US_16BIT	GPT Predef Timer with tick duration 1 μ s and range 16bit
	GPT_PREDEF_TIMER_1US_24BIT	GPT Predef Timer with tick duration 1 μ s and range 24bit
	GPT_PREDEF_TIMER_1US_32BIT	GPT Predef Timer with tick duration 1 μ s and range 32bit
	GPT_PREDEF_TIMER_100US_32BIT	GPT Predef Timer with tick duration 100 μ s and range 32bit
Description:	Type for GPT Predef Timers	

] (SRS_Gpt_13605)

8.4 Function definitions

This is a list of functions provided for upper layer modules.

8.4.1 Gpt_GetVersionInfo

[SWS_Gpt_00279] [

Service name:	Gpt_GetVersionInfo
Syntax:	void Gpt_GetVersionInfo(Std_VersionInfoType* VersionInfoPtr)

Service ID[hex]:	0x00
Sync/Async:	Synchronous
Reentrancy:	Reentrant
Parameters (in):	None
Parameters (inout):	None
Parameters (out):	VersionInfoPtr Pointer to where to store the version information of this module.
Return value:	None
Description:	Returns the version information of this module.

] (SRS_BSW_00407)

[SWS_Gpt_00338] | If default error detection for the GPT module is enabled:
If the parameter `VersionInfoPtr` is a null pointer, the function
`Gpt_GetVersionInfo` shall raise the error `GPT_E_PARAM_POINTER`. |
(SRS_BSW_00323)

8.4.2 Gpt_Init

[SWS_Gpt_00280] |

Service name:	Gpt_Init
Syntax:	<pre>void Gpt_Init(const Gpt_ConfigType* ConfigPtr)</pre>
Service ID[hex]:	0x01
Sync/Async:	Synchronous
Reentrancy:	Non Reentrant
Parameters (in):	ConfigPtr Pointer to a selected configuration structure
Parameters (inout):	None
Parameters (out):	None
Return value:	None
Description:	Initializes the GPT driver.

] (SRS_BSW_00404, SRS_BSW_00405, SRS_BSW_00438, SRS_BSW_00101, SRS_BSW_00358, SRS_BSW_00414, SRS_SPAL_12057)

[SWS_Gpt_00006] | The function `Gpt_Init` shall initialize the hardware timer module according to a configuration set referenced by `ConfigPtr`. |
(SRS_BSW_00101, SRS_SPAL_12057)

[SWS_Gpt_00107] | The function `Gpt_Init` shall disable all interrupt notifications, controlled by the GPT driver. | ()

[SWS_Gpt_00068] | The function `Gpt_Init` shall only initialize the configured resources. Resources that are not configured in the configuration file shall not be touched. | (SRS_SPAL_12125)

The following rules regarding initialization of controller registers shall apply to this driver implementation:

- **[SWS_Gpt_00352]** | If the hardware allows for only one usage of the register, the driver module implementing that functionality is responsible for initializing the register. | (SRS_SPAL_12461)

- **[SWS_Gpt_00353]** [If the register can affect several hardware modules and if it is an I/O register it shall be initialized by the PORT driver.]
(SRS_SPAL_12461)
- **[SWS_Gpt_00354]** [If the register can affect several hardware modules and if it is not an I/O register it shall be initialized by the MCU driver.]
(SRS_SPAL_12461)
- **[SWS_Gpt_00355]** [One-time writable registers that require initialization directly after reset shall be initialized by the startup code.]
(SRS_SPAL_12461)
- **[SWS_Gpt_00356]** [All other registers shall be initialized by the startup code.]
(SRS_SPAL_12461)

[SWS_Gpt_00307] [If Default Error Tracer for the GPT module is enabled: If the GPT driver is not in operation mode "uninitialized", the function `Gpt_Init` shall raise the error `GPT_E_ALREADY_INITIALIZED`.] ()

[SWS_Gpt_00258] [The function `Gpt_Init` shall disable all wakeup interrupts, controlled by the GPT driver.] ()

[SWS_Gpt_00339] [The function `Gpt_Init` shall set the operation mode of the GPT driver to "normal mode". This leads to a behavior like `Gpt_SetMode` is called with parameter `GPT_MODE_NORMAL`.] ()

[SWS_Gpt_00309] [A re-initialization of the GPT driver by executing the `Gpt_Init` function requires a de-initialization before by executing a `Gpt_DeInit`.] ()

[SWS_Gpt_00390] [The function `Gpt_Init` shall start all enabled GPT Predef Timers at value "0".] (SRS_Gpt_13607)

8.4.3 Gpt_DeInit

[SWS_Gpt_00281] [

Service name:	Gpt_DeInit
Syntax:	<pre>void Gpt_DeInit(void)</pre>
Service ID[hex]:	0x02
Sync/Async:	Synchronous
Reentrancy:	Non Reentrant
Parameters (in):	None
Parameters (inout):	None
Parameters (out):	None
Return value:	None
Description:	Deinitializes the GPT driver.

] (SRS_BSW_00336, SRS_SPAL_12163, SRS_Gpt_12116)

[SWS_Gpt_00008] | The function `Gpt_DeInit` shall deinitialize the hardware used by the GPT driver (depending on configuration) to the power on reset state. Values of registers which are not writeable are excluded. It's the responsibility of the hardware design that the state does not lead to undefined activities in the μ C. |
(SRS_BSW_00336, SRS_SPAL_12163, SRS_Gpt_12116)

[SWS_Gpt_00105] | The function `Gpt_DeInit` shall disable all interrupt notifications and wakeup interrupts, controlled by the GPT driver. | ()

[SWS_Gpt_00162] | The function `Gpt_DeInit` shall influence only the peripherals, which are allocated by the static configuration. | (SRS_Gpt_12116)

[SWS_Gpt_00308] | If a postbuild multiple selectable configuration variant was used, the function `Gpt_DeInit` shall further influence only the peripherals, which are allocated by the runtime configuration set passed by the previous call of the function `Gpt_Init`. | (SRS_Gpt_12116)

[SWS_Gpt_00194] | The function `Gpt_DeInit` shall be pre compile time configurable `On/Off` by the configuration parameter: `GptDeInitApi`. |
(SRS_BSW_00171)

[SWS_Gpt_00363] | The function `Gpt_DeInit` shall set the operation mode of the GPT driver to "uninitialized". | ()

[SWS_Gpt_00234] | If default error detection for the GPT module is enabled: If any timer channel is in state "running", the function `Gpt_DeInit` shall raise the error `GPT_E_BUSY`. | ()

[SWS_Gpt_00220] | If default error detection for the GPT module is enabled: If the driver is not initialized, the function `Gpt_DeInit` shall raise the error `GPT_E_UNINIT`. | (SRS_BSW_00406)

[SWS_Gpt_00391] | The function `Gpt_DeInit` shall stop all enabled GPT Predef Timers. | (SRS_Gpt_13607)

8.4.4 Gpt_GetTimeElapsed

[SWS_Gpt_00282] |

Service name:	Gpt_GetTimeElapsed	
Syntax:	Gpt_ValueType Gpt_GetTimeElapsed(Gpt_ChannelType Channel)	
Service ID[hex]:	0x03	
Sync/Async:	Synchronous	
Reentrancy:	Reentrant	
Parameters (in):	Channel	Numeric identifier of the GPT channel.
Parameters	None	

(inout):	
Parameters (out):	None
Return value:	Gpt_ValueType Elapsed timer value (in number of ticks)
Description:	Returns the time already elapsed.

] (SRS_Gpt_12117)

[SWS_Gpt_00010] [The function `Gpt_GetTimeElapsed` shall return the time already elapsed. When the channel is in mode "one-shot mode", this is the value relative to the point in time, the channel has been started.] (SRS_Gpt_12117)

[SWS_Gpt_00361] [When the channel is in mode "continuous mode", the return value of `Gpt_GetTimeElapsed` is the value relative to the last recurrence (target time reached) or to the start of the channel before the first recurrence occurs.] ()

[SWS_Gpt_00295] [If the function `Gpt_GetTimeElapsed` is called on a timer channel in state "initialized" (channel started never before), the function shall return the value "0".] ()

[SWS_Gpt_00297] [If the function `Gpt_GetTimeElapsed` is called on a timer channel in state "stopped", the function shall return the time value at the moment of stopping.] ()

[SWS_Gpt_00299] [If the function `Gpt_GetTimeElapsed` is called on a channel configured for "one-shot mode" in state "expired" (timer has reached the target time), the function shall return the target time.] ()

[SWS_Gpt_00113] [The function `Gpt_GetTimeElapsed` shall be fully reentrant, this means even for the same timer channel.] ()

[SWS_Gpt_00195] [The function `Gpt_GetTimeElapsed` shall be pre compile time configurable On/Off by the configuration parameter: `GptTimeElapsedApi`.] (SRS_BSW_00171)

[SWS_Gpt_00222] [If default error detection for the GPT module is enabled: If the driver is not initialized, the function `Gpt_GetTimeElapsed` shall raise the error `GPT_E_UNINIT` and shall return the value "0".] (SRS_BSW_00406)

[SWS_Gpt_00210] [If default error detection for the GPT module is enabled: If the parameter `Channel` is invalid (not within the range specified by configuration), the function `Gpt_GetTimeElapsed` shall raise the development error `GPT_E_PARAM_CHANNEL` and shall return the value "0".] ()

State / Circumstance	Timer channel state	Return value	Development error (if enabled)
Driver uninitialized	-	0	GPT_E_UNINIT
Driver initialized	initialized	0	-
	running	elapsed time	-

	stopped	elapsed time at moment of stopping	-
	expired (only one-shot mode)	target time	-
Invalid parameter "Channel"	all	0	GPT_E_PARAM_CHANNEL

Table 4: Summary: Return values and DET errors of Gpt_GetTimeElapsed

8.4.5 Gpt_GetTimeRemaining

[SWS_Gpt_00283] [

Service name:	Gpt_GetTimeRemaining		
Syntax:	Gpt_ValueType Gpt_GetTimeRemaining(Gpt_ChannelType Channel)		
Service ID[hex]:	0x04		
Sync/Async:	Synchronous		
Reentrancy:	Reentrant		
Parameters (in):	Channel	Numeric identifier of the GPT channel.	
Parameters (inout):	None		
Parameters (out):	None		
Return value:	Gpt_ValueType	Remaining timer value (in number of ticks)	
Description:	Returns the time remaining until the target time is reached.		

] (SRS_Gpt_12117)

[SWS_Gpt_00083] [The function `Gpt_GetTimeRemaining` shall return the timer value remaining until the target time will be reached next time. The remaining time is the "target time" minus the time already elapsed.] (SRS_Gpt_12117)

[SWS_Gpt_00301] [If the function `Gpt_GetTimeRemaining` is called on a timer channel in state "initialized" (channel started never before), the function shall return the value "0".] ()

[SWS_Gpt_00303] [If the function `Gpt_GetTimeRemaining` is called on a timer channel in state "stopped", the function shall return the remaining time value at the moment of stopping.] ()

[SWS_Gpt_00305] [If the function `Gpt_GetTimeRemaining` is called on a channel configured for "one-shot mode" in state "expired" (timer has reached the target time), the function shall return the value "0".] ()

[SWS_Gpt_00114] [The function `Gpt_GetTimeRemaining` shall be fully reentrant, this means even for the same timer channel.] ()

[SWS_Gpt_00196] [The function `Gpt_GetTimeRemaining` shall be pre compile time configurable On/Off by the configuration parameter: `GptTimeRemainingApi`.] (SRS_BSW_00171)

[SWS_Gpt_00223] [If default error detection for the GPT module is enabled:
If the driver is not initialized, the function `Gpt_GetTimeRemaining` shall raise the error `GPT_E_UNINIT` and shall return the value "0".] (SRS_BSW_00406)

[SWS_Gpt_00211] [If default error detection for the GPT module is enabled:
If the parameter `Channel` is invalid (not within the range specified by configuration), the function `Gpt_GetTimeRemaining` shall raise the error `GPT_E_PARAM_CHANNEL` and shall return the value "0".] ()

State / Circumstance	Timer channel state	Return value	Development error (if enabled)
Driver uninitialized	-	0	GPT_E_UNINIT
Driver initialized	initialized	0	-
	running	remaining time	-
	stopped	remaining time at moment of stopping	-
	expired (only one-shot mode)	0	-
Invalid parameter "Channel"	all	0	GPT_E_PARAM_CHANNEL

Table 5: Summary: Return values and DET errors of `Gpt_GetTimeRemaining`

8.4.6 `Gpt_StartTimer`

[SWS_Gpt_00284] [

Service name:	<code>Gpt_StartTimer</code>	
Syntax:	<pre>void Gpt_StartTimer(Gpt_ChannelType Channel, Gpt_ValueType Value)</pre>	
Service ID[hex]:	0x05	
Sync/Async:	Synchronous	
Reentrancy:	Reentrant (but not for the same timer channel)	
Parameters (in):	Channel	Numeric identifier of the GPT channel.
	Value	Target time in number of ticks.
Parameters (inout):	None	
Parameters (out):	None	
Return value:	None	
Description:	Starts a timer channel.	

] (SRS_Gpt_12128)

[SWS_Gpt_00274] [The function `Gpt_StartTimer` shall start the selected timer channel with a defined target time.] (SRS_Gpt_12128)

[SWS_Gpt_00275] [If configured and enabled, an interrupt notification or a wakeup interrupt occurs, when the target time is reached.] (SRS_Gpt_12128)

[SWS_Gpt_00115] | The function `Gpt_StartTimer` shall be reentrant, if the timer channels used in concurrent calls are different. | ()

[SWS_Gpt_00364] | The state of the selected timer channel shall be changed to "running" if `Gpt_StartTimer` is called. | ()

[SWS_Gpt_00212] | If default error detection for the GPT module is enabled: If the parameter `Channel` is invalid (not within the range specified by configuration), the function `Gpt_StartTimer` shall raise the error `GPT_E_PARAM_CHANNEL`. | ()

[SWS_Gpt_00218] | If default error detection for the GPT module is enabled: The function `Gpt_StartTimer` shall raise the error `GPT_E_PARAM_VALUE` if the parameter `Value` is "0" or not within the allowed range (exceeding the maximum timer resolution). | (SRS_BSW_00323)

[SWS_Gpt_00224] | If default error detection for the GPT module is enabled: If the driver is not initialized, the function `Gpt_StartTimer` shall raise the error `GPT_E_UNINIT`. | (SRS_BSW_00406)

[SWS_Gpt_00084] | If default error detection for the GPT module is enabled: If the function `Gpt_StartTimer` is called on a channel in state "running", the function shall raise the error `GPT_E_BUSY`. | ()

8.4.7 Gpt_StopTimer

[SWS_Gpt_00285] |

Service name:	Gpt_StopTimer	
Syntax:	void Gpt_StopTimer(Gpt_ChannelType Channel)	
Service ID[hex]:	0x06	
Sync/Async:	Synchronous	
Reentrancy:	Reentrant (but not for the same timer channel)	
Parameters (in):	Channel	Numeric identifier of the GPT channel.
Parameters (inout):	None	
Parameters (out):	None	
Return value:	None	
Description:	Stops a timer channel.	

| (SRS_Gpt_12119)

[SWS_Gpt_00013] | The function `Gpt_StopTimer` shall stop the selected timer channel. | (SRS_Gpt_12119)

[SWS_Gpt_00343] | The state of the selected timer channel shall be changed to "stopped" if `Gpt_StopTimer` is called. | ()

[SWS_Gpt_00099] | If default error detection for the GPT module is enabled: If the function `Gpt_StopTimer` is called on a channel in state "initialized", "stopped" or "expired", the function shall not raise a development error. | ()

[SWS_Gpt_00344] [If the function `Gpt_StopTimer` is called on a channel in state "initialized", "stopped" or "expired", the function shall leave without any action (no change of the channel state).] ()

[SWS_Gpt_00116] [The function `Gpt_StopTimer` shall be reentrant, if the timer channels used in concurrent calls are different.] ()

[SWS_Gpt_00213] [If default error detection for the GPT module is enabled: If the parameter `Channel` is invalid (not within the range specified by configuration), the function `Gpt_StopTimer` shall raise the error `GPT_E_PARAM_CHANNEL`.] ()

[SWS_Gpt_00225] [If default error detection for the GPT module is enabled: If the driver is not initialized, the function `Gpt_StopTimer` shall raise the error `GPT_E_UNINIT`.] (SRS_BSW_00406)

8.4.8 Gpt_EnableNotification

[SWS_Gpt_00286] [

Service name:	Gpt_EnableNotification
Syntax:	void Gpt_EnableNotification(Gpt_ChannelType Channel)
Service ID[hex]:	0x07
Sync/Async:	Synchronous
Reentrancy:	Reentrant (but not for the same timer channel)
Parameters (in):	Channel Numeric identifier of the GPT channel.
Parameters (inout):	None
Parameters (out):	None
Return value:	None
Description:	Enables the interrupt notification for a channel (relevant in normal mode).

] (SRS_Gpt_12121)

[SWS_Gpt_00014] [The function `Gpt_EnableNotification` shall enable the interrupt notification of the referenced channel configured for notification (see also [SWS_Gpt_00233](#)). The function shall save an attribute like "notification enabled" of the channel.] (SRS_SPAL_00157, SRS_SPAL_12067, SRS_Gpt_12121)

Comment: This attribute affects the interrupt notification always when the driver is in "normal mode". In "sleep mode" the attribute has no influence.

[SWS_Gpt_00117] [The function `Gpt_EnableNotification` shall be reentrant, if the timer channels used in concurrent calls are different.] ()

[SWS_Gpt_00199] [The function `Gpt_EnableNotification` shall be pre compile time configurable `On/Off` by the configuration parameter: `GptEnableDisableNotificationApi`.] (SRS_BSW_00171)

[SWS_Gpt_00226] | If default error detection for the GPT module is enabled:
If the driver is not initialized, the function `Gpt_EnableNotification` shall raise the error `GPT_E_UNINIT.` | (SRS_BSW_00406)

[SWS_Gpt_00214] | If default error detection for the GPT module is enabled:
If the parameter `Channel` is invalid (not within the range specified by configuration), the function `Gpt_EnableNotification` shall raise the error `GPT_E_PARAM_CHANNEL.` | ()

[SWS_Gpt_00377] | If default error detection for the GPT module is enabled:
If no valid notification function is configured (`GptNotification`), the function `Gpt_EnableNotification` shall raise the error `GPT_E_PARAM_CHANNEL.` | ()

8.4.9 Gpt_DisableNotification

[SWS_Gpt_00287] |

Service name:	Gpt_DisableNotification
Syntax:	void Gpt_DisableNotification(Gpt_ChannelType Channel)
Service ID[hex]:	0x08
Sync/Async:	Synchronous
Reentrancy:	Reentrant (but not for the same timer channel)
Parameters (in):	Channel Numeric identifier of the GPT channel.
Parameters (inout):	None
Parameters (out):	None
Return value:	None
Description:	Disables the interrupt notification for a channel (relevant in normal mode).

| (SRS_Gpt_12122)

[SWS_Gpt_00015] | The function `Gpt_DisableNotification` shall disable the interrupt notification of the referenced channel configured for notification (see also [SWS_Gpt_00233](#)). The function shall save an attribute like "notification disabled" of the channel. | (SRS_SPAL_00157, SRS_Gpt_12122, SRS_SPAL_12067)

Comment: This attribute affects the interrupt notification always when the driver is in "normal mode". In "sleep mode" the attribute has no influence.

[SWS_Gpt_00118] | The function `Gpt_DisableNotification` shall be reentrant, if the timer channels used in concurrent calls are different. | ()

[SWS_Gpt_00200] | The function `Gpt_DisableNotification` shall be pre compile time configurable On/Off by the configuration parameter: `GptEnableDisableNotificationApi.` | (SRS_BSW_00171)

[SWS_Gpt_00227] | If default error detection for the GPT module is enabled:
If the driver is not initialized, the function `Gpt_DisableNotification` shall raise the error `GPT_E_UNINIT.` | (SRS_BSW_00406)

[SWS_Gpt_00217] [If default error detection for the GPT module is enabled:
If the parameter `Channel` is invalid (not within the range specified by configuration),
the function `Gpt_DisableNotification` shall raise the error
`GPT_E_PARAM_CHANNEL.`] ()

[SWS_Gpt_00379] [If default error detection for the GPT module is enabled:
If no valid notification function is configured (`GptNotification`), the function
`Gpt_DisableNotification` shall raise the error `GPT_E_PARAM_CHANNEL.`] ()

8.4.10 Gpt_SetMode

[SWS_Gpt_00288] [

Service name:	Gpt_SetMode	
Syntax:	void Gpt_SetMode(Gpt_ModeType Mode)	
Service ID[hex]:	0x09	
Sync/Async:	Synchronous	
Reentrancy:	Non Reentrant	
Parameters (in):	Mode	GPT_MODE_NORMAL: Normal operation mode of the GPT driver. GPT_MODE_SLEEP: Sleep mode of the GPT driver (wakeup capable). See also <code>Gpt_ModeType</code> .
Parameters (inout):	None	
Parameters (out):	None	
Return value:	None	
Description:	Sets the operation mode of the GPT.	

] (SRS_SPAL_12169, SRS_Gpt_13603)

[SWS_Gpt_00151] [The function `Gpt_SetMode` shall set the operation mode of the
GPT driver to the given mode parameter.] (SRS_SPAL_12169, SRS_Gpt_13603)

[SWS_Gpt_00255] [The function `Gpt_SetMode` is only available if the configuration
parameter `GptReportWakeupSource` is enabled.] ()

[SWS_Gpt_00152] [If the parameter `Mode` has the value `GPT_MODE_NORMAL`:
The function `Gpt_SetMode` shall enable the interrupt notification for all channels
which are configured for notification and the notification is enabled (stored attribute)
via the function `Gpt_EnableNotification` prior. All other interrupt notifications
shall be disabled.] (SRS_Gpt_13603)

[SWS_Gpt_00153] [If the parameter `Mode` has the value `GPT_MODE_SLEEP`:
The function `Gpt_SetMode` shall enable the wakeup interrupts for all channels which
are configured for wakeup and the wakeup is enabled (stored attribute) via the
function `Gpt_EnableWakeup` prior. All other wakeup interrupts shall be disabled.]
(SRS_Gpt_13603)

[SWS_Gpt_00164] [If the function `Gpt_SetMode` is called with parameter `Mode` has the value `GPT_MODE_SLEEP`: All timer channels in state "running" which are not configured for wakeup or not enabled for wakeup interruption (stored attribute) via `Gpt_EnableWakeup` shall be stopped and their state shall be changed to "stopped".] ()

[SWS_Gpt_00165] [If the parameter `Mode` has the value `GPT_MODE_NORMAL`, the function `Gpt_SetMode` shall not restart automatically the timer channels which have been stopped by entering the sleep mode.] ()

[SWS_Gpt_00341] [If the parameter has the value `GPT_MODE_SLEEP` the function `Gpt_SetMode` shall not start a wakeup timer automatically. First, the user shall call `Gpt_StartTimer` to start a wakeup timer, after this the user shall call `Gpt_SetMode` with parameter `GPT_MODE_SLEEP`.] ()

[SWS_Gpt_00228] [If default error detection for the GPT module is enabled: If the driver is not initialized, the function `Gpt_SetMode` shall raise the error `GPT_E_UNINIT`.] (SRS_BSW_00406)

[SWS_Gpt_00231] [If default error detection for the GPT module is enabled: The function `Gpt_SetMode` shall raise the error `GPT_E_PARAM_MODE` if the parameter `Mode` is invalid.] ()

[SWS_Gpt_00201] [The function `Gpt_SetMode` shall be pre compile time configurable On/Off by the configuration parameter: `GptWakeupFunctionalityApi`.] (SRS_BSW_00171)

[SWS_Gpt_00392] [If the parameter `Mode` has the value `GPT_MODE_NORMAL`: If the driver is in "sleep mode", the function `Gpt_SetMode` shall restart all enabled GPT Predef Timers at value "0".] (SRS_Gpt_13607)

[SWS_Gpt_00393] [If the parameter `Mode` has the value `GPT_MODE_SLEEP`: The function `Gpt_SetMode` shall stop all enabled GPT Predef Timers.] (SRS_Gpt_13607)

8.4.11 Gpt_DisableWakeup

[SWS_Gpt_00289] [

Service name:	Gpt_DisableWakeup	
Syntax:	void Gpt_DisableWakeup(Gpt_ChannelType Channel)	
Service ID[hex]:	0x0a	
Sync/Async:	Synchronous	
Reentrancy:	Reentrant (but not for the same timer channel)	
Parameters (in):	Channel	Numeric identifier of the GPT channel.
Parameters (inout):	None	

Parameters (out):	None
Return value:	None
Description:	Disables the wakeup interrupt of a channel (relevant in sleep mode).

] (SRS_Gpt_13602)

[SWS_Gpt_00159] [The function `Gpt_DisableWakeup` shall disable the wakeup interrupt of the referenced channel configured for wakeup. The function shall save an attribute like "wakeup disabled" of the channel.

Comment: This attribute affects the wakeup interrupt always when the driver is in "sleep mode". In "normal mode" the attribute has no influence.] (SRS_Gpt_13602)

[SWS_Gpt_00157] [The function `Gpt_DisableWakeup` is only feasible, if `GptReportWakeupSource` is statically configured available.] ()

[SWS_Gpt_00155] [The function `Gpt_DisableWakeup` shall be reentrant, if the timer channels used in concurrent calls are different.] ()

[SWS_Gpt_00202] [The function `Gpt_DisableWakeup` shall be pre compile time configurable On/Off by the configuration parameter: `GptWakeupFunctionalityApi`.] (SRS_BSW_00171)

[SWS_Gpt_00215] [If default error detection for the GPT module is enabled: If the parameter `Channel` is invalid (not within the range specified by configuration) or channel wakeup is not enabled by configuration (`GptEnableWakeup`), the function `Gpt_DisableWakeup` shall raise the error `GPT_E_PARAM_CHANNEL`.] ()

[SWS_Gpt_00229] [If default error detection for the GPT module is enabled: If the driver is not initialized, the function `Gpt_DisableWakeup` shall raise the error `GPT_E_UNINIT`.] (SRS_BSW_00406)

8.4.12 Gpt_EnableWakeup

[SWS_Gpt_00290] [

Service name:	<code>Gpt_EnableWakeup</code>
Syntax:	<code>void Gpt_EnableWakeup(Gpt_ChannelType Channel)</code>
Service ID[hex]:	0x0b
Sync/Async:	Synchronous
Reentrancy:	Reentrant (but not for the same timer channel)
Parameters (in):	Channel Numeric identifier of the GPT channel.
Parameters (inout):	None
Parameters (out):	None
Return value:	None
Description:	Enables the wakeup interrupt of a channel (relevant in sleep mode).

] (SRS_Gpt_13602)

[SWS_Gpt_00160] [The function `Gpt_EnableWakeup` shall enable the wakeup interrupt of the referenced channel configured for wakeup. The function shall save an attribute like "wakeup enabled" of the channel.] (SRS_Gpt_13602)

Comment: This attribute affects the wakeup interrupt always when the driver is in "sleep mode". In "normal mode" the attribute has no influence.

[SWS_Gpt_00158] [The function `Gpt_EnableWakeup` is only feasible, if `GptReportWakeupSource` is statically configured available.] ()

[SWS_Gpt_00156] [The function `Gpt_EnableWakeup` shall be reentrant, if the timer channels used in concurrent calls are different.] ()

[SWS_Gpt_00203] [The function `Gpt_EnableWakeup` shall be pre compile time configurable On/Off by the configuration parameter: `GptWakeupFunctionalityApi`.] (SRS_BSW_00171)

[SWS_Gpt_00230] [If default error detection for the GPT module is enabled: If the driver is not initialized, the function `Gpt_EnableWakeup` shall raise the error `GPT_E_UNINIT`.] (SRS_BSW_00406)

[SWS_Gpt_00216] [If default error detection for the GPT module is enabled: If the parameter `Channel` is invalid (not within the range specified by configuration) or channel wakeup is not enabled by configuration (`GptEnableWakeup`), the function `Gpt_EnableWakeup` shall raise the error `GPT_E_PARAM_CHANNEL`.] ()

8.4.13 Gpt_CheckWakeup

[SWS_Gpt_00328] [

Service name:	Gpt_CheckWakeup	
Syntax:	void Gpt_CheckWakeup(EcuM_WakeupSourceType WakeupSource)	
Service ID[hex]:	0x0c	
Sync/Async:	Synchronous	
Reentrancy:	Reentrant	
Parameters (in):	WakeupSource	Information on wakeup source to be checked. The associated GPT channel can be determined from configuration data.
Parameters (inout):	None	
Parameters (out):	None	
Return value:	None	
Description:	Checks if a wakeup capable GPT channel is the source for a wakeup event and calls the ECU state manager service <code>EcuM_SetWakeupEvent</code> in case of a valid GPT channel wakeup event.	

] ()

[SWS_Gpt_00321] [The function `Gpt_CheckWakeup` shall check if a wakeup capable GPT channel is the source for a wakeup event and call `EcuM_SetWakeupEvent` to indicate a valid timer wakeup event to the ECU State Manager [8].] ()

[SWS_Gpt_00322] [The function `Gpt_CheckWakeup` is only feasible, if `GptReportWakeupSource` is statically configured available.] ()

[SWS_Gpt_00323] [The function `Gpt_CheckWakeup` shall be reentrant, by reason of possible usage in concurrent interrupt service routines.] ()

[SWS_Gpt_00324] [The function `Gpt_CheckWakeup` shall be pre compile time configurable On/Off by the configuration parameter: `GptWakeupFunctionalityApi`.] ()

[SWS_Gpt_00325] [If default error detection for the GPT module is enabled: If the driver is not initialized, the function `Gpt_CheckWakeup` shall raise the error `GPT_E_UNINIT`.] (SRS_BSW_00406)

8.4.14 Gpt_GetPredefTimerValue

[SWS_Gpt_00394] [

Service name:	Gpt_GetPredefTimerValue	
Syntax:	<pre>Std_ReturnType Gpt_GetPredefTimerValue(Gpt_PredefTimerType PredefTimer, uint32* TimeValuePtr)</pre>	
Service ID[hex]:	0x0d	
Sync/Async:	Synchronous	
Reentrancy:	Reentrant	
Parameters (in):	PredefTimer	GPT Predef Timer
Parameters (inout):	None	
Parameters (out):	TimeValuePtr	Pointer to time value destination data in RAM
Return value:	Std_ReturnType	E_OK: no error has been detected E_NOT_OK: aborted due to errors
Description:	Delivers the current value of the desired GPT Predef Timer.	

] (SRS_Gpt_13608)

Note:

It is strongly recommended to check the return value of the function `Gpt_GetPredefTimerValue` on user software level. When `E_NOT_OK` is returned the time value - pointed by `TimeValuePtr` - may be invalid and must not be used.

[SWS_Gpt_00395] [The function `Gpt_GetPredefTimerValue` shall return the current value of the GPT Predef Timer passed by `PredefTimer`.] (SRS_Gpt_13608)

[SWS_Gpt_00396] [If the timer value of the function `Gpt_GetPredefTimerValue` is less than 32 bit (16bit or 24bit timer), the upper bits shall be filled with zero.] ()

[SWS_Gpt_00397] [The function `Gpt_GetPredefTimerValue` shall be fully reentrant, this means even for the same GPT Predef Timer.] (SRS_Gpt_13608)

[SWS_Gpt_00402] [If the GPT driver is not initialized, in “sleep mode” or the GPT Predef Timer is not enabled, the function `Gpt_GetPredefTimerValue` shall return `E_NOT_OK`.] (SRS_BSW_00406)

Note:

This is to inform user software if the hardware timer is not running, independent of default error detection enabled/disabled for the GPT module. The function `Gpt_GetPredefTimerValue` is used by the Time Service module which is part of the Services Layer. The user of the Time Service module shall have a chance to cope with missed timer support.

[SWS_Gpt_00398] [If default error detection for the GPT module is enabled: If the driver is not initialized, the function `Gpt_GetPredefTimerValue` shall raise the error `GPT_E_UNINIT`. Otherwise (if default error detection is not enabled), it shall return `E_NOT_OK`.] (SRS_BSW_00406)

[SWS_Gpt_00399] [If default error detection for the GPT module is enabled: If the parameter `PredefTimer` is invalid, the function `Gpt_GetPredefTimerValue` shall raise the development error `GPT_E_PARAM_PREDEF_TIMER`. Otherwise (if default error detection is not enabled), it shall return `E_NOT_OK`.] (SRS_BSW_00323)

[SWS_Gpt_00400] [If default error detection for the GPT module is enabled: If the GPT Predef Timer passed by the parameter `PredefTimer` is not enabled, the function `Gpt_GetPredefTimerValue` shall raise the development error `GPT_E_PARAM_PREDEF_TIMER`. Otherwise (if default error detection is not enabled), it shall return `E_NOT_OK`.] ()

[SWS_Gpt_00401] [If default error detection for the GPT module is enabled: If the driver is in "sleep mode", the function `Gpt_GetPredefTimerValue` shall raise the error `GPT_E_MODE`. Otherwise (if default error detection is not enabled), it shall return `E_NOT_OK`.] ()

[SWS_Gpt_00403] [If default error detection for the GPT module is enabled: If the parameter `TimeValuePtr` is a null pointer, the function `Gpt_GetPredefTimerValue` shall raise the development error `GPT_E_PARAM_POINTER`. Otherwise (if default error detection is not enabled), it shall return `E_NOT_OK`.] (SRS_BSW_00369, SRS_BSW_00323)

8.5 Call-back Notifications

Since the GPT is a driver module it doesn't provide any callback functions for lower layer modules.

8.6 Scheduled functions

None.

8.7 Expected Interfaces

In this chapter all interfaces required from other modules are listed.

8.7.1 Mandatory Interfaces

This chapter defines all interfaces, which are required to fulfill the core functionality of the module.

None.

8.7.2 Optional Interfaces

This chapter defines all interfaces, which are required to fulfill an optional functionality of the module.

<i>API function</i>	<i>Description</i>
Dem_ReportErrorStatus	Queues the reported events from the BSW modules (API is only used by BSW modules). The interface has an asynchronous behavior, because the processing of the event is done within the Dem main function. OBID Events Suppression shall be ignored for this computation.
Det_ReportError	Service to report development errors.
EcuM_CheckWakeup	This callout is called by the EcuM to poll a wakeup source. It shall also be called by the ISR of a wakeup source to set up the PLL and check other wakeup sources that may be connected to the same interrupt.
EcuM_SetWakeupEvent	Sets the wakeup event.

[SWS_Gpt_00326] [EcuM_CheckWakeup shall be called within the Interrupt Service Routine, servicing the GPT channel wakeup event on wakeup-capable channels.] ()

[SWS_Gpt_00327] [The ISR's, providing the wakeup events, shall be responsible for resetting the interrupt flags (if needed by hardware).] (SRS_SPAL_12129)

8.7.3 Configurable Interfaces

In this chapter all interfaces are listed where the target function could be configured. The target function is usually a call-back function. The names of these kinds of interfaces is not fixed because they are configurable.

8.7.3.1 GPT Notification

[SWS_Gpt_00292] [

Service name:	Gpt_Notification_<channel>
Syntax:	void Gpt_Notification_<channel>(void)
Sync/Async:	Synchronous
Reentrancy:	GPT user implementation dependant.
Parameters (in):	None
Parameters (inout):	None
Parameters (out):	None
Return value:	None
Description:	--

] (SRS_BSW_00375, SRS_SPAL_12069)

The notification prototype `Gpt_Notification_<channel>` is for the notification callback function and shall be implemented by the user.

The GPT module's environment shall declare a separate notification for each channel to avoid parameters in notification services and to improve run time efficiency.

[SWS_Gpt_00086] [The callback notifications `Gpt_Notification_<channel>` shall be configurable as pointers to user defined functions within the configuration structure.] ()

[SWS_Gpt_00209] [Each channel shall provide its own notification if configured.] (SRS_BSW_00375, SRS_SPAL_12069)

[SWS_Gpt_00093] [When disabled, the GPT Driver will send no notification.] ()

[SWS_Gpt_00233] [The GPT Driver shall invoke a notification whenever the defined target time of the channel is reached.] (SRS_SPAL_12067, SRS_Gpt_12120)

[SWS_Gpt_00206] [The ISR's, providing the timer events, shall be responsible for resetting the interrupt flags (if needed by hardware) and calling the according notification function.] (SRS_SPAL_12129)

[SWS_Gpt_00362] [For all available channels, callback functions have to be declared by the configuration tool.] ()

9 Sequence diagrams

All functions except `Gpt_Init`, `Gpt_DeInit`, `Gpt_GetVersionInfo` and `Gpt_SetMode` are synchronous and re-entrant.

9.1 Gpt_Init

The ECU State Manager (EcuM) is responsible for calling the init function.

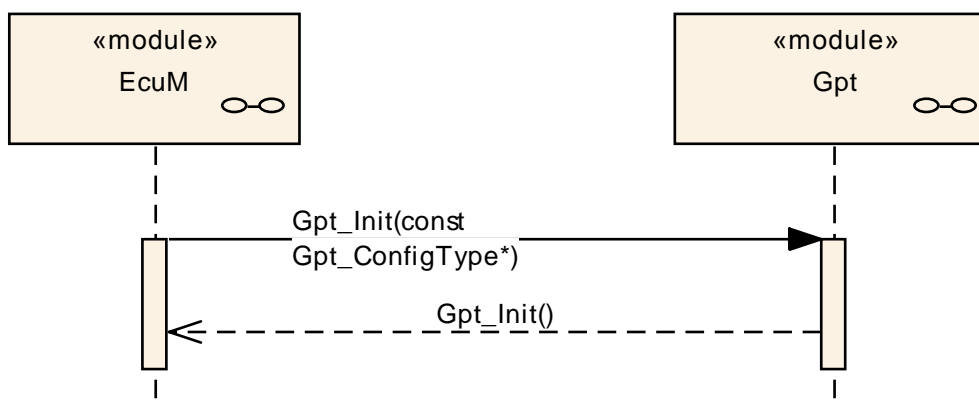

Figure 7: Sequence Diagram - Gpt_Init

9.2 GPT continuous mode

Channel 2 is configured as “Continuous Mode”

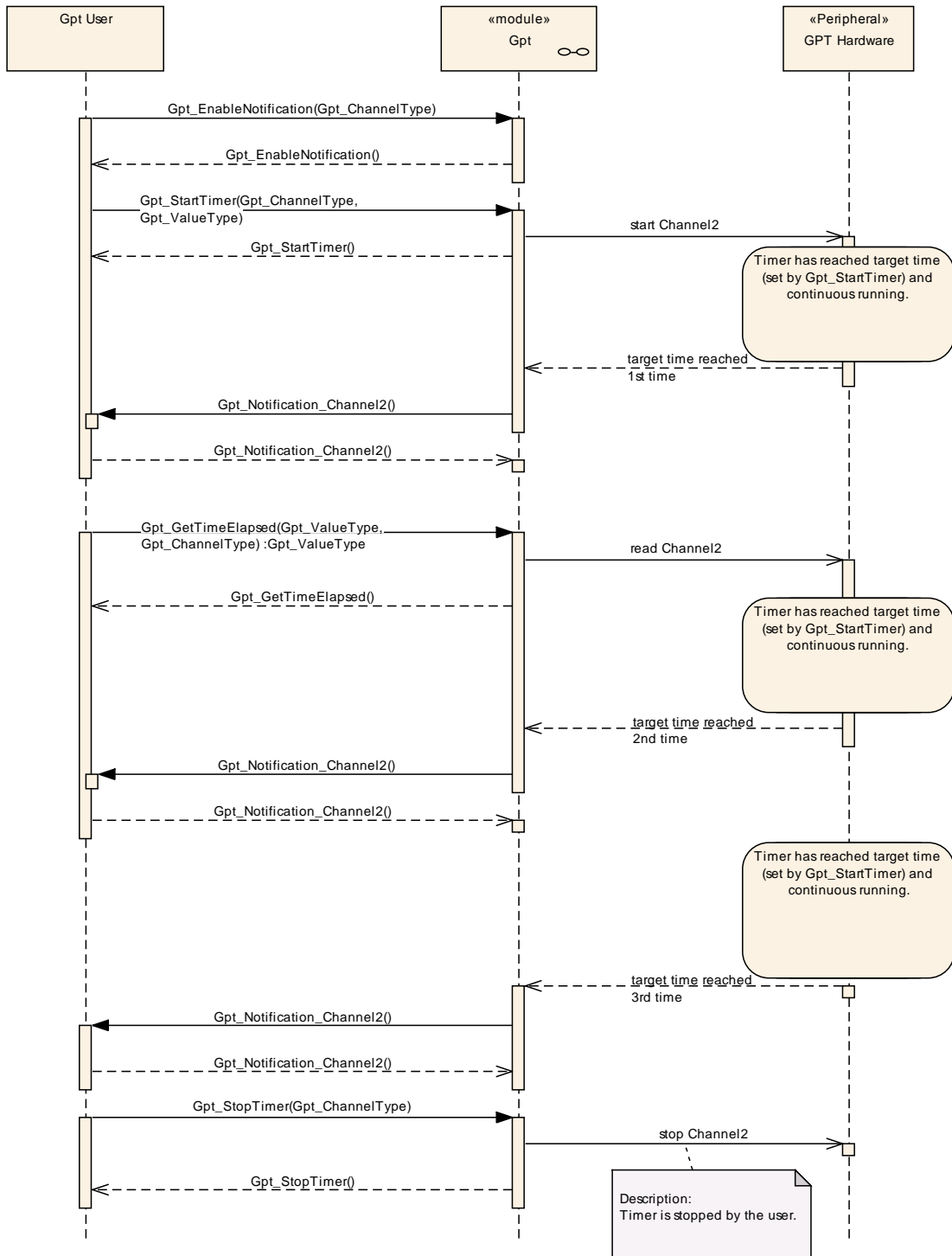

Figure 8: Sequence Diagram - GPT continuous mode

9.3 GPT one-shot mode

Channel 1 is configured for “One-shot Mode”

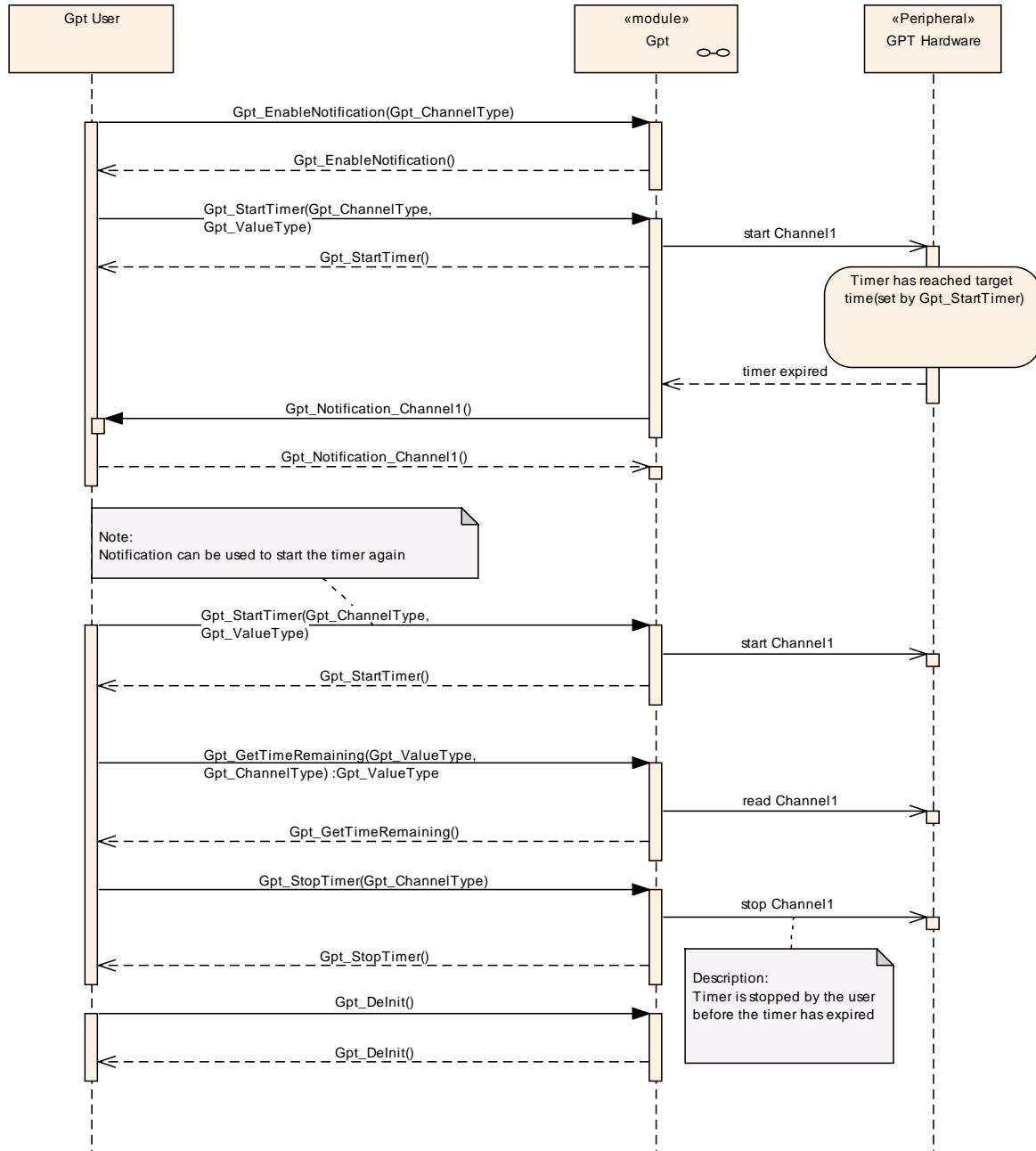

Figure 9: Sequence Diagram - GPT one-shot mode

9.4 Disable/Enable Notifications

The sequence diagram shown in this chapter explains the behavior of the driver, when the notification is disabled, while the timer is still running in continuous mode. If the notification is disabled, the user will not be informed, when the timer reaches the target time the 2nd time (period 2).

This notification is discarded and not made up again, when the notification is re-enabled.

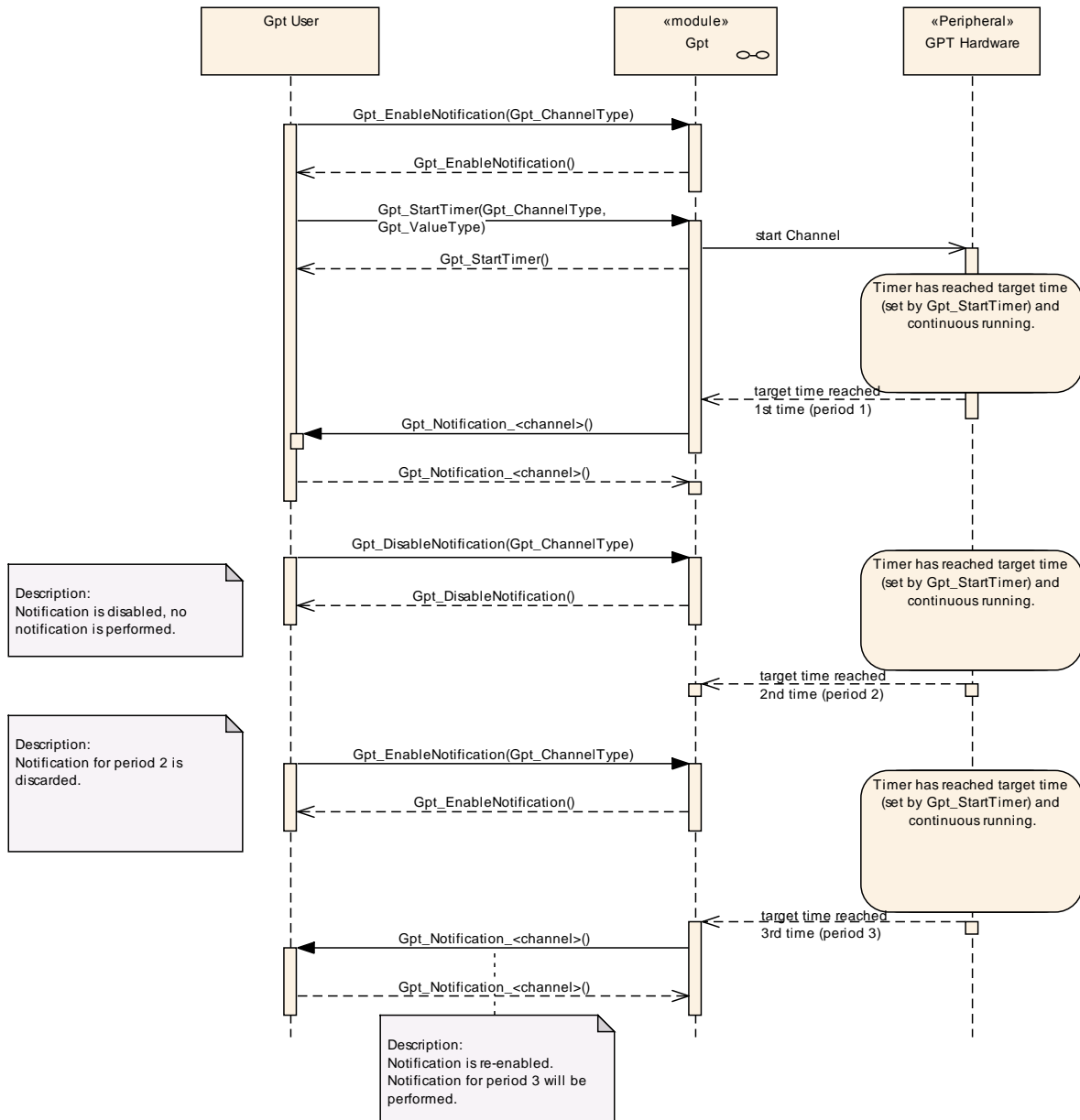

Figure 10: Sequence Diagram - Disable/Enable Notifications

9.5 Wakeup

Note: Sequence charts on timer wakeup can be found in the ECU state manager specification [8].

10 Configuration specification

In general, this chapter defines configuration parameters and their clustering into containers. In order to support the specification Chapter 10.1 describes fundamentals. It also specifies a template (table) you shall use for the parameter specification. We intend to leave Chapter 10.1 in the specification to guarantee comprehension.

Chapter 10.2 specifies the structure (containers) and the parameters of the module GPT

Chapter 10.3 specifies published information of the module GPT

10.1 How to read this chapter

For details refer to the chapter 10.1 “Introduction to configuration specification” in *SWS_BSWGeneral*.

10.2 Containers and configuration parameters

The following chapters summarize all configuration parameters. The detailed meanings of the parameters describe Chapter 7 and Chapter 8.

10.2.1 Variants

Configuration variants describe sets of configuration parameters:

- VARIANT-PRE-COMPILE (PC)
Only parameters with "Pre-compile time" configuration are allowed in this variant.
- VARIANT-LINK-TIME (LT)
Only parameters with "Pre-compile time" and "Link time" are allowed in this variant.
- VARIANT-POST-BUILD (PB)
Parameters with "Pre-compile time", "Link time" and "Post-build time" are allowed in this variant.

[SWS_Gpt_00342] | At least one of the following variants has to be supported by implementation:

- VARIANT-PRE-COMPILE
- VARIANT-POST-BUILD

| (SRS_BSW_00397, SRS_BSW_00399, SRS_BSW_00400)

[SWS_Gpt_00257] | The initialization function of this module shall always have a pointer as a parameter. For variant "Pre-compile time" (no pointer to configuration is available) a null pointer shall be passed. | (SRS_BSW_00414)

[SWS_Gpt_00270] | Within one container it shall not be possible to mix parameters assigned to different configuration classes. | ()

10.2.2 Gpt

Module Name	Gpt
Module Description	Configuration of the Gpt (General Purpose Timer) module.
Post-Build Variant Support	true

Included Containers		
Container Name	Multiplicity	Scope / Dependency
GptChannelConfigSet	1	This container is the base of a Configuration Set which contains the configured GPT channels. This way, different configuration sets can be defined for post-build process.
GptConfigurationOfOptApiServices	1	This container contains all configuration switches for configuring optional API services of the GPT driver.
GptDriverConfiguration	1	This container contains the module-wide configuration (parameters) of the GPT Driver

10.2.3 GptDriverConfiguration

SWS Item	ECUC_Gpt_00183 :		
Container Name	GptDriverConfiguration		
Description	This container contains the module-wide configuration (parameters) of the GPT Driver		
Configuration Parameters			

SWS Item	ECUC_Gpt_00321 :		
Name	GptDevErrorDetect		
Description	Switches the Default Error Tracer (Det) detection and notification ON or OFF. <ul style="list-style-type: none"> true: enabled (ON). false: disabled (OFF). 		
Multiplicity	1		
Type	EcucBooleanParamDef		
Default value	--		
Post-Build Variant Value	false		
Value Configuration Class	Pre-compile time	X	All Variants
	Link time	--	
	Post-build time	--	
Scope / Dependency	scope: local		

SWS Item	ECUC_Gpt_00335 :		
Name	GptPredefTimer100us32bitEnable		
Description	Enables/disables the GPT Predef Timer 100µs32bit.		
Multiplicity	1		
Type	EcucBooleanParamDef		
Default value	--		
Post-Build Variant Value	false		
Value Configuration Class	Pre-compile time	X	All Variants
	Link time	--	

	Post-build time	--	
Scope / Dependency	scope: ECU		

SWS Item	ECUC_Gpt_00334 :		
Name	GptPredefTimer1usEnablingGrade		
Description	Specifies the grade of enabling the GPT Predef Timers with 1µs tick duration.		
Multiplicity	1		
Type	EcucEnumerationParamDef		
Range	GPT_PREDEF_TIMER_1US_16BIT_ENABLED	16bit timer enabled	
	GPT_PREDEF_TIMER_1US_16_24BIT_ENABLED	16 and 24bit timers enabled	
	GPT_PREDEF_TIMER_1US_16_24_32BIT_ENABLED	16, 24 and 32bit timers enabled	
	GPT_PREDEF_TIMER_1US_DISABLED	disabled	
Post-Build Variant Value	false		
Value Configuration Class	Pre-compile time	X	All Variants
	Link time	--	
	Post-build time	--	
Scope Dependency	scope: ECU		

SWS Item	ECUC_Gpt_00322 :		
Name	GptReportWakeupSource		
Description	Enables/Disables wakeup source reporting.		
Multiplicity	1		
Type	EcucBooleanParamDef		
Default value	--		
Post-Build Variant Value	false		
Value Configuration Class	Pre-compile time	X	All Variants
	Link time	--	
	Post-build time	--	
Scope / Dependency	scope: local		

Included Containers		
Container Name	Multiplicity	Scope / Dependency
GptClockReferencePoint	1..*	This container contains a parameter, which represents a reference to a container of the type McuClockReferencePoint (defined in module MCU).

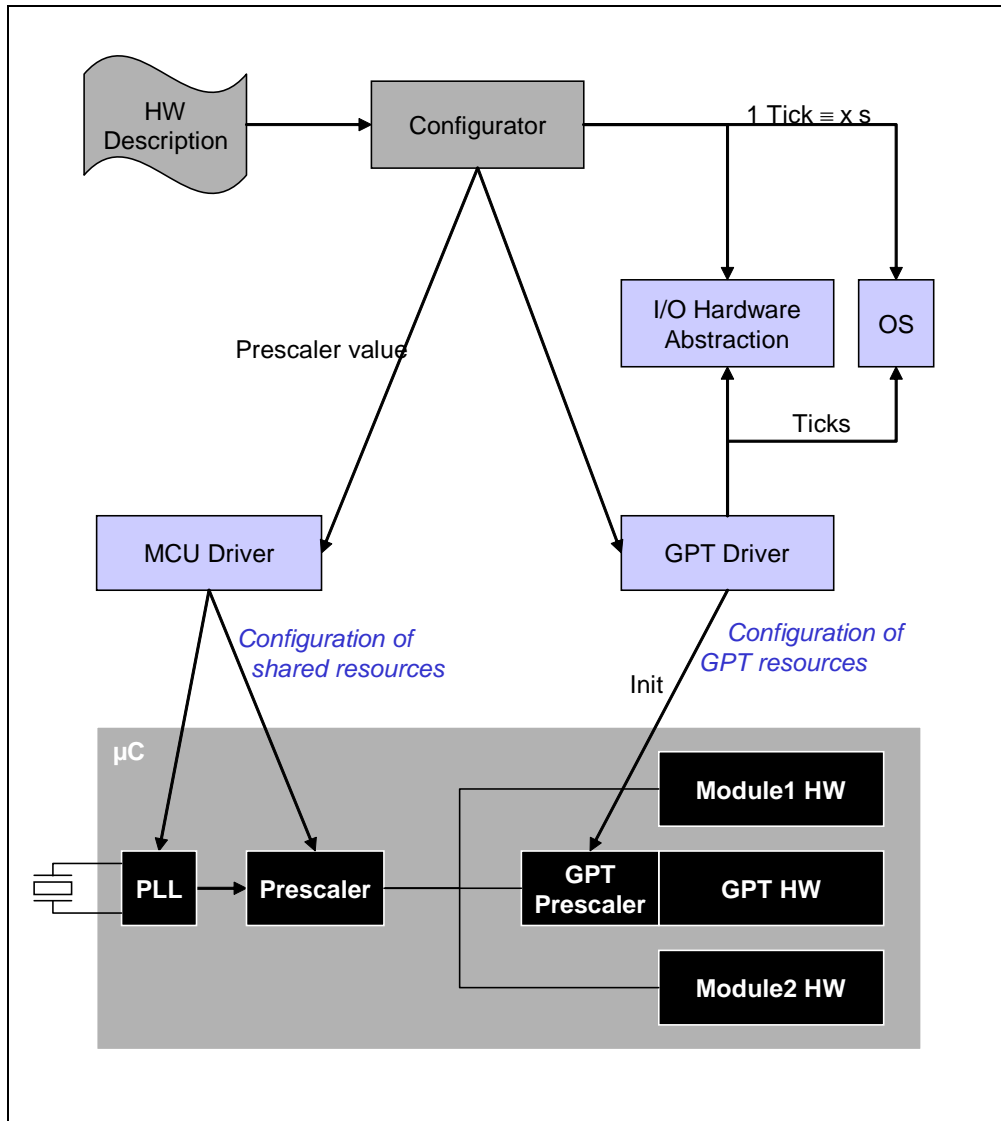

Figure 11: Scope of the GPT Driver configuration

10.2.4 GptClockReferencePoint

SWS Item	ECUC_Gpt_00329 :
Container Name	GptClockReferencePoint
Description	This container contains a parameter, which represents a reference to a container of the type McuClockReferencePoint (defined in module MCU). A container is needed to support multiple clock references (hardware dependent).
Configuration Parameters	

SWS Item	ECUC_Gpt_00330 :
Name	GptClockReference
Description	Reference to a container of the type McuClockReferencePoint, to select an input clock. The configuration editor for the GPT module can support the integrator by only allowing a selection of those clock reference points that can be connected physically to the GPT hardware peripheral. The desired

	frequency (desired by GPT) has to be the same as the selected and provided frequency of the MCU configuration. This has to be checked automatically.		
Multiplicity	1		
Type	Reference to [McuClockReferencePoint]		
Post-Build Variant Value	false		
Value Configuration Class	Pre-compile time	X	All Variants
	Link time	--	
	Post-build time	--	
Scope / Dependency	scope: local		

No Included Containers

10.2.5 GptChannelConfigSet

SWS Item	ECUC_Gpt_00269 :		
Container Name	GptChannelConfigSet		
Description	This container is the base of a Configuration Set which contains the configured GPT channels. This way, different configuration sets can be defined for post-build process.		
Configuration Parameters			

Included Containers			
Container Name	Multiplicity	Scope / Dependency	
GptChannelConfiguration	1..*	This container contains the channel specific configuration of the GPT Driver.	

10.2.6 GptChannelConfiguration

SWS Item	ECUC_Gpt_00184 :		
Container Name	GptChannelConfiguration		
Description	Configuration of an individual GPT channel.		
Configuration Parameters			

SWS Item	ECUC_Gpt_00308 :		
Name	GptChannelId		
Description	Channel Id of the GPT channel. This value will be assigned to the symbolic name derived of the GptChannelConfiguration container short name.		
Multiplicity	1		
Type	EcuIntegerParamDef (Symbolic Name generated for this parameter)		
Range	0 .. 4294967295		
Default value	--		
Post-Build Variant Value	false		
Value Configuration Class	Pre-compile time	X	All Variants
	Link time	--	
	Post-build time	--	
Scope / Dependency	scope: ECU		

SWS Item	ECUC_Gpt_00309 :		
Name	GptChannelMode		

Description	Specifies the behavior of the timer channel after the target time is reached.		
Multiplicity	1		
Type	EcucEnumerationParamDef		
Range	GPT_CH_MODE_CONTINUOUS	After reaching the target time, the timer continues running with the value "zero" again.	
	GPT_CH_MODE_ONESHOT	After reaching the target time, the timer stops automatically (timer expired).	
Post-Build Variant Value	true		
Value Configuration Class	Pre-compile time	X	VARIANT-PRE-COMPILE
	Link time	--	
	Post-build time	X	VARIANT-POST-BUILD
Scope Dependency	scope: ECU		

SWS Item	ECUC_Gpt_00331 :		
Name	GptChannelTickFrequency		
Description	Specifies the tick frequency of the timer channel in Hz.		
Multiplicity	1		
Type	EcucFloatParamDef		
Range	0 .. INF		
Default value	--		
Post-Build Variant Value	true		
Value Configuration Class	Pre-compile time	X	VARIANT-PRE-COMPILE
	Link time	--	
	Post-build time	X	VARIANT-POST-BUILD
Scope / Dependency	scope: ECU		

SWS Item	ECUC_Gpt_00332 :		
Name	GptChannelTickValueMax		
Description	Maximum value in ticks, the timer channel is able to count. With the next tick, the timer rolls over to zero.		
Multiplicity	1		
Type	EcucIntegerParamDef		
Range	0 .. 18446744073709551615		
Default value	--		
Post-Build Variant Value	true		
Value Configuration Class	Pre-compile time	X	VARIANT-PRE-COMPILE
	Link time	--	
	Post-build time	X	VARIANT-POST-BUILD
Scope / Dependency	scope: ECU		

SWS Item	ECUC_Gpt_00311 :		
Name	GptEnableWakeup		
Description	Enables wakeup capability of MCU for a channel.		
Multiplicity	1		
Type	EcucBooleanParamDef		
Default value	--		
Post-Build Variant Value	true		
Value Configuration Class	Pre-compile time	X	VARIANT-PRE-COMPILE
	Link time	--	
	Post-build time	X	VARIANT-POST-BUILD
Scope / Dependency	scope: local		

SWS Item	ECUC_Gpt_00312 :		
Name	GptNotification		
Description	Function pointer to callback function (for non-wakeup notification)		
Multiplicity	0..1		
Type	EcucFunctionNameDef		
Default value	--		
maxLength	--		
minLength	--		
regularExpression	--		
Post-Build Variant Multiplicity	true		
Post-Build Variant Value	true		
Multiplicity Configuration Class	Pre-compile time	X	VARIANT-PRE-COMPILE
	Link time	--	
	Post-build time	X	VARIANT-POST-BUILD
Value Configuration Class	Pre-compile time	X	VARIANT-PRE-COMPILE
	Link time	--	
	Post-build time	X	VARIANT-POST-BUILD
Scope / Dependency	scope: local		

SWS Item	ECUC_Gpt_00333 :		
Name	GptChannelClkSrcRef		
Description	Reference to the GptClockReferencePoint from which the channel clock is derived.		
Multiplicity	1		
Type	Reference to [GptClockReferencePoint]		
Post-Build Variant Value	true		
Value Configuration Class	Pre-compile time	X	VARIANT-PRE-COMPILE
	Link time	--	
	Post-build time	X	VARIANT-POST-BUILD
Scope / Dependency	scope: local		

Included Containers		
Container Name	Multiplicity	Scope / Dependency
GptWakeupConfiguration	0..1	Function pointer to callback function (for non-wakeup notification).

10.2.7 GptWakeupConfiguration

SWS Item	ECUC_Gpt_00235 :		
Container Name	GptWakeupConfiguration		
Description	Function pointer to callback function (for wakeup notification).		
Configuration Parameters			

SWS Item	ECUC_Gpt_00313 :		
Name	GptWakeupSourceRef		
Description	In case the wakeup-capability is true this value is transmitted to the Ecu State Manager. Implementation Type: reference to EcuM_WakeupSourceType		
Multiplicity	1		
Type	Symbolic name reference to [EcuMWakeupSource]		
Post-Build Variant Value	true		

Value Configuration Class	Pre-compile time	X	VARIANT-PRE-COMPILE
	Link time	--	
	Post-build time	X	VARIANT-POST-BUILD
Scope / Dependency	scope: local		

No Included Containers

10.2.8 GptConfigurationOfOptApiServices

SWS Item	ECUC_Gpt_00193 :		
Container Name	GptConfigurationOfOptApiServices		
Description	This container contains all configuration switches for configuring optional API services of the GPT driver.		
Configuration Parameters			

SWS Item	ECUC_Gpt_00314 :		
Name	GptDeinitApi		
Description	Adds / removes the service Gpt_DeInit() from the code.		
Multiplicity	1		
Type	EcucBooleanParamDef		
Default value	--		
Post-Build Variant Value	false		
Value Configuration Class	Pre-compile time	X	All Variants
	Link time	--	
	Post-build time	--	
Scope / Dependency	scope: local		

SWS Item	ECUC_Gpt_00315 :		
Name	GptEnableDisableNotificationApi		
Description	Adds / removes the services Gpt_EnableNotification() and Gpt_DisableNotification from the code.		
Multiplicity	1		
Type	EcucBooleanParamDef		
Default value	--		
Post-Build Variant Value	false		
Value Configuration Class	Pre-compile time	X	All Variants
	Link time	--	
	Post-build time	--	
Scope / Dependency	scope: local		

SWS Item	ECUC_Gpt_00317 :		
Name	GptTimeElapsedApi		
Description	Adds / removes the service Gpt_GetTimeElapsed() from the code		
Multiplicity	1		
Type	EcucBooleanParamDef		
Default value	--		
Post-Build Variant Value	false		
Value Configuration Class	Pre-compile time	X	All Variants
	Link time	--	
	Post-build time	--	
Scope / Dependency	scope: local		

SWS Item	ECUC_Gpt_00318 :		
-----------------	-------------------------	--	--

Name	GptTimeRemainingApi		
Description	Adds / removes the service Gpt_GetTimeRemaining() from the code.		
Multiplicity	1		
Type	EcucBooleanParamDef		
Default value	--		
Post-Build Variant Value	false		
Value Configuration Class	Pre-compile time	X	All Variants
	Link time	--	
	Post-build time	--	
Scope / Dependency	scope: local		

SWS Item	ECUC_Gpt_00319 :		
Name	GptVersionInfoApi		
Description	Adds / removes the service Gpt_GetVersionInfo() from the code.		
Multiplicity	1		
Type	EcucBooleanParamDef		
Default value	--		
Post-Build Variant Value	false		
Value Configuration Class	Pre-compile time	X	All Variants
	Link time	--	
	Post-build time	--	
Scope / Dependency	scope: local		

SWS Item	ECUC_Gpt_00320 :		
Name	GptWakeupFunctionalityApi		
Description	Adds / removes the services Gpt_SetMode(), Gpt_EnableWakeup() Gpt_DisableWakeup() and Gpt_CheckWakeup() from the code.		
Multiplicity	1		
Type	EcucBooleanParamDef		
Default value	--		
Post-Build Variant Value	false		
Value Configuration Class	Pre-compile time	X	All Variants
	Link time	--	
	Post-build time	--	
Scope / Dependency	scope: local		

No Included Containers

10.3 Published Information

[SWS_Gpt_00380] | The standardized common published parameters as required by SRS_BSW_00402 in the SRS General on Basic Software Modules [3] shall be published within the header file of this module and need to be provided in the BSW Module Description. The according module abbreviation can be found in the List of Basic Software Modules [1]. | ()

Additional module-specific published parameters are listed below if applicable.

11 Not applicable requirements

[SWS_Gpt_00381] [These requirements are not applicable to this specification.]
(SRS_BSW_00344, SRS_BSW_00159, SRS_BSW_00167, SRS_BSW_00170,
SRS_BSW_00398, SRS_BSW_00416, SRS_BSW_00437, SRS_BSW_00168,
SRS_BSW_00423, SRS_BSW_00424, SRS_BSW_00425, SRS_BSW_00426,
SRS_BSW_00427, SRS_BSW_00428, SRS_BSW_00429, SRS_BSW_00432,
SRS_BSW_00433, SRS_BSW_00422, SRS_BSW_00417, SRS_BSW_00161,
SRS_BSW_00162, SRS_BSW_00005, SRS_BSW_00415, SRS_BSW_00325,
SRS_BSW_00342, SRS_BSW_00160, SRS_BSW_00007, SRS_BSW_00413,
SRS_BSW_00347, SRS_BSW_00307, SRS_BSW_00373, SRS_BSW_00335,
SRS_BSW_00348, SRS_BSW_00353, SRS_BSW_00361, SRS_BSW_00328,
SRS_BSW_00006, SRS_BSW_00439, SRS_BSW_00357, SRS_BSW_00377,
SRS_BSW_00378, SRS_BSW_00306, SRS_BSW_00308, SRS_BSW_00309,
SRS_BSW_00359, SRS_BSW_00360, SRS_BSW_00440, SRS_BSW_00330,
SRS_BSW_00331, SRS_BSW_00009, SRS_BSW_00172, SRS_BSW_00010,
SRS_BSW_00333, SRS_BSW_00321, SRS_BSW_00341, SRS_BSW_00334,
SRS_SPAL_12462, SRS_SPAL_12463, SRS_SPAL_12068, SRS_SPAL_12075,
SRS_SPAL_12064, SRS_SPAL_12077, SRS_SPAL_12078, SRS_SPAL_12092,
SRS_SPAL_12265)