

<b>Document Title</b>	Specification of NVRAM Manager
<b>Document Owner</b>	AUTOSAR
<b>Document Responsibility</b>	AUTOSAR
<b>Document Identification No</b>	033
<b>Document Classification</b>	Standard

<b>Document Version</b>	2.3.0
<b>Document Status</b>	Final
<b>Part of Release</b>	3.1
<b>Revision</b>	5

<b>Document Change History</b>			
<b>Date</b>	<b>Version</b>	<b>Changed by</b>	<b>Change Description</b>
10.09.2010	2.3.0	AUTOSAR Administration	<ul style="list-style-type: none"> <li>• Behavior specified to prevent possible loss of data during shutdown</li> <li>• Typo corrected in chapter 7.1.2.1</li> <li>• Behavior specified: handling of single-block callbacks during asynchronous multi-block requests</li> <li>• Behavior specified when NVRAM block ID 1 shall be written</li> <li>• Include of Crc.h is not optional</li> <li>• Legal disclaimer revised</li> </ul>
23.06.2008	2.2.1	AUTOSAR Administration	Legal disclaimer revised
11.12.2007	2.2.0	AUTOSAR Administration	<ul style="list-style-type: none"> <li>• Technical Office SWS Improvements are incorporated.</li> <li>• Requirement IDs for configuration parameters (chapter 10) added.</li> <li>• Management of the RAM block state specified more precisely.</li> <li>• The NVRAM Manager doesn't support non-sequential NVRAM block IDs any longer.</li> <li>• Document meta information extended</li> <li>• Small layout adaptations made</li> </ul>

26.01.2007	2.1.0	AUTOSAR Administration	<ul style="list-style-type: none"><li>• AUTOSAR service description added in chapter 13</li><li>• Reentrancy of callback functions specified</li><li>• Details regarding memory hardware abstraction addressing scheme added</li><li>• Further changes see chapter 11</li> <li>• Legal disclaimer revised</li><li>• “Advice for users” revised</li><li>• “Revision Information” added</li></ul>
28.04.2006	2.0.0	AUTOSAR Administration	Document structure adapted to common Release 2.0 SWS Template. <ul style="list-style-type: none"><li>• Major changes in chapter10</li><li>• Structure of document changed partly</li><li>• Other changes see chapter 11</li></ul>
20.06.2005	1.0.0	AUTOSAR Administration	Initial release

## **Disclaimer**

This specification and the material contained in it, as released by AUTOSAR is for the purpose of information only. AUTOSAR and the companies that have contributed to it shall not be liable for any use of the specification.

The material contained in this specification is protected by copyright and other types of Intellectual Property Rights. The commercial exploitation of the material contained in this specification requires a license to such Intellectual Property Rights.

This specification may be utilized or reproduced without any modification, in any form or by any means, for informational purposes only.

For any other purpose, no part of the specification may be utilized or reproduced, in any form or by any means, without permission in writing from the publisher.

The AUTOSAR specifications have been developed for automotive applications only. They have neither been developed, nor tested for non-automotive applications.

The word AUTOSAR and the AUTOSAR logo are registered trademarks.

## **Advice for users**

AUTOSAR Specification Documents may contain exemplary items (exemplary reference models, "use cases", and/or references to exemplary technical solutions, devices, processes or software).

Any such exemplary items are contained in the Specification Documents for illustration purposes only, and they themselves are not part of the AUTOSAR Standard. Neither their presence in such Specification Documents, nor any later documentation of AUTOSAR conformance of products actually implementing such exemplary items, imply that intellectual property rights covering such exemplary items are licensed under the same rules as applicable to the AUTOSAR Standard.

## Table of Contents

1	Introduction and functional overview .....	8
2	Acronyms and abbreviations .....	9
3	Related documentation.....	11
3.1	Input documents.....	11
4	Constraints and assumptions .....	12
4.1	Limitations .....	12
4.2	Applicability to car domains.....	12
4.3	Conflicts .....	12
5	Dependencies to other modules.....	13
5.1	File structure .....	13
5.1.1	Code file structure .....	13
5.1.2	Header file structure.....	13
5.2	Memory abstraction modules .....	13
5.3	CRC module.....	14
5.4	Capability of the underlying drivers .....	14
6	Requirements traceability .....	15
7	Functional specification .....	21
7.1	Basic architecture guidelines.....	21
7.1.1	Layer structure .....	21
7.1.2	Addressing scheme for the memory hardware abstraction .....	21
7.1.2.1	Examples of addressing scheme for the memory hardware abstraction	22
7.1.3	Basic storage objects .....	23
7.1.3.1	NV block.....	23
7.1.3.2	RAM block.....	23
7.1.3.3	ROM block .....	24
7.1.3.4	Administrative block .....	25
7.1.4	Block management types .....	26
7.1.4.1	Block management types overview.....	26
7.1.4.2	NVRAM block structure.....	26
7.1.4.3	NVRAM block descriptor table .....	26
7.1.4.4	Native NVRAM block .....	26
7.1.4.5	Redundant NVRAM block .....	27
7.1.4.6	Dataset NVRAM block .....	27
7.1.4.7	NVRAM Manager API configuration classes.....	29
7.1.5	Scan order / priority scheme .....	30
7.2	General behavior.....	31
7.2.1	Functional requirements.....	31
7.2.2	Design notes .....	32
7.2.2.1	NVRAM manager startup .....	32

7.2.2.2	NVRAM manager shutdown.....	33
7.2.2.3	(Quasi) parallel write access to the NvM module .....	34
7.2.2.4	Avoid infinite loops .....	34
7.2.2.5	NVRAM block consistency check.....	34
7.2.2.6	Error recovery .....	34
7.2.2.7	Recovery of a RAM block with ROM data .....	34
7.2.2.8	Implicit recovery of a RAM block with ROM default data.....	35
7.2.2.9	Explicit recovery of a RAM block with ROM default data .....	35
7.2.2.10	Detection of an incomplete write operation to a NV block .....	36
7.2.2.11	Termination of a single block request .....	36
7.2.2.12	Termination of a multi block request .....	36
7.2.2.13	General handling of asynchronous requests/ job processing.....	36
7.2.2.14	NVRAM block write protection .....	37
7.2.2.15	Validation and modification of RAM block data .....	38
7.2.2.16	Communication and synchronization between application and NVRAM manager.....	40
7.2.2.17	Normal and extended runtime preparation of NVRAM blocks.....	43
7.3	Error classification .....	43
7.4	Error detection.....	44
7.5	Error notification .....	46
7.6	Version check.....	46
8	API specification.....	47
8.1	Imported types.....	47
8.2	Type definitions .....	47
8.2.1	NvM_RequestResultType .....	47
8.2.2	NvM_BlockIdType .....	48
8.3	Function definitions .....	49
8.3.1	Synchronous requests .....	49
8.3.1.1	NvM_Init.....	49
8.3.1.2	NvM_SetDataIndex.....	49
8.3.1.3	NvM_GetDataIndex .....	51
8.3.1.4	NvM_SetBlockProtection .....	51
8.3.1.5	NvM_GetErrorStatus.....	52
8.3.1.6	NvM_GetVersionInfo.....	53
8.3.1.7	NvM_SetRamBlockStatus.....	54
8.3.2	Asynchronous single block requests .....	55
8.3.2.1	NvM_ReadBlock .....	55
8.3.2.2	NvM_WriteBlock .....	58
8.3.2.3	NvM_RestoreBlockDefaults .....	60
8.3.2.4	NvM_EraseNvBlock .....	62
8.3.2.5	NvM_CancelWriteAll .....	63
8.3.2.6	NvM_InvalidateNvBlock .....	64
8.3.3	Asynchronous multi block requests.....	66
8.3.3.1	NvM_ReadAll .....	66
8.3.3.2	NvM_WriteAll .....	72
8.4	Call-back notifications .....	74
8.4.1	Callback notification of the NvM module .....	74
8.4.1.1	NVRAM Manager job end notification without error .....	74

8.4.1.2	NVRAM Manager job end notification with error .....	75
8.5	Scheduled functions .....	76
8.6	Expected Interfaces .....	77
8.6.1	Mandatory Interfaces .....	78
8.6.2	Optional Interfaces .....	78
8.6.3	Configurable interfaces .....	78
8.6.3.1	Single block job end notification .....	79
8.6.3.2	Multi block job end notification .....	80
8.6.3.3	Callback function for block initialization .....	80
8.7	API Overview .....	81
9	Sequence Diagrams .....	82
9.1	Synchronous calls .....	82
9.1.1	NvM_Init .....	82
9.1.2	NvM_SetDataIndex .....	82
9.1.3	NvM_GetDataIndex .....	83
9.1.4	NvM_SetBlockProtection .....	83
9.1.5	NvM_GetErrorStatus .....	84
9.1.6	NvM_GetVersionInfo .....	84
9.2	Asynchronous calls .....	84
9.2.1	Asynchronous call with polling .....	85
9.2.2	Asynchronous call with callback .....	85
9.2.3	Cancellation of a Multi Block Request .....	87
10	Configuration specification .....	88
10.1	How to read this chapter .....	88
10.1.1	Configuration and configuration parameters .....	88
10.1.2	Variants .....	88
10.1.3	Containers .....	88
10.2	Containers and configuration parameters .....	89
10.2.1	Variants .....	89
10.2.2	NvM .....	89
10.2.3	NvmCommon .....	89
10.2.4	NvmBlockDescriptor .....	94
10.2.5	NvmTargetBlockReference .....	99
10.2.6	NvmEaRef .....	100
10.2.7	NvmFeeRef .....	100
10.3	Common configuration options .....	101
10.3.1	Published parameters .....	101
11	Changes to Release 1 .....	103
11.1	Deleted SWS Items .....	103
11.2	Replaced SWS Items .....	104
11.3	Changed SWS Items .....	104
11.4	Added SWS Items .....	104
12	Changes during SWS Improvements .....	106
12.1	Deleted SWS Items .....	106
12.2	Replaced SWS Items .....	106
12.3	Changed SWS Items .....	107

12.4	Added SWS Items .....	107
13	AUTOSAR Service implemented by the NVRAM Manger .....	109
13.1	Scope of this Chapter .....	109
13.1.1	Package .....	109
13.2	Overview .....	109
13.2.1	Architecture .....	109
13.2.2	Requirements .....	110
13.2.3	Use Cases .....	111
13.2.3.1	Implicit Update and Restore of RAM Mirror .....	111
13.2.3.2	Explicit Update and Restore of RAM Mirror .....	112
13.2.3.3	Explicit Update and Restore via a Local Buffer .....	113
13.3	Specification of the Ports and Port Interfaces .....	114
13.3.1	Ports and Port Interface for Single Block Requests .....	114
13.3.1.1	General Approach .....	114
13.3.1.2	Data Types .....	115
13.3.1.3	Port Interface .....	116
13.3.1.4	Ports .....	117
13.3.2	Ports and Port Interface for Notifications .....	118
13.3.3	Ports and Port Interfaces for Administrative Operations .....	119
13.3.4	Summary of all Ports .....	120
13.4	Access to the Memory Blocks .....	121
13.5	InternalBehavior .....	122
13.6	Configuration of the Block IDs .....	123

## 1 Introduction and functional overview

This specification describes the functionality, API and the configuration of the AUTOSAR Basic Software module NVRAM Manager.

The NvM module shall provide services to ensure the data storage and maintenance of NV data according to their individual requirements in an automotive environment. The NvM module shall be able to administrate the NV data of an EEPROM and/or a FLASH EEPROM emulation device.

The NvM module shall provide the required synchronous/asynchronous services for the management and the maintenance of NV data (init/read/write/control).



## 2 Acronyms and abbreviations

Acronyms and abbreviations, which have a local scope and therefore are not contained in the AUTOSAR glossary, must appear in a local glossary.

<b>Abbreviation/ Acronym:</b>	<b>Description:</b>
Basic Storage Object	A "Basic Storage Object" is the smallest entity of a "NVRAM block". Several "Basic Storage Objects" can be used to build a NVRAM Block. A "Basic Storage Object" can reside in different memory locations (RAM/ROM/NV memory).
NVRAM Block	The "NVRAM Block" is the entire structure, which is needed to administrate and to store a block of NV data.
NV data	The data to be stored in Non-Volatile memory.
Block Management Type	Type of the NVRAM Block. It depends on the (configurable) individual composition of a NVRAM Block in chunks of different mandatory/optional Basic Storage Objects and the subsequent handling of this NVRAM block.
RAM Block	The „RAM Block“ is a „Basic Storage Object“. It represents the part of a „NVRAM Block“ which resides in the RAM. See [BSW08534] .[NVM126]
ROM Block	The „ROM Block“ is a „Basic Storage Object“. It represents the part of a „NVRAM Block“ which resides in the ROM. The „ROM Block“ is an optional part of a „NVRAM Block“. [NVM020]
NV Block	The „NV Block“ is a „Basic Storage Object“. It represents the part of a „NVRAM Block“ which resides in the NV memory. The „NV Block“ is a mandatory part of a „NVRAM Block“. [NVM125]
Administrative Block	The "Administrative Block" is a "Basic Storage Object". It resides in RAM. The "Administrative Block" is a mandatory part of a "NVRAM Block". [NVM135]
DET	Development Error Tracer – module to which development errors are reported.
DEM	Diagnostic Event Manager – module to which production relevant errors are reported
NV	Non volatile
FEE	Flash EEPROM Emulation
EA	EEPROM Abstraction
FCFS	First come first served

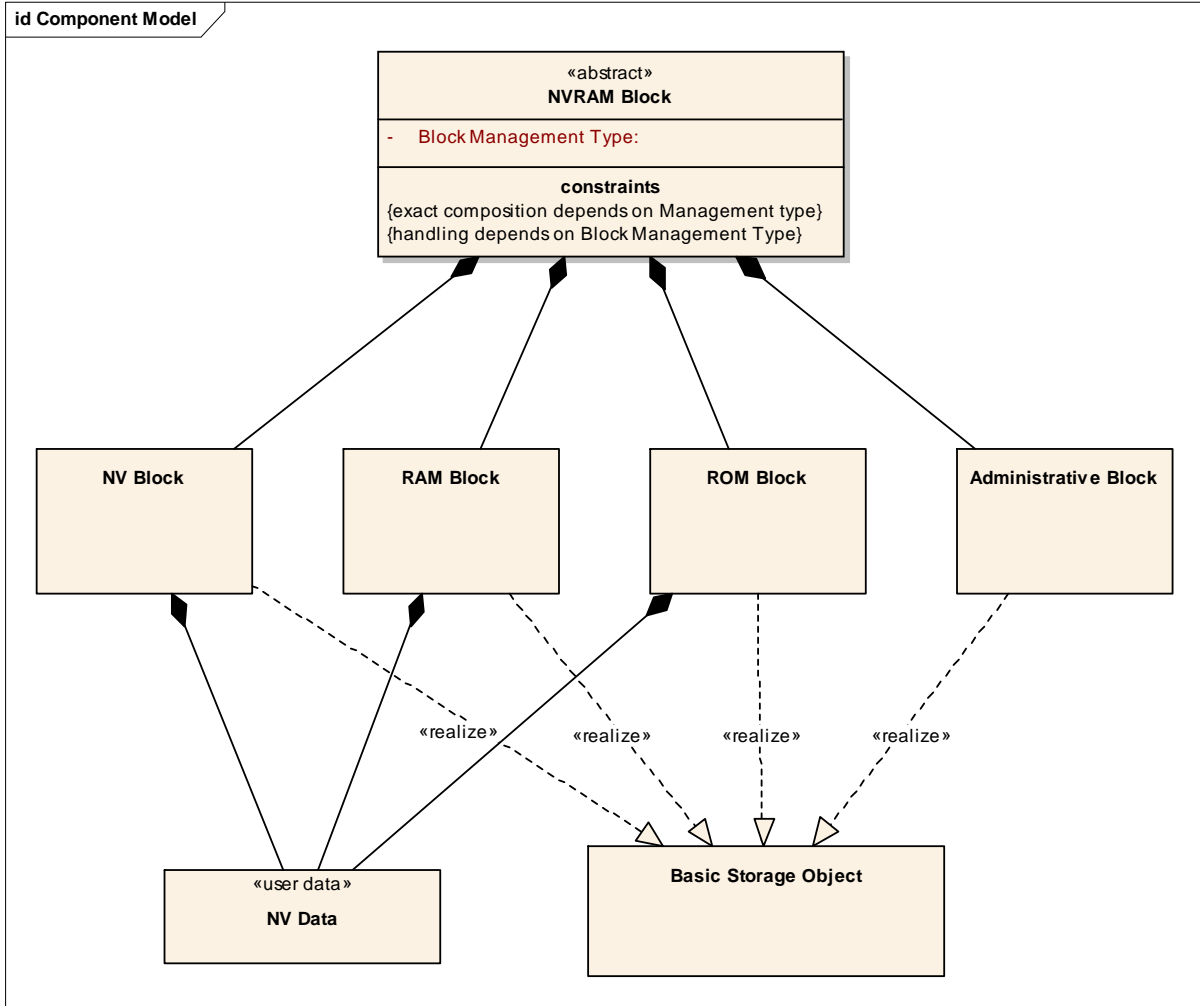

**Figure 1: Overview describing the acronyms table**

## 3 Related documentation

### 3.1 Input documents

- [1] Layered Software Architecture  
AUTOSAR\_LayeredSoftwareArchitecture.pdf
- [2] General Requirements on Basic Software Modules  
AUTOSAR\_SRS\_General.pdf
- [3] Requirements on Memory Services  
AUTOSAR\_SRS\_MemoryServices.pdf
- [4] Specification of EEPROM Abstraction  
AUTOSAR\_SWS\_EA.pdf
- [5] Specification of Flash EEPROM Emulation  
AUTOSAR\_SWS\_FLASH\_EEPROM\_Emulation.pdf
- [6] Specification of Memory Abstraction Interface  
AUTOSAR\_SWS\_MemIf.pdf
- [7] Specification of the Virtual Functional Bus  
AUTOSAR\_Spec\_of\_VFB.pdf
- [8] Software Component Template  
AUTOSAR\_SoftwareComponentTemplate.pdf
- [9] Specification of RTE Software  
AUTOSAR\_SWS\_RTE.pdf
- [10] Specification of BSW Scheduler  
AUTOSAR\_SWS\_BSW\_Scheduler.pdf
- [11] Specification of ECU Configuration  
AUTOSAR\_ECU\_Configuration.pdf
- [12] AUTOSAR Basic Software Module Description Template,  
AUTOSAR\_BSW\_Module\_Description.pdf

## **4 Constraints and assumptions**

### **4.1 Limitations**

Limitations are given mainly by the finite number of “Block Management Types” and their individual treatment of NV data. These limits can be reduced by an enhanced user defined management information, which can be stored as a structured part of the real NV data. In this case the user defined management information has to be interpreted and handled by the application at least.

### **4.2 Applicability to car domains**

No restrictions.

### **4.3 Conflicts**

None

## 5 Dependencies to other modules

This section describes the relations to other modules within the basic software.

### 5.1 File structure

#### 5.1.1 Code file structure

**NVM076:** The NvM module shall consist of the following parts:

- One or more C file NvM\_XXX.c containing the entire or parts of NVRAM manager code

#### 5.1.2 Header file structure

**NVM077:** The include file structure shall be as follows:

- An API interface NvM.h providing the function prototypes to access the underlying NVRAM functions
- A type header NvM\_Types.h providing the types for the NvM module
- A callback interface NvM\_Cbk.h providing the callback function prototypes to be used by the lower layers
- A type header NvM\_Cfg.h providing the configuration parameters for the NvM module
- NvM\_Cfg.h shall include NvM\_Types.h
- NvM\_Types.h shall include Std\_Types.h
- NvM.h shall include NvM\_Cfg.h
- NvM.c shall include NvM.h, Dem.h, MemIf.h, SchM\_NvM.h, MemMap.h, Crc.h and optionally Det.h

Only NvM.h shall be included by the upper layer.

### 5.2 Memory abstraction modules

The memory abstraction modules abstract the NvM module from the subordinated drivers which are hardware dependent. The memory abstraction modules provide a runtime translation of each block access initiated by the NvM module to select the corresponding driver functions which are unique for all configured EEPROM or FLASH storage devices. The memory abstraction module is chosen via the NVRAM block device ID which is configured for each NVRAM block.

### 5.3 CRC module

The NvM module uses CRC generation routines (16/32 bit) to check and to generate CRC for NVRAM blocks as a configurable option. The CRC routines have to be provided externally [ref. to ch. 8.6.2].

### 5.4 Capability of the underlying drivers

A set of underlying driver functions has to be provided for every configured NVRAM device as, for example, internal or external EEPROM or FLASH devices. The unique driver functions inside each set of driver functions are selected during runtime via a memory hardware abstraction module (see chapter 5.2). A set of driver functions has to include all the needed functions to write to, to read from or to maintain (e.g. erase) a configured NVRAM device.

## 6 Requirements traceability

Document: General requirements on Basic Software Modules

<b>Requirement</b>	<b>Satisfied by</b>
[BSW00344] Reference to link-time configuration	Not applicable (currently the NVM is only pre-compile-time configurable)
[BSW00404] Reference to post build time configuration	Not applicable (currently the NVM is only pre-compile-time configurable)
[BSW00405] Reference to multiple configuration sets	Not applicable (currently the NVM is only pre-compile-time configurable)
[BSW00345] Pre-compile-time configuration	<a href="#">NVM095</a>
[BSW159] Tool-based configuration	<a href="#">NVM095</a>
[BSW167] Static configuration checking	<a href="#">NVM028</a> , <a href="#">NVM061</a>
[BSW170] Data for reconfiguration of AUTOSAR SW-components	Not applicable (NVM is no AUTOSAR SW-C)
[BSW00380] Separate C-File for configuration parameters	Not applicable (currently the NVM is only pre-compile-time configurable)
[BSW00419] Separate C-Files for pre-compile time configuration parameters	<a href="#">NVM321</a>
[BSW00381] Separate configuration header file for pre-compile time parameters	<a href="#">NVM028</a>
[BSW00412] Separate H-File for configuration parameters	Not applicable (currently the NVM is only pre-compile-time configurable)
[BSW00383] List dependencies of configuration files	<a href="#">NVM095</a> , <a href="#">NVM319</a> , <a href="#">NVM320</a>
[BSW00384] List dependencies to other module	<a href="#">NVM319</a> , <a href="#">NVM320</a>
[BSW00385] List possible error notifications	<a href="#">NVM023</a> , <a href="#">NVM027</a>
[BSW00386] Configuration for detecting an error	<a href="#">NVM023</a> , <a href="#">NVM027</a> , <a href="#">NVM025</a>
[BSW00387] Specify the configuration class of callback functions	<a href="#">NVM330</a> , <a href="#">NVM331</a>
[BSW00388] Introduce containers	<a href="#">NVM028</a> , <a href="#">NVM061</a> , <a href="#">NVM095</a>
[BSW00389] Containers shall have names	<a href="#">NVM028</a> , <a href="#">NVM061</a> , <a href="#">NVM095</a>
[BSW00390] Parameter content shall be unique within the module	<a href="#">NVM028</a> , <a href="#">NVM061</a> , <a href="#">NVM095</a>
[BSW00391] Parameter shall have unique names	<a href="#">NVM028</a> , <a href="#">NVM061</a> , <a href="#">NVM095</a>
[BSW00392] Parameters shall have a type	<a href="#">NVM028</a> , <a href="#">NVM061</a> , <a href="#">NVM095</a>
[BSW00393] Parameters shall have a range	<a href="#">NVM028</a> , <a href="#">NVM061</a> , <a href="#">NVM095</a>
[BSW00394] Specify the scope of the parameters	<a href="#">NVM028</a> , <a href="#">NVM061</a> , <a href="#">NVM095</a>
[BSW00395] List the required parameters (per parameter)	<a href="#">NVM028</a> , <a href="#">NVM061</a> , <a href="#">NVM095</a>
[BSW00396] Configuration classes	<a href="#">NVM028</a> , <a href="#">NVM061</a> , <a href="#">NVM095</a>
[BSW00397] Pre-compile-time parameters	<a href="#">NVM028</a> , <a href="#">NVM061</a> , <a href="#">NVM095</a>
[BSW00398] Link-time-parameters	Not applicable (currently the NVM is only pre-compile-time configurable)
[BSW00399] Loadable post-build time parameters	Not applicable (currently the NVM is only pre-compile-time configurable)
[BSW00400] Selectable post-build time parameters	Not applicable (currently the NVM is only pre-compile-time

	configurable)
[BSW00402] Published information	<a href="#">NVM022</a>
[BSW101] Initialization interface	<a href="#">NVM399</a> , <a href="#">NVM400</a>
[BSW00416] Sequence of Initialization	Not applicable (the NvM module isn't responsible for any BSW module initialization)
[BSW00406] Check module initialization	<a href="#">NVM399</a> , <a href="#">NVM400</a> , <a href="#">NVM027</a> , <a href="#">NVM023</a>
[BSW003] Version identification	<a href="#">NVM022</a>
[BSW004] Version check	<a href="#">NVM089</a>
[BSW00337] Classification of errors	<a href="#">NVM023</a> , <a href="#">NVM024</a>
[BSW00338] Detection and reporting of development errors	<a href="#">NVM025</a>
[BSW168] Diagnostic Interface	Not applicable (no use case for the NvM module)
[BSW00407] Function to read out published parameters	<a href="#">NVM285</a> , <a href="#">NVM286</a>
[BSW00423] Usage of SW-C template to describe BSW modules with AUTOSAR Interfaces	Not applicable
[BSW00424] BSW main processing function task allocation [approved]	<a href="#">NVM322</a>
[BSW00425] Trigger conditions for schedulable objects	<a href="#">NVM464</a>
[BSW00426] Exclusive areas in BSW modules	Not applicable
[BSW00427] ISR description for BSW modules	Not applicable (NVM doesn't use ISRs)
[BSW00428] Execution order dependencies of main processing functions	<a href="#">NVM324</a>
[BSW00429] Restricted BSW OS functionality access	<a href="#">NVM332</a>
[BSW00431] The BSW Scheduler module implements task bodies	Not applicable (Requirement on implementation, not on specification)
[BSW00432] Modules should have separate main processing functions for read/receive and write/transmit data path	Not applicable (read and write jobs are handled in a serialized way, not in parallel)
[BSW00433] Calling of main processing functions	<a href="#">NVM324</a>
[BSW00434] The Schedule Module shall provide an API for exclusive areas	Not applicable (Requirement for schedule module)
[BSW00375] Notification of wake-up reason	Not applicable (no use case)
[BSW00339] Reporting of production relevant errors status	<a href="#">NVM026</a>
[BSW00369] Do not return development error codes via API	<a href="#">NVM025</a>
[BSW00421] Reporting of production relevant error events	<a href="#">NVM319</a>
[BSW00422] Debouncing of production relevant error status	Not applicable (NVM uses Dem_ReportError API for error reporting)
[BSW00420] Production relevant error event rate detection	Not applicable (Requirement belongs to Dem)
[BSW00417] Reporting of Error Events by Non-Basic Software	Not applicable (NVM is a BSW module)
[BSW00409] Header files for production code error IDs	<a href="#">NVM186</a>
[BSW00336] Shutdown interface	Not applicable (no use case)
[BSW171] Configurability of optional functionality	<a href="#">NVM028</a>



[BSW00323] API parameter checking	<a href="#">NVM027</a>
[BSW00373] Main processing function naming convention	<a href="#">NVM464</a>
[BSW161] Microcontroller abstraction	Not applicable (Requirement on AUTOSAR architecture, not a single module)
[BSW162] ECU layout abstraction	Not applicable (Requirement on AUTOSAR architecture, not a single module)
[BSW00324] Do not use HIS I/O Library	Not applicable (architecture decision)
[BSW005] No hard coded horizontal interfaces within MCAL	Not applicable (Requirement on AUTOSAR architecture, not a single module)
[BSW00415] User dependent include files	Not applicable (NVM doesn't provide restricted access for several modules)
[BSW164] Implementation of interrupt service routines	Not applicable (this module doesn't implement any ISRs)
[BSW00325] Runtime of interrupt service routines	Not applicable (this module doesn't implement any ISRs)
[BSW00326] Transition from ISRs to OS tasks	Not applicable (this module doesn't implement any ISRs)
[BSW00342] Usage of source code and object code	Not applicable (Requirement on AUTOSAR architecture, not a single module)
[BSW00343] Specification and configuration of time	Not applicable (no configurable timings)
[BSW160] Human-readable configuration data	Not applicable (Requirement on documentation, not on specification)
[BSW007] HIS MSIRA C	Not applicable (Requirement on implementation, not on specification)
[BSW00300] Module naming convention	Chapter 5.1
[BSW00413] Accessing instances of BSW modules	Conflict: This requirement will have impact on almost all BSW modules, therefore it can not be implemented within the Release 2.0 timeframe.
[BSW00347] Naming separation of different instances of BSW drivers	Not applicable (Requirement on implementation, not on specification)
[BSW00305] Self-defined data types naming convention	Chapter 8.2
[BSW00307] Global variables naming convention	Not applicable (Requirement on implementation, not on specification)
[BSW00310] API naming convention	Chapters 8.3, 0, 0
[BSW00327] Error values naming convention	<a href="#">NVM023</a> , <a href="#">NVM027</a>
[BSW00335] Status values naming convention	Not applicable (no status values available)
[BSW00350] Development error detection keyword	<a href="#">NVM025</a> , <a href="#">NVM188</a>
[BSW00408] Configuration parameter naming convention	Chapter 10
[BSW00410] Compiler switches shall have defined values	Chapter 10
[BSW00411] Get version info keyword	<a href="#">NVM286</a> , Chapter 10
[BSW00346] Basic set of module files	Chapter 5.1

[BSW158] Separation of configuration from implementation	Chapter 5.1
[BSW00314] Separation of interrupt frames and service routines	Not applicable (this module doesn't implement any ISRs)
[BSW00370] Separation of callback interface from API	Chapter 5.1
[BSW00348] Standard type header	Not applicable (this module simply includes the standard type header via the module header file)
[BSW00353] Platform specific type header	Not applicable (this module simply includes the standard type header via the module header file)
[BSW00361] Compiler specific language extension header	Not applicable (this module simply includes the standard type header via the module header file)
[BSW00301] Limit imported information	Chapter 5.1
[BSW00302] Limit exported information	Not applicable (Requirement on the implementation, not on the specification)
[BSW00328] Avoid duplication of code	Not applicable (Requirement on the implementation, not on the specification)
[BSW00312] Shared code shall be reentrant	Not applicable (Requirement on the implementation, not on the specification)
[BSW006] Platform independency	Not applicable (Requirement on the implementation, not on the specification)
[BSW00357] Standard API return type	Chapter 8.1, 8.2
[BSW00377] Module specific API return types	Chapter 8.2
[BSW00304] AUTOSAR integer data types	Not applicable (Requirement on implementation, not for specification)
[BSW00355] Do not redefine AUTOSAR integer data types	Not applicable (Requirement on implementation, not for specification)
[BSW00378] AUTOSAR boolean type	Not applicable (Requirement on implementation, not for specification)
[BSW00306] Avoid direct use of compiler and platform specific keywords	Not applicable (Requirement on implementation, not for specification)
[BSW00308] Definition of global data	Not applicable (Requirement on implementation, not for specification)
[BSW00309] Global data with read-only constraint	Not applicable (Requirement on implementation, not for specification)
[BSW00371] Do not pass function pointers via API	Not applicable (no function pointers in this specification)
[BSW00358] Return type of init() functions	Chapter 8.3.1.1
[BSW00414] Parameter of init function	Chapter 8.3.1.1
[BSW00376] Return type and parameters of main processing functions	<a href="#">NVM106</a>
[BSW00359] Return type of callback functions	Chapter 8.6.3.1, 0
[BSW00360] Parameters of callback functions	Chapter 8.6.3.1, 0
[BSW00329] Avoidance of generic interfaces	Chapter 8.3
[BSW00330] Usage of macros / inline functions	Not applicable

instead of functions	Requirement on implementation, not for specification)
[BSW00331] Separation of error and status values	<a href="#">NVM023</a> , <a href="#">NVM027</a>
[BSW009] Module User Documentation	Not applicable (Requirement on documentation, not on specification)
[BSW00401] Documentation of multiple instances of configuration parameters	Chapter 10
[BSW172] Compatibility and documentation of scheduling strategy	<a href="#">NVM323</a> , <a href="#">NVM324</a>
[BSW010] Memory resource documentation	Not applicable (Requirement on documentation, not on specification)
[BSW00333] Documentation of callback function context	Chapter 8.6.3.1, 0
[BSW00374] Module vendor identification	<a href="#">NVM022</a>
[BSW00379] Module identification	<a href="#">NVM022</a>
[BSW003] Version identification	<a href="#">NVM022</a>
[BSW00318] Format of module version numbers	<a href="#">NVM022</a>
[BSW00321] Enumeration of module version numbers	Not applicable (Requirement on implementation, not for specification)
[BSW00341] Microcontroller compatibility documentation	Not applicable (Requirement on documentation, not on specification)
[BSW00334] Provision of XML file	Not applicable (Requirement on documentation, not on specification)
[BSW00435] Header File Structure for the Basic Software Scheduler	<a href="#">NVM077</a>
[BSW00436] Module Header File Structure for the Basic Software Memory Mapping	<a href="#">NVM077</a>

### Document: Requirements on Memory Services

<b>Requirement</b>	<b>Satisfied by</b>
[BSW041] Declaration and allocation of application memory	<a href="#">NVM030</a>
[BSW08534] Classes of RAM data blocks	<a href="#">NVM370</a> , <a href="#">NVM371</a> , <a href="#">NVM372</a> , <a href="#">NVM373</a>
[BSW08528] NVRAM block management type - native	<a href="#">NVM000</a>
[BSW08529] NVRAM block management type - redundant	<a href="#">NVM001</a> , <a href="#">NVM047</a>
[BSW08531] NVRAM block management type – dataset	<a href="#">NVM006</a>
[BSW08543] Static configuration of block priority	<a href="#">NVM032</a>
[BSW08009] Default write protection of blocks	<a href="#">NVM033</a> , <a href="#">NVM054</a>
[BSW135] NVRAM configuration ID	<a href="#">NVM034</a> , <a href="#">NVM073</a>
[BSW08549] Automatic initialization of RAM data after Software update	<a href="#">NVM116</a>
[BSW125] Job notification	NVM383, NVM384,
[BSW08000] Configurable access to multiple (different) devices	<a href="#">NVM035</a>
[BSW08001] Configuration of consistency check of data	<a href="#">NVM036</a> , <a href="#">NVM040</a>
[BSW08538] Static configuration of NVRAM blocks being loaded during start-up	<a href="#">NVM117</a> , <a href="#">NVM245</a> , <a href="#">NVM118</a>

[BSW08546] Protection of RAM data blocks against data loss [approved]	<a href="#">NVM119</a>
[BSW08533] Load data blocks from NVRAM to RAM	<a href="#">NVM008</a>
[BSW176] Only access non-volatile memory via NVRAM manager	<a href="#">NVM037</a> (note: this has to be handled on RTE level)
[BSW027] Accessing of non volatile data	<a href="#">NVM038</a>
[BSW08014] RAM block allocation	<a href="#">NVM088</a>
[BSW013] Handling of concurrent accesses to NVRAM	<a href="#">NVM378</a> , <a href="#">NVM379</a>
[BSW016] Block-wise reading of data	<a href="#">NVM010</a> <a href="#">NVM029</a>
[BSW017] Block-wise writing of data	<a href="#">NVM410</a> , <a href="#">NVM411</a>
[BSW08541] Guaranteed processing of accepted write requests	<a href="#">NVM380</a> , <a href="#">NVM381</a> , <a href="#">NVM152</a>
[BSW018] Block-wise restoring of default data	<a href="#">NVM012</a>
[BSW08548] Automatic initialization without ROM Block	<a href="#">NVM116</a>
[BSW08547] Distinction between invalidated and inconsistent data	NVM405, NVM406, <a href="#">NVM294</a> , <a href="#">NVM203</a> ,
[BSW08550] Marking blocks modified/unmodified	NVM405, NVM406, NVM432, NVM433, NVM434, <a href="#">NVM344</a> , <a href="#">NVM345</a>
[BSW08545] Validation of permanent RAM data blocks	NVM405, NVM406, <a href="#">NVM121</a> , <a href="#">NVM344</a> , <a href="#">NVM345</a>
[BSW08011] Invalidation of NVRAM data blocks	NVM421, NVM422, NVM423, NVM424
[BSW08544] Block-wise erasing of NVRAM data	NVM415, NVM416, NVM417, NVM418
[BSW08007] Selection of datasets	<a href="#">NVM014</a> , <a href="#">NVM021</a>
[BSW08542] Job order prioritization	<a href="#">NVM032</a>
[BSW020] Readout of current status of NVRAM manager operations	<a href="#">NVM015</a>
[BSW127] Write protect/unprotect function	<a href="#">NVM016</a> , <a href="#">NVM054</a>
[BSW030] Consistency/integrity check of data	<a href="#">NVM040</a> , <a href="#">NVM036</a> , <a href="#">NVM165</a>
[BSW034] Quasi-parallel write access	NVM378, NVM379
[BSW08535] Save data blocks from RAM to NV memory	<a href="#">NVM018</a>
[BSW08540] Aborting the shut down process	<a href="#">NVM019</a>
[BSW038] Treatable errors shall not affect other software components	<a href="#">NVM047</a> , <a href="#">NVM001</a>
[BSW129] Automatic data repair	<a href="#">NVM047</a> , <a href="#">NVM001</a>
[BSW08010] Loading of ROM default data	<a href="#">NVM012</a> , <a href="#">NVM020</a> , NVM387, NVM388
[BSW011] (Memory) hardware independence	<a href="#">NVM051</a>
[BSW130] Provide information about used memory resources	<a href="#">NVM052</a>
[BSW08015] NV Block security of ECU reprogramming	<a href="#">NVM072</a> , <a href="#">NVM276</a>

## 7 Functional specification

### 7.1 Basic architecture guidelines

#### 7.1.1 Layer structure

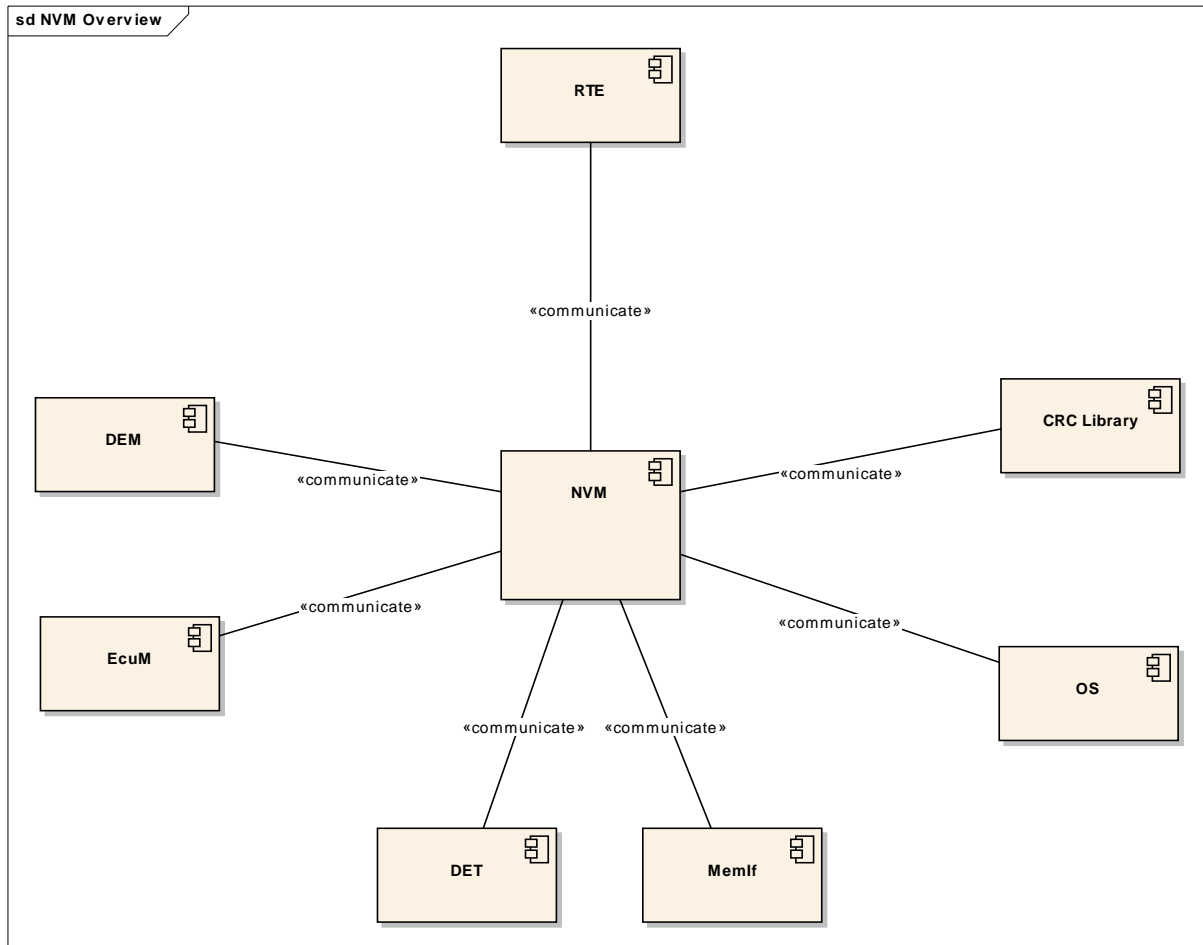

Figure 2: NVRAM Manager interactions overview

#### 7.1.2 Addressing scheme for the memory hardware abstraction

**NVM051:** The Memory Abstraction Interface, the underlying Flash EEPROM Emulation and EEPROM Abstraction Layer provide the NvM module with a virtual linear 32bit address space which is composed of a 16bit logical block number and a 16bit block address offset.

**Hint:** According to NVM051, the NvM module can allow for a (theoretical) number of 65536 logical blocks, each logical block can have a (theoretical)<sup>1</sup> size of up to 64 Kbytes.

**NVM122:** The NvM module shall further subdivide the 16bit logical block number into the following parts:

- block identifier with the size of  $(16 - \text{NvmDatasetSelectionBits})$  bits
- `NvmDatasetSelectionBits` bit data index, allowing for up to 256 datasets per NVRAM block

**NVM343:** Handling/addressing of redundant NVRAM blocks shall be done towards the memory hardware abstraction in the same way like for dataset NVRAM blocks, i.e. the redundant NV blocks shall be managed by usage of the configuration parameter `NvmDatasetSelectionBits`.

**NVM123:** The NvM module shall store the block identifier in the most significant bits of the 16bit logical block number.

**NVM442:** The configuration tool shall configure the block identifiers.

**NVM443:** The NvM module shall not modify the configured block identifiers.

### 7.1.2.1 Examples of addressing scheme for the memory hardware abstraction

To clarify the previously described addressing scheme which is used for NVRAM manager ↔ memory hardware abstraction interaction, the following examples shall help to understand the correlations between the configuration parameters `NvmNvBlockBaseNumber`, `NvmDatasetSelectionBits` on NVRAM manager side and `EA_BLOCK_NUMBER` / `FEE_BLOCK_NUMBER` on memory hardware abstraction side [NVM061].

For the given examples A and B a simple formula is used:

$$\text{FEE/EA\_BLOCK\_NUMBER} = \text{NvmNvBlockBaseNumber} + \text{NvmDatasetSelectionBits}$$

**Example A:**

The configuration parameter `NvmDatasetSelectionBits` is configured to be 2. This leads to the result that 14 bits are available as range for the configuration parameter `NvmNvBlockBaseNumber`.

⇒ Range of `NvmNvBlockBaseNumber`: 0x1..0x3FFE

⇒ Range of `NvmDatasetSelectionBits`: 0x0..0x3

⇒ Range of `FEE_BLOCK_NUMBER/EA_BLOCK_NUMBER`: 0x4..0xFFFFB

**Example B:**

The configuration parameter `NvmDatasetSelectionBits` is configured to be 4. This leads to the result that 12 bits are available as range for the configuration parameter `NvmNvBlockBaseNumber`.

<sup>1</sup> "Theoretical" meaning here that we don't expect anyone to use the NVRAM manager and underlying layers in exactly this way.

- ⇒ Range of `NvmNvBlockBaseNumber`: 0x1..0xFFE
- ⇒ Range of `NvmDatasetSelectionBits`: 0x0..0xF
- ⇒ Range of `FEE/EA Block Number`: 0x10..0xFFEF

### 7.1.3 Basic storage objects

#### 7.1.3.1 NV block

**NVM125:** The NV block is a basic storage object and represents a memory area consisting of NV user data and (optionally) a CRC value.

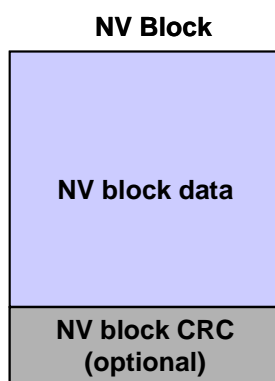

Figure 3: NV Block layout

Note: This figure does not show the physical memory layout of an NV block. Only the logical clustering is shown.

#### 7.1.3.2 RAM block

**NVM126:** The RAM block is a basic storage object and represents an area in RAM consisting of user data and (optionally) a CRC value.

**NVM127:** Restrictions on CRC usage on RAM blocks. CRC is only available if the corresponding NV block(s) also have a CRC. CRC has to be of the same type as that of the corresponding NV block(s). [\[NVM061\]](#)

**NVM129:** The user data area of a RAM block can reside in a different RAM address location (global data section) than the state of the RAM block.

**NVM130:** The data area of a RAM block shall be accessible from NVRAM Manager and from the application side (data passing from/to the corresponding NV block).

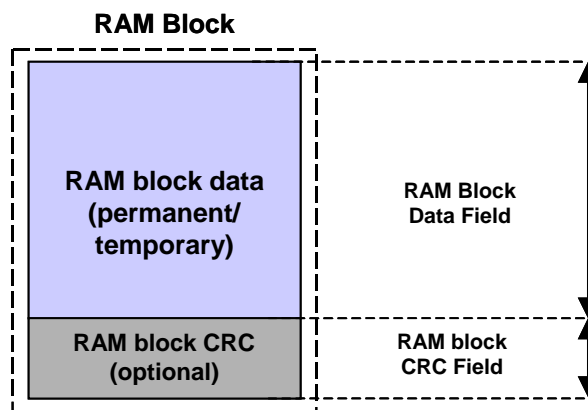

**Figure 4:** RAM Block layout

Note: This figure does not show the physical memory layout of a RAM block. Only the logical clustering is shown.

As the NvM module doesn't support alignment, this could be managed by configuration, i.e. the block length could be enlarged by adding padding to meet alignment requirements.

**NVM373:** The RAM block data shall contain the permanently or temporarily assigned user data.

**NVM371:** The RAM block data is assigned to exactly one SW-Component or BSW module.

**NVM370:** In case of permanently assigned user data, the address of the RAM block data is known during configuration time.

**NVM372:** In case of temporarily assigned user data, the address of the RAM block data is not known during configuration time and will be passed to the NvM module during runtime. The RAM block data can be used e.g. as a shared buffer for several SW-Components or BSW modules.

**NVM088:** It shall be possible to allocate each RAM block without address constraints in the global RAM area. The whole number of configured RAM blocks needs not be located in a continuous address space.

### 7.1.3.3 ROM block

**NVM020:** The ROM block is a basic storage object, resides in the ROM (FLASH) and is used to provide default data in case of an empty or damaged NV block.



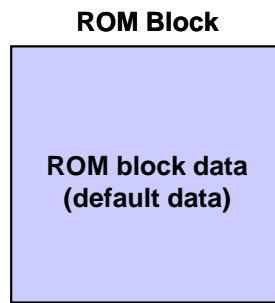

**Figure 5: ROM block layout**

#### 7.1.3.4 Administrative block

**NVM134:** The Administrative block shall be located in RAM and shall contain a block index which is used in association with Dataset NV blocks. Additionally, attribute/error/status information of the corresponding NVRAM block shall be contained.

**NVM128:** The NvM module shall use state information of the permanent RAM block (invalid/valid) to determine the validity of the permanent RAM block user data.

**NVM132:** The RAM block state „invalid“ indicates that the data area of the respective RAM block is invalid. The RAM block state „valid“ indicates that the data area of the respective RAM block is valid.

**NVM133:** The value of “invalid” shall be represented by all other values except “valid”.

**NVM135:** The Administrative block shall be invisible for the application and is used exclusively by the NvM module for security and administrative purposes of the RAM block and the NVRAM block itself.

**NVM054:** The NvM module shall use an attribute field to manage the NV block write protection in order to protect/unprotect a NV block data field.

**NVM136:** The NvM module shall use an error/status field to manage the error/status value of the last request [[NVM083](#)].

## 7.1.4 Block management types

### 7.1.4.1 Block management types overview

**NVM137:** The following types of NVRAM storage shall be supported by the NvM module implementation and consist of the following basic storage objects:

<i>Management Type</i>	<i>NV Blocks</i>	<i>RAM Blocks</i>	<i>ROM Blocks</i>	<i>Administrative Blocks</i>
NVM_BLOCK_NATIVE	1	1	0..1	1
NVM_BLOCK_REDUNDANT	2	1	0..1	1
NVM_BLOCK_DATASET	1..(m<256)*	1	0..n	1

\* The number of possible datasets depends on the configuration parameter `NvmDatasetSelectionBits`.

### 7.1.4.2 NVRAM block structure

**NVM138:** The NVRAM block shall consist of the mandatory basic storage objects NV block, RAM block and Administrative block.

**NVM139:** The basic storage object ROM block is optional.

**NVM140:** The composition of any NVRAM block is fixed during configuration by the corresponding NVRAM block descriptor.

**NVM141:** All address offsets are given relatively to the start addresses of RAM or ROM in the NVRAM block descriptor. The start address is assumed to be zero. A device specific base address or offset will be added by the respective device driver if needed.

For details of the NVRAM block descriptor see chapter 7.1.4.3.

### 7.1.4.3 NVRAM block descriptor table

**NVM069:** A single NVRAM block to deal with will be selected via the NvM module API by providing a subsequently named Block ID.

**NVM143:** All structures related to the NVRAM block descriptor table and their addresses in ROM (FLASH) have to be generated during configuration of the NvM module.

### 7.1.4.4 Native NVRAM block

The Native NVRAM block is the simplest block management type. It allows storage to/retrieval from NV memory with a minimum of overhead.

**NVM000:** The Native NVRAM block consists of a single NV block, RAM block and Administrative block.

**7.1.4.5 Redundant NVRAM block**

In addition to the Native NVRAM block, the Redundant NVRAM block provides enhanced fault tolerance, reliability and availability. It increases resistance against data corruption.

**NVM001:** The Redundant NVRAM block consists of two NV blocks, a RAM block and an Administrative block.

The following figure reflects the internal structure of the NV memory:

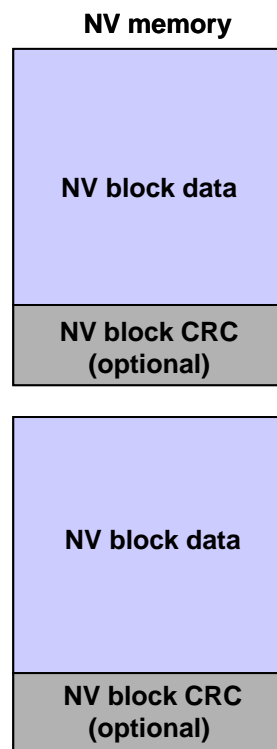

**Figure 6: Redundant NVRAM Block layout**

Note: This figure does not show the physical NV memory layout of a redundant NVRAM block. Only the logical clustering is shown.

**7.1.4.6 Dataset NVRAM block**

The Dataset NVRAM block is an array of equally sized data blocks (NV/ROM). The application can at one time access exactly one of these elements.

**NVM006:** The Dataset NVRAM block consists of multiple NV user data and (optionally) CRC areas, a RAM block and an Administrative block.

**NVM144:** The index position of the dataset is noticed via a separated field in the corresponding Administrative block.

**NVM374:** The NvM module shall be able to read all assigned NV blocks.

**NVM375:** The NvM module shall only be able to write to all assigned NV blocks if (and only if) write protection is disabled.

**NVM146:** If the basic storage object ROM block is selected as optional part, the index range which normally selects a dataset is extended to the ROM to make it possible to select a ROM block instead of a NV block. The index covers all NV/ROM blocks which may build up the NVRAM Dataset block.

**NVM376:** The NvM module shall be able to only read optional ROM blocks (default datasets).

**NVM377:** The NvM module shall treat a write to a ROM block like a write to a protected NV block.

**NVM444:** The total number of configured datasets (NV+ROM blocks) must be in the range of 1..255.

**NVM445:** In case of optional ROM blocks, data areas with an index from 0 up to  $NvmNvBlockNum-1$  represent the NV blocks with their CRC in the NV memory. Data areas with an index from  $NvmNvBlockNum$  up to  $NvmNvBlockNum+NvmRomBlockNum$  represent the ROM blocks.

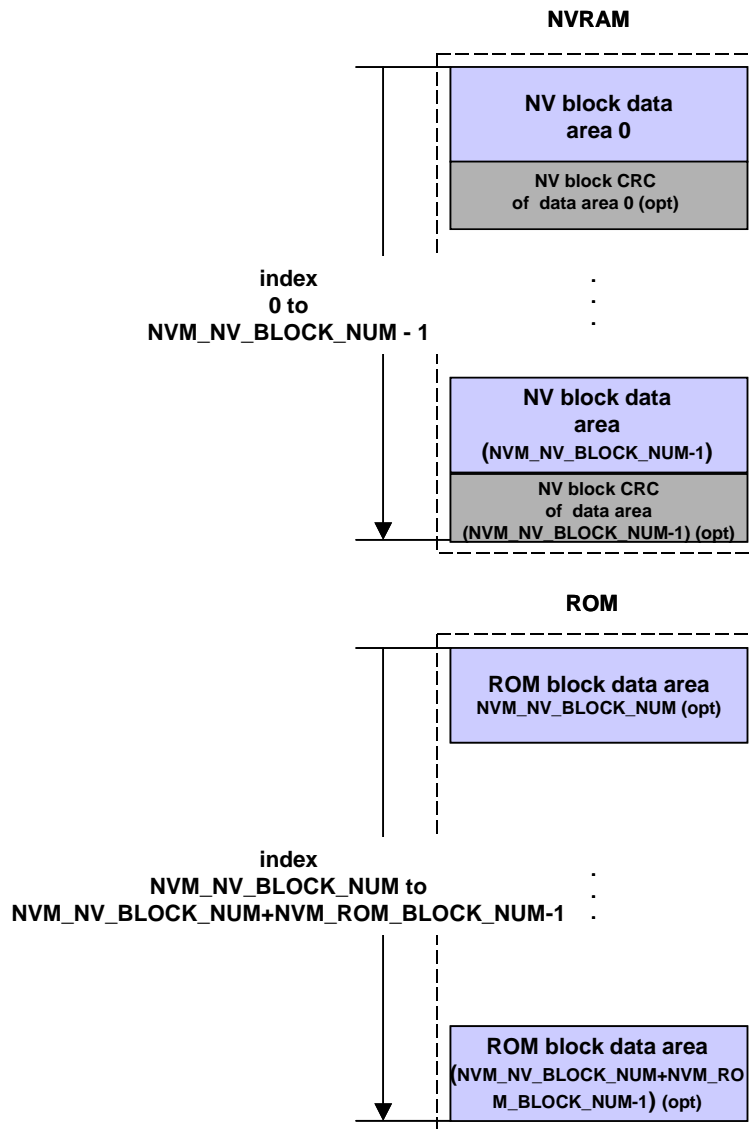

Figure 7: Dataset NVRAM block layout

Note: This figure does not show the physical NV memory layout of a Dataset NVRAM block. Only the logical clustering is shown.

#### 7.1.4.7 NVRAM Manager API configuration classes

**NVM149:** To have the possibility to adapt the NvM module to limited hardware resources, three different API configuration classes shall be defined:

- **API configuration class 3:**  
All specified API calls are available. A maximum of functionality is supported.
- **API configuration class 2:**  
An intermediate set of API calls is available.
- **API configuration class 1:**

Especially for matching systems with very limited hardware resources this API configuration class offers only a minimum set of API calls which are required in any case.

<b>API configuration class 3</b>	<b>API configuration class 2</b>	<b>API configuration class 1</b>
Type 1: NvM_SetDataIndex (...) NvM_GetDataIndex (...) NvM_SetBlockProtection (...) NvM_GetErrorStatus(...) NvM_SetRamBlockStatus(...)	Type 1: NvM_SetDataIndex (...) NvM_GetDataIndex (...) NvM_GetErrorStatus(...) NvM_SetRamBlockStatus(...)	Type 1: NvM_GetErrorStatus(...) NvM_SetRamBlockStatus(...)
Type 2: NvM_ReadBlock(...) NvM_WriteBlock(...) NvM_RestoreBlockDefaults(...) NvM_EraseNvBlock(...) NvM_InvalidateNvBlock(...)	Type 2: NvM_ReadBlock(...) NvM_WriteBlock(...) NvM_RestoreBlockDefaults(...)	Type 2: --
Type 3: NvM_ReadAll(...) NvM_WriteAll(...) NvM_CancelWriteAll(...)	Type 3: NvM_ReadAll(...) NvM_WriteAll(...) NvM_CancelWriteAll(...)	Type 3: NvM_ReadAll(...) NvM_WriteAll(...) NvM_CancelWriteAll(...)
Type 4: NvM_Init(...)	Type 4: NvM_Init(...)	Type 4: NvM_Init(...)

Note: For API configuration class 1 no queues are needed, no immediate data can be written. Furthermore the API call `NvM_SetRamBlockStatus` is only available if configured by `NvmSetRamBlockStatusApi`.

**NVM365:** Within API configuration class 1, the block management type `NVM_BLOCK_DATASET` is not supported.

For information regarding the definition of Type 1...4 ref. to chapter 8.7.

**NVM150:** The NvM module shall only contain that code that is needed to handle the configured block types.

### 7.1.5 Scan order / priority scheme

**NVM032:** The NvM module shall support a priority based job processing. By configuration parameter `NvmJobPrioritization` [NVM028] priority based job processing shall be enabled/disabled.

**NVM378:** In case of priority based job processing order, the NvM module shall use two queues, one for immediate write jobs (crash data) another for all other jobs (including immediate read/erase jobs).

**NVM379:** If priority based job processing is disabled via configuration, the NvM module shall not support immediate write jobs. In this case, the NvM module processes all jobs in FCFS order.

**NVM380:** The job queue length for multi block requests originating from the `NvM_ReadAll` and `NvM_WriteAll` shall be one (only one job is queued).

**NVM381:** The NvM module shall not interrupt jobs originating from the `NvM_ReadAll` and `NvM_WriteAll` request by other requests. The NvM module shall rather queue read / write jobs that are requested during an ongoing `NvM_ReadAll` / `NvM_WriteAll` request and executed them subsequently.

Note: The `NvM_WriteAll` request can be aborted by calling `NvM_CancelWriteAll`. In this case, the current block is processed completely but no further blocks are written [NVM238].

Hint: It shall be allowed to dequeue requests, if they became obsolete by completion of the regarding NVRAM block.

**NVM152:** The only exception to the rule given in [NVM380, NVM381] is a write job with immediate priority which shall preempt the running read / write job. The preempted job shall subsequently be resumed / restarted by the NvM module.

## 7.2 General behavior

### 7.2.1 Functional requirements

**NVM383:** For each asynchronous request, a notification of the caller after completion of the job shall be a configurable option.

**NVM384:** The NvM module shall provide a callback interface [NVM113].

**NVM037:** The NvM module's environment shall access the non-volatile memory via the NvM module only. It shall not be allowed for any module (except for the NvM module) to access the non-volatile memory directly.

**NVM038:** The NvM module only provides an implicit way of accessing blocks in the NVRAM and in the shared memory (RAM). This means, the NvM module copies one or more blocks from NVRAM to the RAM and the other way round.

The application accesses the RAM data directly, with respect to given restrictions (e.g. synchronization).

**NVM385:** The NvM module shall queue all asynchronous “single block” read/write/control requests if the block with its specific ID is not already queued or currently in progress (multitasking restrictions).

**NVM386:** The NvM module shall accept multiple asynchronous “single block” requests as long as no queue overflow occurs.

**NVM155:** The highest priority request shall be fetched from the queues by the NvM module and processed in a serialized order.

**NVM040:** The NvM module shall implement implicit mechanisms for consistency / integrity checks of data saved in NV memory [\[NVM165\]](#).

**NVM156:** Depending on implementation, callback routines provided and/or invoked by the NvM module may be called in interrupt context. The NvM module providing those routines has therefore to make sure that their runtime is reasonably short.

**NVM042:** The NvM module shall be able to detect corrupted / invalid data during `NvM_ReadAll` by performing a checksum calculation and/or testing the RAM block validity, which is managed in the administrative block. [\[NVM036\]](#) [\[NVM008\]](#)

**NVM085:** If there is no default ROM data available at configuration time or no callback defined by `NvmInitBlockCallback` then the application shall be responsible for providing the default initialization data.

In this case, the application has to use `NvM_GetErrorStatus()` to be able to distinguish [\[NVM061\]](#) between first initialization and corrupted data. [\[NVM083\]](#)

**NVM387:** During processing of `NvM_ReadAll`, the NvM module shall be able to detect corrupted / invalid RAM data by performing a checksum calculation and/or testing the validity of a data within the administrative block.

**NVM388:** During startup phase and normal operation of `NvM_ReadAll` and if the NvM module has detected an unrecoverable error within the NV block, the NvM module shall copy default data (if configured) to the corresponding RAM block.

**NVM332:** The NvM module shall use the BSW scheduler only, i.e. instead of directly making use of OS objects and/or related OS services.

## 7.2.2 Design notes

### 7.2.2.1 NVRAM manager startup

`NvM_Init` shall be invoked by the ECU state manager exclusively.

**NVM091:** Due to strong constraints concerning the ECU startup time, the `NvM_Init` request shall not contain the initialization of the configured NVRAM blocks.



**NVM157:** The `NvM_Init` request shall not be responsible to trigger the initialization of underlying drivers and memory hardware abstraction. This shall also be handled by the ECU state manager.

**NVM158:** The initialization of the RAM data blocks shall be done by another request, namely `NvM_ReadAll` [NVM008].

`NvM_ReadAll` shall be called exclusively by the ECU state manager.

Software components which use the NvM module shall be responsible for checking global error/status information resulting from the NvM module startup. The ECU state manager shall use polling by using `NvM_GetErrorStatus` [NVM015] (reserved block ID 0) or callback notification (configurable option `NvmMultiBlockCallback` [NVM028]) to derive global error/status information resulting from startup. If polling is used, the end of the NVRAM startup procedure shall be detected by the global error/status `NVM_REQ_OK` or `NVM_REQ_NOT_OK` (during startup `NVM_REQ_PENDING`) [NVM083]. If callbacks are chosen for notification, software components shall be notified automatically if an assigned NVRAM block has been processed.[NVM281].

Note 1: If callbacks are configured for each NVRAM block which is processed within `NvM_ReadAll`, they can be used by the RTE to start e.g. SW-Cs at an early point of time.

Note 2: To ensure that the DEM is fully operational at an early point of time, i.e. its NV data is restored to RAM, DEM related NVRAM blocks should be configured to have a low ID to be processed first within `NvM_ReadAll`.

**NVM160:** The NvM module shall not store the currently used Dataset index automatically in a persistent way.

Software components shall check the specific error/status of all blocks they are responsible for by using `NvM_GetErrorStatus` [NVM015] with specific block IDs to determine the validity of the corresponding RAM blocks.

For all blocks of the block management type “NVRAM Dataset” [NVM006] the software component shall be responsible to set the proper index position by `NvM_SetDataIndex` [NVM014]. E.g. the current index position can be stored/maintained by the software component in a unique NVRAM block. To get the current index position of a “Dataset Block”, the software component shall use the `NvM_GetDataIndex` [NVM021] API call.

### 7.2.2.2 NVRAM manager shutdown

**NVM092:** The basic shutdown procedure shall be done by the request `NvM_WriteAll` [NVM018].

Hint: `NvM_WriteAll` shall be invoked by the ECU state manager.

### 7.2.2.3 (Quasi) parallel write access to the NvM module

**NVM162:** The NvM module shall receive the requests via an asynchronous interface using a queuing mechanism. The NvM module shall process all requests serially depending on their priority.

### 7.2.2.4 Avoid infinite loops

**NVM163:** The DEM is responsible for handling the loop detection.

### 7.2.2.5 NVRAM block consistency check

**NVM164:** The NvM module shall provide implicit techniques to check the data consistency of NVRAM blocks [\[NVM036\]](#), [\[NVM040\]](#). The data consistency check of a NVRAM block shall be done by CRC recalculations of its corresponding NV block(s).

**NVM165:** The implicit way of a data consistency check shall be provided by configurable options of the internal functions. The implicit consistency check shall be configurable for each NVRAM block and depends on the configurable parameters `NvmBlockUseCrc` and `NvmCalcRamBlockCrc` [\[NVM061\]](#).

### 7.2.2.6 Error recovery

**NVM047:** The NvM module shall provide techniques for error recovery. The error recovery depends on the NVRAM block management type [\[NVM001\]](#).

**NVM389:** The NvM module shall provide error recovery on read for every kind of NVRAM block management type by loading of default values.

**NVM390:** The NvM module shall provide error recovery on read for NVRAM blocks of block management type `NVM_BLOCK_REDUNDANT` by loading the redundant NV data with default values.

**NVM168:** The NvM module shall provide error recovery on write by performing write retries regardless of the NVRAM block management type.

**NVM169:** The NvM module shall provide read error recovery on startup for all NVRAM blocks with configured RAM CRC in case of RAM block revalidation failure.

### 7.2.2.7 Recovery of a RAM block with ROM data

**NVM171:** The NvM module shall provide implicit and explicit recovery techniques to restore ROM data to its corresponding RAM block in case of unrecoverable data inconsistency of a NV block [\[NVM387, NVM388\]](#).

Application hint:

As the NvM module does not provide a mechanism or special status information to inform the caller that a ROM block has been loaded due to recovery of a RAM block,

this has to be managed by e.g. SW-Cs itself. A possible solution could be to add additional data marking the block as ROM defaults.

### 7.2.2.8 Implicit recovery of a RAM block with ROM default data

**NVM172:** The implicit recovery shall be provided during startup (part of `NvM_ReadAll`) and `NvM_ReadBlock` for each NVRAM block with a configured ROM block and a permanent RAM block. If permanent RAM block and NV block are invalid or inconsistent, operations shall be performed as specified in the table below. The data content of the corresponding NV block shall remain unmodified.

<i>NVRAM block configured with ROM block</i>	<i>per. RAM block state + CRC</i>	<i>NV block state</i>	<i>read attempt from NV fails</i>	<i>Actions done regarding per. RAM</i>
no	--	--	--	no ROM data loaded
yes	valid + consistent	--	--	no ROM data loaded
yes	invalid + (in)consistent	valid	no	no ROM data loaded
yes	invalid + (in)consistent	valid	yes	ROM data loaded
yes	invalid + (in)consistent	invalid	--	ROM data loaded

### 7.2.2.9 Explicit recovery of a RAM block with ROM default data

**NVM391:** For explicit recovery with ROM block data the NvM module shall provide a function `NvM_RestoreBlockDefaults` [NVM012] to restore ROM data to its corresponding RAM block.

**NVM392:** The function `NvM_RestoreBlockDefaults` shall remain unmodified the data content of the corresponding NV block.

Hint:

The function `NvM_RestoreBlockDefaults` shall be used by the application to restore ROM data to the corresponding RAM block every time it is needed.

#### 7.2.2.10 Detection of an incomplete write operation to a NV block

**NVM174:** The detection of an incomplete write operation to a NV block is out of scope of the NvM module. This is handled and detected by the memory hardware abstraction. The NvM module expects to get information **from** the memory hardware abstraction if a referenced NV block is invalid or inconsistent and cannot be read when requested.

SW-Cs may use `NvM_InvalidateNvBlock` to prevent lower layers from delivering old data.

#### 7.2.2.11 Termination of a single block request

**NVM175:** All asynchronous requests provided by the NvM module (except for `NvM_CancelWriteAll`) shall indicate their result in the designated error/status field of the corresponding Administrative block [\[NVM000\]](#).

**NVM176:** The optional configuration parameter `NvmSingleBlockCallback` configures the notification via callback on the termination of an asynchronous block request (except for `NvM_CancelWriteAll`) [\[NVM061\]](#).

#### 7.2.2.12 Termination of a multi block request

**NVM393:** The NvM module shall use a separate variable to store the result of an asynchronous multi block request (`NvM_ReadAll`, `NvM_WriteAll` including `NvM_CancelWriteAll`).

**NVM394:** The function `NvM_GetErrorStatus` [\[NVM015\]](#) shall return the most recent error/status information of an asynchronous multi block request (including `NvM_CancelWriteAll`) [\[NVM083\]](#) in conjunction with a reserved block ID value of 0.

**NVM395:** The result of a multi block request shall represent only a common error/status information.

**NVM396:** The multi block requests provided by the NvM module shall indicate their detailed error/status information in the designated error/status field of each affected Administrative block.

**NVM179:** The optional configuration parameter `NvmMultiBlockCallback` configures the notification via callback on the termination of an asynchronous multi block request [\[NVM028\]](#).

#### 7.2.2.13 General handling of asynchronous requests/ job processing

**NVM180:** Every time when CRC calculation is processed within a request, the NvM module shall calculate the CRC in multiple steps if the referenced NVRAM block length exceeds the number of bytes configured by the parameter `NvmCrcNumOfBytes`.

**NVM351:** For CRC calculation, the NvM module shall use initial values which are published by the CRC module.

**NVM181:** Multiple concurrent single block requests shall be queueable.

**NVM182:** The NvM module shall interrupt asynchronous request/job processing in favor of jobs with immediate priority (crash data).

**NVM184:** If the invocation of an asynchronous function on the NvM module leads to a job queue overflow, the function shall return with `E_NOT_OK`.

**NVM185:** On successful enqueueing a request, the NvM module shall set the request result of the corresponding NVRAM block to `NVM_REQ_PENDING`.

**NVM270:** If the NvM module has successfully processed a job, it shall return `NVM_REQ_OK` as job result.

### 7.2.2.14 NVRAM block write protection

The NvM module shall offer different kinds of write protection which shall be configurable. Every kind of write protection is only related to the NV part of NVRAM block, i.e. the RAM block data can be modified but not be written to NV memory.

**NVM325:** For enabling and disabling write protection the function `NvM_SetBlockProtection` [NVM016] shall be used which depends on the configuration parameters `NvmBlockWriteProt` and `NvmWriteBlockOnce`.

<i><b>NvM_SetBlockProtection can modify write protection?</b></i>	<i><b>NvmBlockWriteProt</b></i>	<i><b>NvmWriteBlockOnce</b></i>
YES	TRUE	FALSE
YES	FALSE	FALSE
NO	TRUE	TRUE
NO	FALSE	TRUE

**NVM326:** For all NVRAM blocks configured with `NvmBlockWriteProt == TRUE`, the NvM module shall enable a default write protection. The NvM module's environment can explicitly disable the write protection using the `NvM_SetBlockProtection` function.

**NVM397:** For NVRAM blocks configured with `NvmWriteBlockOnce == TRUE` [NVM072], the NvM module shall only write once to the associated NV memory, i.e. in case of a blank NV device.

**NVM398:** For NVRAM blocks configured with `NvmWriteBlockOnce == TRUE`, the NvM module shall not allow disabling the write protection explicitly using the `NvM_SetBlockProtection` function. [NVM276]

**7.2.2.15 Validation and modification of RAM block data**

This chapter shall give summarized information regarding the internal handling of NVRAM Manager status bits. Depending on different API calls, the influence on the status of RAM blocks shall be described in addition to the specification items located in chapter 8.3.

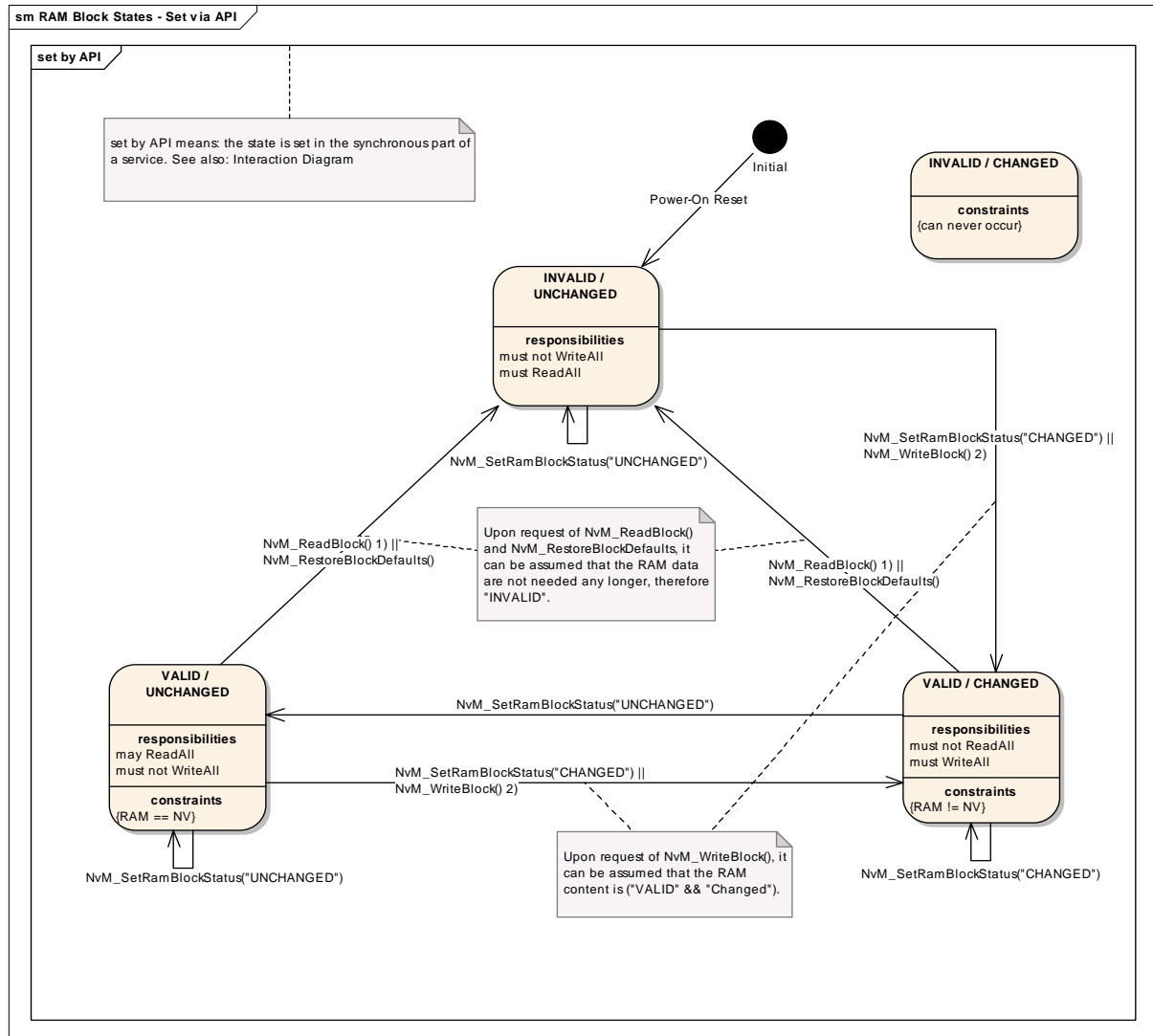

**Figure 8: RAM block states I**

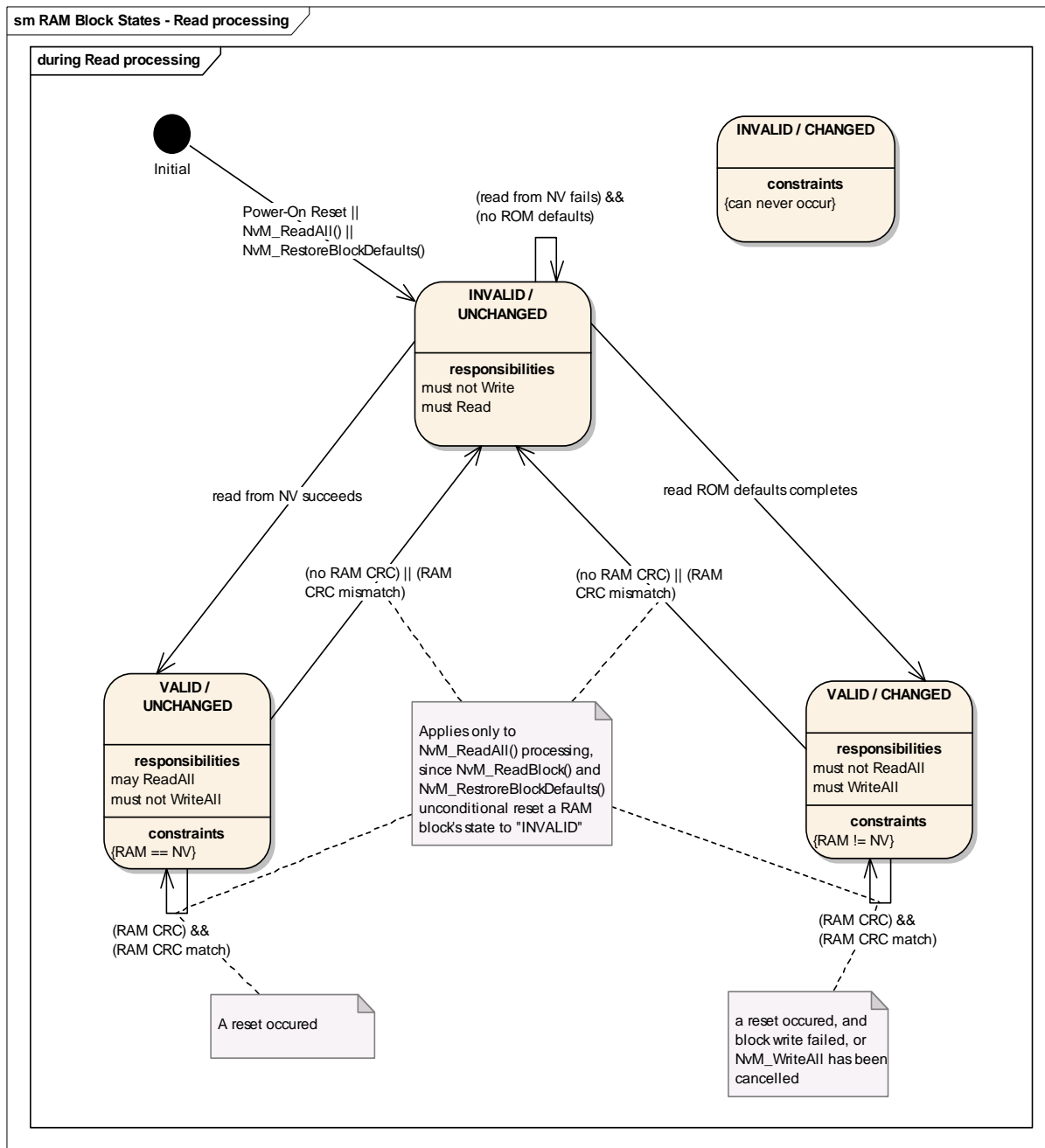

**Figure 9: RAM block states II**

**NVM344:** If the API for modifying the RAM block status has been configured out (via `NvmSetRamBlockStatusApi`) the NvM module shall treat a RAM block as valid and modified when writing to it, i.e. during `NvM_WriteAll`, the NvM module shall write each permanent RAM block to NV memory.

**NVM345:** If the API for modifying the RAM block status has been configured out (via `NvmSetRamBlockStatusApi`) the NvM module shall treat a RAM block as invalid when reading it, i.e. during `NvM_ReadAll`, the NvM module shall copy each NVRAM block to RAM if configured accordingly.

Note: In case of an unsuccessful block read attempt, it is the responsibility of the application to provide valid data before the next write attempt.

### **7.2.2.16 Communication and synchronization between application and NVRAM manager**

To minimize locking/unlocking overhead or the use of other synchronization methods, the communication between applications and the NvM module must follow a strict sequence of steps which is described below. This ensures a reliable communication between applications and the NvM module and avoids data corruption in RAM blocks and a proper synchronization is guaranteed.

This access model assumes that two parties are involved in communication with a RAM block: The application and the NvM module.

If several applications are using the same RAM block it is not the job of the NvM module to ensure the data integrity of the RAM block. In this case, the applications have to synchronize their accesses to the RAM block and have to guarantee that no unsuitable accesses to the RAM block take place during NVRAM operations (details see below).

Especially if several applications are sharing a NVRAM block by using (different) temporary RAM blocks, synchronization between applications becomes more complex and this is not handled by the NvM module, too. In case of using callbacks as notification method, it could happen that e.g. an application gets a notification although the request has not been initiated by this application.

All applications have to adhere to the following rules.

#### **7.2.2.16.1 Write requests (NvM\_WriteBlock)**

1. The application fills a RAM block with the data that has to be written by the NvM module.
2. The application issues the `NvM_WriteBlock` request which transfers control to the NvM module.
3. From now on the application must not modify the RAM block until success or failure of the request is signaled or derived via polling. In the meantime the contents of the RAM block may be read.
4. An application can use polling to get the status of the request or can be informed via a callback function asynchronously.
5. After completion of the NvM module operation, the RAM block is reusable for modifications.



#### **7.2.2.16.2 Read requests (NvM\_ReadBlock)**

1. The application provides a RAM block that has to be filled with NVRAM data from the NvM module's side.
2. The application issues the `NvM_ReadBlock` request which transfers control to the NvM module.
3. From now on the application must not read or write to the RAM block until success or failure of the request is signaled or derived via polling.
4. An application can use polling to get the status of the request or can be informed via a callback function.
5. After completion of the NvM module operation, the RAM block is available with new data for use by the application.

#### **7.2.2.16.3 Restore default requests (NvM\_RestoreBlockDefaults)**

1. The application provides a RAM block, which has to be filled with ROM data from the NvM modules side.
2. The application issues the `NvM_RestoreBlockDefaults` request which transfers control to the NvM module.
3. From now on the application must not read or write to the RAM block until success or failure of the request is signaled or derived via polling.
4. An application can use polling to get the status of the request or can be informed via a callback function.
5. After completion of the NvM module operation, the RAM block is available with the ROM data for use by the application.

#### **7.2.2.16.4 Multi block read requests (NvM\_ReadAll)**

This request may be triggered only by the ECU state manager at system startup. This request fills all configured permanent RAM blocks with necessary data for startup.

If the request fails or the request is handled only partially successful, the NVRAM-Manager signals this condition to the DEM and returns an error to the ECU state manager. The DEM and the ECU state manager have to decide about further measures that have to be taken. These steps are beyond the scope of the NvM module and are handled in the specifications of DEM and ECU state manager.

Normal operation:

1. The ECU state manager issues the `NvM_ReadAll`.
2. The ECU state manager can use polling to get the status of the request or can be informed via a callback function.
3. During `NvM_ReadAll`, a single block callback (if configured) will be invoked after having completely processed a NVRAM block. These callbacks enable the RTE to start each SW-C individually.

#### **7.2.2.16.5 Multi block write requests (`NvM_WriteAll`)**

This request must only be triggered by the ECU state manager at shutdown of the system. This request writes the contents of all modified permanent RAM blocks to NV memory. By calling this request only during ECU shutdown, the ECU state manager can ensure that no SW component is able to modify data in the RAM blocks until the end of the operation. These measures are beyond the scope of the NvM module and are handled in the specifications of the ECU state manager.

Normal operation:

1. The ECU state manager issues the `NvM_WriteAll` request which transfers control to the NvM module.
2. The ECU state manager can use polling to get the status of the request or can be informed via a callback function.

#### **7.2.2.16.6 Cancel Operation (`NvM_CancelWriteAll`)**

This request cancels a pending `NvM_WriteAll` request. This is an asynchronous request and can be called to terminate a pending `NvM_WriteAll` request. This request shall only be used by the ECU state manager.

#### **7.2.2.16.7 Modification of administrative blocks**

For administrative purposes an administrative block is part of each configured NVRAM block (ref. to ch. 7.1.3.4).

If there is a pending single-block operation for a NVRAM block, the application is not allowed to call any operation that modifies the administrative block, like `NvM_SetDataIndex`, `NvM_SetBlockProtection`, `SetRamBlockStatus`, until the pending job has finished.

### 7.2.2.17 Normal and extended runtime preparation of NVRAM blocks

This subchapter is supposed to provide a short summary of normal and extended runtime preparation of NVRAM blocks. The detailed behavior regarding the handling of NVRAM blocks during start-up is specified in chapter 8.3.3.1.

Depending on the two configuration parameters `NvmDynamicConfiguration` and `NvmResistantToChangedSw` the NVRAM Manager shall behave in different ways during start-up, i.e. while processing the request `NvM_ReadAll()`.

If `NvmDynamicConfiguration` is set to `FALSE`, the NVRAM Manager shall ignore the stored configuration ID and continue with the normal runtime preparation of NVRAM blocks. In this case the RAM block shall be checked for its validity. If the RAM block content is detected to be invalid the NV block shall be checked for its validity. A NV block which is detected to be valid shall be copied to its assigned RAM block. If an invalid NV Block is detected default data shall be loaded.

If `NvmDynamicConfiguration` is set to `TRUE` and a configuration ID mismatch is detected, the extended runtime preparation shall be performed for those NVRAM blocks which are configured with `NvmResistantToChangedSw(FALSE)`. In this case default data shall be loaded independent of the validity of an assigned RAM or NV block.

## 7.3 Error classification

**NVM186:** Values for production code Event Ids are assigned externally by the configuration of the Dem. They are published in the file `Dem_IntErrId.h` and included via `Dem.h`.

**NVM187:** Development error values are of type `uint8`.

**NVM023:** The following errors and exceptions shall be detectable by the `NvM` module depending on its build version (development/production mode).

<i>Type or error</i>	<i>Relevance</i>	<i>Related error code</i>	<i>Value[hex]</i>
API requests called with wrong parameter	Development	NVM_E_PARAM_BLOCK_ID NVM_E_PARAM_BLOCK_TYPE NVM_E_PARAM_BLOCK_DATA_IDX NVM_E_PARAM_ADDRESS NVM_E_PARAM_DATA	0x0A 0x0B 0x0C 0x0D 0x0E
NVRAM manager is still not initialized	Development	NVM_E_NOT_INITIALIZED	0x14
API read/write/control request failed because a block with the same ID is already listed or currently in progress	Development	NVM_E_BLOCK_PENDING	0x15
NVRAM manager job queue overflow occurred	Development	NVM_E_LIST_OVERFLOW	0x16
A write attempt to a write protected NVRAM block was requested.	Development	NVM_E_NV_WRITE_PROTECTED	0x17
The service is not possible with this block configuration.	Development	NVM_E_BLOCK_CONFIG	0x18
API request integrity failed	Production	NVM_E_INTEGRITY_FAILED	Assigned by DEM
API request failed	Production	NVM_E_REQ_FAILED	Assigned by DEM

**NVM024:** Additional errors that are detected because of specific implementation and/or specific hardware properties shall be added in the NvM module implementation specification. The classification and enumeration shall be compatible to the errors listed above [\[NVM023\]](#).

## 7.4 Error detection

**NVM025:** The detection of development errors is configurable (*ON / OFF*) at pre-compile time. The switch `NvmDevErrorDetect` (see chapter 10) shall activate or deactivate the detection of all development errors.

**NVM188:** If the `NvmDevErrorDetect` switch is enabled API parameter checking is enabled. The detailed description of the detected errors can be found in chapter 7.3.

**NVM189:** The detection of production code errors cannot be switched off.

**NVM027:** If development error detection is enabled for this module [\[NVM028\]](#), the following table specifies which DET error values shall be reported for each API call:

<b>API call</b>	<b>Error condition</b>	<b>DET related error value</b>
NvM_Init	--	--
NvM_SetDataIndex	NVM not yet initialized	NVM_E_NOT_INITIALIZED
	NVRAM block identifier is already queued or currently in progress	NVM_E_BLOCK_PENDING
	DataIndex parameter exceeds the total number of configured datasets NVM444, NVM445	NVM_E_PARAM_BLOCK_DATA_IDX
	The request is not possible in conjunction with the configured block management type.	NVM_E_PARAM_BLOCK_TYPE
	The passed BlockID is out of range	NVM_E_PARAM_BLOCK_ID
NvM_GetDataIndex	NVM not yet initialized	NVM_E_NOT_INITIALIZED
	The request is not possible in conjunction with the configured block management type.	NVM_E_PARAM_BLOCK_TYPE
	The passed BlockID is out of range	NVM_E_PARAM_BLOCK_ID
	A NULL pointer is passed via the parameter DataIndexPtr.	NVM_E_PARAM_DATA
NvM_SetBlockProtection	NVM not yet initialized	NVM_E_NOT_INITIALIZED
	NVRAM block identifier is already queued or currently in progress	NVM_E_BLOCK_PENDING
	The NVRAM block is configured with NvmWriteBlockOnce = TRUE	NVM_E_BLOCK_CONFIG
	The passed BlockID is out of range	NVM_E_PARAM_BLOCK_ID
NvM_GetErrorStatus	NVM not yet initialized	NVM_E_NOT_INITIALIZED
	The passed BlockID is out of range	NVM_E_PARAM_BLOCK_ID
	A NULL pointer is passed via the parameter RequestResultPtr.	NVM_E_PARAM_DATA
NvM_GetVersionInfo	A NULL pointer is passed via the parameter versioninfo.	NVM_E_PARAM_DATA
NvM_ReadBlock	NVM not yet initialized	NVM_E_NOT_INITIALIZED
	NVRAM block identifier is already queued or currently in progress	NVM_E_BLOCK_PENDING
	No permanent RAM block is configured and a NULL pointer is passed via the parameter NvM_DstPtr.	NVM_E_PARAM_ADDRESS
	A job queue overflow occurred	NVM_E_LIST_OVERFLOW
	The passed BlockID is out of range	NVM_E_PARAM_BLOCK_ID
NvM_WriteBlock	NVM not yet initialized	NVM_E_NOT_INITIALIZED
	NVRAM block identifier is already queued or currently in progress	NVM_E_BLOCK_PENDING
	A job queue overflow occurred	NVM_E_LIST_OVERFLOW
	No permanent RAM block is configured and a NULL pointer is passed via the parameter NvM_SrcPtr	NVM_E_PARAM_ADDRESS
	A write protected NVRAM block is referenced by the passed BlockID.	NVM_E_NV_WRITE_PROTECTED
	The passed BlockID is out of range	NVM_E_PARAM_BLOCK_ID

NvM_RestoreBlockDefaults	NVM not yet initialized	NVM_E_NOT_INITIALIZED
	NVRAM block identifier is already queued or currently in progress	NVM_E_BLOCK_PENDING
	A job queue overflow occurred	NVM_E_LIST_OVERFLOW
	Default data is not available/configured for the referenced NVRAM block.	NVM_E_BLOCK_CONFIG
	No permanent RAM block is configured and a NULL pointer is passed via the parameter NvM_DstPtr	NVM_E_PARAM_ADDRESS
	The passed BlockID is out of range	NVM_E_PARAM_BLOCK_ID
NvM_EraseNvBlock	NVM not yet initialized	NVM_E_NOT_INITIALIZED
	NVRAM block identifier is already queued or currently in progress	NVM_E_BLOCK_PENDING
	A job queue overflow occurred	NVM_E_LIST_OVERFLOW
	A write protected NVRAM block is referenced by the passed BlockID.	NVM_E_NV_WRITE_PROTECTED
	The passed BlockID is out of range	NVM_E_PARAM_BLOCK_ID
	The NVRAM block has not immediate priority	NVM_E_BLOCK_CONFIG
NvM_CancelWriteAll	NVM not yet initialized	NVM_E_NOT_INITIALIZED
NvM_InvalidateNvBlock	NVM not yet initialized	NVM_E_NOT_INITIALIZED
	NVRAM block identifier is already queued or currently in progress	NVM_E_BLOCK_PENDING
	A job queue overflow occurred	NVM_E_LIST_OVERFLOW
	A write protected NVRAM block is referenced by the passed BlockID.	NVM_E_NV_WRITE_PROTECTED
	The passed BlockID is out of range	NVM_E_PARAM_BLOCK_ID
NvM_SetRamBlockStatus	NVM not yet initialized	NVM_E_NOT_INITIALIZED
	NVRAM block identifier is already queued or currently in progress	NVM_E_BLOCK_PENDING
	The passed BlockID is out of range	NVM_E_PARAM_BLOCK_ID
NvM_ReadAll	NVM not yet initialized	NVM_E_NOT_INITIALIZED
NvM_WriteAll	NVM not yet initialized	NVM_E_NOT_INITIALIZED

## 7.5 Error notification

**NVM026:** Production errors shall be reported to the Diagnostic Event Manager.

**NVM191:** Detected development errors shall be reported to the `Det_ReportError` service of the Development Error Tracer (DET) if the pre-processor switch `PWM_DEV_ERROR_DETECT` is set (see chapter 10).

## 7.6 Version check

**NVM089:** `NvM.c` shall check if the correct version of `NvM.h` is included. This shall be done by a preprocessor check of the version number `NVM_SW_MAJOR_VERSION` [[NVM022](#)].

## 8 API specification

### 8.1 Imported types

In this chapter all types included from the following files are listed:

#### NVM446:

Header file	Imported Type
Memlf_Types.h	Memlf_ModeType
	Memlf_JobResultType
	Memlf_StatusType
Dem_Types.h	Dem_EventIdType
Std_Types.h	Std_VersionInfoType
	Std_ReturnType

### 8.2 Type definitions

#### 8.2.1 NvM\_RequestResultType

**NVM083:** The type NvM\_RequestResultType is an asynchronous request result, which will be returned by the API service NvM\_GetErrorStatus [NVM015].

#### NVM470:

<b>Name:</b>	NvM_RequestResultType	
<b>Type:</b>	uint8	
<b>Range:</b>	NVM_REQ_OK	0 The last asynchronous read/write/control request has been finished successfully. This shall be the default value after reset. This status shall have the value 0.
	NVM_REQ_NOT_OK	1 The last asynchronous read/write/control request has been finished unsuccessfully.
	NVM_REQ_PENDING	2 An asynchronous read/write/control request is currently pending.
	NVM_REQ_INTEGRITY_FAILED	3 The result of the last asynchronous request NvM_ReadBlock or NvM_ReadAll is a data integrity failure.  Note: In case of NvM_ReadBlock the content of the RAM block has changed but has become invalid. The application is responsible to renew and validate the RAM block content.

	NVM_REQ_BLOCK_SKIPPED	4	The referenced block was skipped during execution of NvM_ReadAll or NvM_WriteAll, e.g. Dataset NVRAM blocks (NvM_ReadAll) or NVRAM blocks without a permanently configured RAM block.
	NVM_REQ_NV_INVALIDATED	5	The referenced NV block is invalidated.
	NVM_REQ_CANCELLED	6	The multi block request NvM_WriteAll was cancelled by calling NvM_CancelWriteAll.
<b>Description:</b>	This is an asynchronous request result returned by the API service NvM_GetErrorStatus. The availability of an asynchronous request result can be additionally signaled via a callback function.		

## 8.2.2 NvM\_BlockIdType

### NVM471:

<b>Name:</b>	NvM_BlockIdType	
<b>Type:</b>	uint16	
<b>Range:</b>	0..2 <sup>(16-NVM_DATASET_SELECTION_BITS)</sup> -1	--
<b>Description:</b>	Identification of a NVRAM block via a unique block identifier.  Reserved NVRAM block IDs: 0 -> to derive multi block request results via NvM_GetErrorStatus 1 -> redundant NVRAM block which holds the configuration ID	

**NVM475:** The NVRAM block IDs are expected to be in a sequential order, i.e. the NVRAM manager does not need to be capable of handling non-sequential NVRAM block IDs.



## 8.3 Function definitions

### 8.3.1 Synchronous requests

#### 8.3.1.1 NvM\_Init

##### NVM447:

<b>Service name:</b>	NvM_Init
<b>Syntax:</b>	void NvM_Init(  )
<b>Service ID[hex]:</b>	0x00
<b>Sync/Async:</b>	Synchronous
<b>Reentrancy:</b>	Non Reentrant
<b>Parameters (in):</b>	None
<b>Parameters (inout):</b>	None
<b>Parameters (out):</b>	None
<b>Return value:</b>	None
<b>Description:</b>	Service for resetting all internal variables.

**NVM399:** The function `NvM_Init` shall reset all internal variables, e.g. the queues, request flags, state machines, to their initial values. It shall signal “INIT DONE” internally, e.g. to enable job processing and queue management.

**NVM400:** The function `NvM_Init` shall not modify the permanent RAM block contents, as this shall be done on `NvM_ReadAll`.

**NVM192:** The function `NvM_Init` shall set the dataset index of all NVRAM blocks of type `NVM_BLOCK_DATASET` to zero.

**NVM193:** The function `NvM_Init` shall not initialize other modules (it is assumed that the underlying layers are already initialized).

The function `NvM_Init` is affected by the common [\[NVM028\]](#) and published [\[NVM022\]](#) configuration parameter.

Hint:

The time consuming NVRAM block initialization and setup according to the block descriptor [\[NVM061\]](#) shall be done by the `NvM_ReadAll` request [\[NVM008\]](#).

#### 8.3.1.2 NvM\_SetDataIndex

##### NVM448:

<b>Service name:</b>	NvM_SetDataIndex	
<b>Syntax:</b>	<pre>void NvM_SetDataIndex(     NvM_BlockIdType BlockId,     uint8 DataIndex )</pre>	
<b>Service ID[hex]:</b>	0x01	
<b>Sync/Async:</b>	Synchronous	
<b>Reentrancy:</b>	Reentrant	
<b>Parameters (in):</b>	BlockId	The block identifier uniquely identifies one NVRAM block descriptor. A NVRAM block descriptor contains all needed information about a single NVRAM block.
	DataIndex	Index position (association) of a NV/ROM block.
<b>Parameters (inout):</b>	None	
<b>Parameters (out):</b>	None	
<b>Return value:</b>	None	
<b>Description:</b>	Service for setting the DataIndex of a dataset NVRAM block.	

**NVM014:** The function `NvM_SetDataIndex` shall set the index to access a certain dataset of a NVRAM block (with/without ROM blocks).

**NVM263:** The function `NvM_SetDataIndex` shall leave the content of the corresponding RAM block unmodified.

**NVM264:** The NvM module's environment shall use the function `NvM_SetDataIndex` in conjunction with dataset NVRAM block management types. The function `NvM_SetDataIndex` shall be able to be used in conjunction with all other block management types but without any effect in production mode.

Regarding error detection, the requirement [NVM027](#) is applicable to the function `NvM_SetDataIndex`.

**NVM401:** The NvM module's environment shall have initialized the NvM module before it calls the function `NvM_SetDataIndex`.

Hint:

NVRAM common block configuration parameters [\[NVM028\]](#), block management types [\[NVM061\]](#) and one configured NVRAM block descriptor needed [\[NVM062\]](#).

### 8.3.1.3 NvM\_GetDataIndex

#### NVM449:

<b>Service name:</b>	NvM_GetDataIndex
<b>Syntax:</b>	void NvM_GetDataIndex( NvM_BlockIdType BlockId, uint8* DataIndexPtr )
<b>Service ID[hex]:</b>	0x02
<b>Sync/Async:</b>	Synchronous
<b>Reentrancy:</b>	Reentrant
<b>Parameters (in):</b>	BlockId      The block identifier uniquely identifies one NVRAM block descriptor. A NVRAM block descriptor contains all needed information about a single NVRAM block.
<b>Parameters (inout):</b>	None
<b>Parameters (out):</b>	DataIndexPtrPointer to where to store the current dataset index (0..255)
<b>Return value:</b>	None
<b>Description:</b>	Service for getting the currently set DataIndex of a dataset NVRAM block

**NVM021:** The function `NvM_GetDataIndex` shall get the current index (association) of a dataset NVRAM block (with/without ROM blocks).

**NVM265:** The function `NvM_GetDataIndex` shall be able to be used in conjunction with all other block management types than dataset block management type is possible but without any effect in production mode. In this case, the function shall return zero, i.e. the function shall set the pointer `DataIndexPtr` to zero.

Regarding error detection, the requirement [NVM027](#) is applicable to the function `NvM_GetDataIndex`.

**NVM402:** The NvM module's environment shall have initialized the NvM module before it calls the function `NvM_GetDataIndex`.

Hint:

NVRAM common block configuration parameters [\[NVM028\]](#), block management types [\[NVM061\]](#) and one configured NVRAM block descriptor needed [\[NVM062\]](#).

### 8.3.1.4 NvM\_SetBlockProtection

#### NVM450:

<b>Service name:</b>	NvM_SetBlockProtection
<b>Syntax:</b>	void NvM_SetBlockProtection( NvM_BlockIdType BlockId, boolean ProtectionEnabled )
<b>Service ID[hex]:</b>	0x03
<b>Sync/Async:</b>	Synchronous

<b>Reentrancy:</b>	Reentrant	
<b>Parameters (in):</b>	BlockId	The block identifier uniquely identifies one NVRAM block descriptor. A NVRAM block descriptor contains all needed information about a single NVRAM block.
	ProtectionEnabled	TRUE: Write protection shall be enabled FALSE: Write protection shall be disabled
<b>Parameters (inout):</b>	None	
<b>Parameters (out):</b>	None	
<b>Return value:</b>	None	
<b>Description:</b>	Service for setting/resetting the write protection for a NV block.	

**NVM016:** The function `NvM_SetBlockProtection` shall set/reset the write protection for the corresponding NV block by setting the write protection attribute in the administrative part of the corresponding NVRAM block.

**NVM276:** The function `NvM_SetBlockProtection` shall not change the write protection of NV blocks with `NvmWriteBlockOnce == TRUE`.

Regarding error detection, the requirement [NVM027](#) is applicable to the function `NvM_SetBlockProtection`.

**NVM403:** The NvM module's environment shall have initialized the NvM module before it calls the function `NvM_SetBlockProtection`.

Hint:

NVRAM common block configuration parameters [\[NVM028\]](#), block management types [\[NVM061\]](#) and one configured NVRAM block descriptor needed [\[NVM062\]](#).

### 8.3.1.5 NvM\_GetErrorStatus

**NVM451:**

<b>Service name:</b>	NvM_GetErrorStatus	
<b>Syntax:</b>	<pre>void NvM_GetErrorStatus(     NvM_BlockIdType BlockId,     uint8* RequestResultPtr )</pre>	
<b>Service ID[hex]:</b>	0x04	
<b>Sync/Async:</b>	Synchronous	
<b>Reentrancy:</b>	Reentrant	
<b>Parameters (in):</b>	BlockId	The block identifier uniquely identifies one NVRAM block descriptor. A NVRAM block descriptor contains all needed information about a single NVRAM block.
	None	
<b>Parameters (inout):</b>	None	
<b>Parameters (out):</b>	RequestResultPtr	Pointer to where to store the request result. See <code>NvM_RequestResultType</code> .
<b>Return value:</b>	None	
<b>Description:</b>	Service to read the block dependent error/status information.	

**NVM015:** The function `NvM_GetErrorStatus` shall read the block dependent error/status information in the administrative part of a NVRAM block.

The status/error information of a NVRAM block shall be set by a former or current asynchronous request.

Regarding error detection, the requirement [NVM027](#) is applicable to the function `NvM_GetErrorStatus`.

**NVM404:** The NvM module's environment shall have initialized the NvM module before it calls the function `NvM_GetErrorStatus`.

NVRAM common block configuration parameters [\[NVM028\]](#), block management types [\[NVM061\]](#) and one configured NVRAM block descriptor are needed in the configuration with respect to the function `NvM_GetErrorStatus` [\[NVM062\]](#).

### 8.3.1.6 NvM\_GetVersionInfo

**NVM452:**

<b>Service name:</b>	NvM_GetVersionInfo	
<b>Syntax:</b>	<pre>void NvM_GetVersionInfo(     Std_VersionInfoType* versioninfo )</pre>	
<b>Service ID[hex]:</b>	0x0f	
<b>Sync/Async:</b>	Synchronous	
<b>Reentrancy:</b>	Non Reentrant	
<b>Parameters (in):</b>	None	
<b>Parameters (inout):</b>	None	
<b>Parameters (out):</b>	versioninfo	Pointer to where to store the version information of this module.
<b>Return value:</b>	None	
<b>Description:</b>	Service to get the version information of the NvM module.	

**NVM285:** The function `NvM_GetVersionInfo` shall return the version information of this module. The version information includes:

- Module Id
- Vendor Id
- Vendor specific version numbers (BSW00407).

**NVM286:** The function `NvM_GetVersionInfo` shall be pre-compile time configurable On/Off by the configuration parameter: `NvmVersionInfoApi`

Hint:

If source code for caller and callee of the function `NvM_GetVersionInfo` is available, the function should be realized as a macro. The macro should be defined in the modules header file.

The function `NvM_GetVersionInfo` is affected by the common block configuration parameter `[NVM028]`.

### 8.3.1.7 NvM\_SetRamBlockStatus

#### NVM453:

<b>Service name:</b>	NvM_SetRamBlockStatus	
<b>Syntax:</b>	<pre>void NvM_SetRamBlockStatus(     NvM_BlockIdType BlockId,     boolean BlockChanged )</pre>	
<b>Service ID[hex]:</b>	0x05	
<b>Sync/Async:</b>	Synchronous	
<b>Reentrancy:</b>	Reentrant	
<b>Parameters (in):</b>	BlockId	The block identifier uniquely identifies one NVRAM block descriptor. A NVRAM block descriptor contains all needed information about a single NVRAM block.
	BlockChanged	TRUE: Validate the RAM block and mark block as changed. FALSE: Invalidate the RAM block and mark block as unchanged.
<b>Parameters (inout):</b>	None	
<b>Parameters (out):</b>	None	
<b>Return value:</b>	None	
<b>Description:</b>	Service for setting the RAM block status of an NVRAM block.	

**NVM240:** The function `NvM_SetRamBlockStatus` shall only work on NVRAM blocks with a permanently configured RAM block and shall have no effect to other NVRAM blocks.

**NVM241:** The function `NvM_SetRamBlockStatus` shall assume that a changed permanent RAM block is valid (basic assumption).

**NVM405:** When the “BlockChanged” parameter passed to the function `NvM_SetRamBlockStatus` is FALSE the corresponding RAM block is either invalid or unchanged (or both).

**NVM406:** When the “BlockChanged” parameter passed to the function `NvM_SetRamBlockStatus` is TRUE, the corresponding permanent RAM block is valid and changed.

**NVM121:** The function `NvM_SetRamBlockStatus` shall request the recalculation of CRC in the background, i.e. the CRC recalculation shall be processed by the `NvM_MainFunction`, if the given “BlockChanged” parameter is TRUE and CRC calculation in RAM is configured (i.e. `NvmCalcRamBlockCrc == TRUE`).

#### Hint:

In some cases, a permanent RAM block cannot be validated neither by a reload of its NV data, nor by a load of its ROM data during the execution of a `NvM_ReadAll` command (startup). The application is responsible to fill in proper data to the RAM

block and to validate the block via the function `NvM_SetRamBlockStatus` before this RAM block can be written to its corresponding NV block by `NvM_WriteAll`.

It is expected that the function `NvM_SetRamBlockStatus` will be called frequently for NVRAM blocks which are configured to be protected in RAM via CRC. Otherwise this function only needs to be called once to mark a block as “changed” and to be processed during `NvM_WriteAll`.

Regarding error detection, the requirement [NVM027](#) is applicable to the function `NvM_SetRamBlockStatus`.

**NVM407:** The NvM module’s environment shall have initialized the NvM module before it calls the function `NvM_SetRamBlockStatus`.

**NVM408:** The NvM module shall provide the function `NvM_SetRamBlockStatus` only if it is configured via `NvmSetRamBlockStatusApi` [\[NVM028\]](#).

NVRAM common configuration parameters [\[NVM028\]](#), block management types [\[NVM061\]](#) and one configured NVRAM block descriptor are needed in the configuration with respect to the function `NvM_SetRamBlockStatus` [\[NVM062\]](#).

## 8.3.2 Asynchronous single block requests

### 8.3.2.1 NvM\_ReadBlock

**NVM454:**

<b>Service name:</b>	NvM_ReadBlock	
<b>Syntax:</b>	<pre>Std_ReturnType NvM_ReadBlock(     NvM_BlockIdType BlockId,     uint8* NvM_DstPtr )</pre>	
<b>Service ID[hex]:</b>	0x06	
<b>Sync/Async:</b>	Asynchronous	
<b>Reentrancy:</b>	Reentrant	
<b>Parameters (in):</b>	BlockId	The block identifier uniquely identifies one NVRAM block descriptor. A NVRAM block descriptor contains all needed information about a single NVRAM block.
<b>Parameters (inout):</b>	None	
<b>Parameters (out):</b>	NvM_DstPtr	Pointer to the RAM data block.
<b>Return value:</b>	Std_ReturnType	E_OK: request has been accepted E_NOT_OK: request has not been accepted
<b>Description:</b>	Service to copy the data of the NV block to its corresponding RAM block.	

**NVM010:** The job of the function `NvM_ReadBlock` shall copy the data of the NV block to the corresponding RAM block.

**NVM195:** The function `NvM_ReadBlock` shall take over the given parameters, queue the read request in the job queue and return.

**NVM196:** The NvM module's environment shall pass a NULL pointer or the address of the permanent RAM block via the parameter `NvM_DstPtr` if the referenced RAM block is configured to be permanent available.

**NVM278:** The job of the function `NvM_ReadBlock` shall provide the possibility to copy NV data to a temporary RAM block although the NVRAM block is configured with a permanent RAM block. In this case, the parameter `NvM_DstPtr` must be unequal to the NULL pointer.

**NVM198:** The function `NvM_ReadBlock` shall invalidate a permanent RAM block immediately when the block is successfully enqueued or the job processing starts, i.e. copying data from NV memory or ROM to RAM.

**[NVM199:** The job of the function `NvM_ReadBlock` shall initiate a read attempt on the second NV block if the passed `BlockId` references a NVRAM block of type `NVM_BLOCK_REDUNDANT` and the read attempt on the first NV block fails.

**NVM340:** In case of NVRAM block management type `NVM_BLOCK_DATASET`, the job of the function `NvM_ReadBlock` shall copy only that NV block to the corresponding RAM block which is selected via the data index in the administrative block.

**NVM355:** The job of the function `NvM_ReadBlock` shall not copy the NV block to the corresponding RAM block if the NVRAM block management type is `NVM_BLOCK_DATASET` and the NV block selected by the dataset index is invalidate or inconsistent.

**NVM354:** The job of the function `NvM_ReadBlock` shall copy the ROM block to RAM and set the job result to `NVM_REQ_OK` if the NVRAM block management type is `NVM_BLOCK_DATASET` and the dataset index points at a ROM block.

**NVM200:** The job of the function `NvM_ReadBlock` shall set the RAM block to valid and assume it to be unchanged after a successful copy process of the NV block to RAM.

**NVM366:** The job of the function `NvM_ReadBlock` shall set the RAM block to valid and assume it to be changed if the default values are copied to the RAM successfully.

**NVM206:** The job of the function `NvM_ReadBlock` shall set the job result to `NVM_REQ_OK` if the NV block was copied successfully from NV memory to RAM.

**NVM341:** The job of the function `NvM_ReadBlock` shall set the request result to `NVM_REQ_NV_INVALIDATED` and shall report no error to the DEM if the `MemIf` reports `MEMIF_BLOCK_INVALID`.



**NVM358:** The job of the function `NvM_ReadBlock` shall set the request result to `NVM_REQ_INTEGRITY_FAILED` and report `NVM_E_INTEGRITY_FAILED` to the DEM if the MemIf reports `MEMIF_BLOCK_INCONSISTENT`.

**NVM359:** The job of the function `NvM_ReadBlock` shall set the request result to `NVM_REQ_NOT_OK` and report `NVM_E_REQ_FAILED` to the DEM if the MemIf reports `MEMIF_JOB_FAILED`.

**NVM279:** The job of the function `NvM_ReadBlock` shall set the job result to `NVM_REQ_OK` and report no error to the DEM if the block management type of the given NVRAM block is `NVM_BLOCK_REDUNDANT` and one of the NV blocks was copied successfully from NV memory to RAM.

**NVM316:** The job of the function `NvM_ReadBlock` shall mark every NVRAM block that is not detected by underlying SW as being invalidated and that has been configured with `NvmWriteBlockOnce == TRUE` as write protected.

Hint: This write protection must not be cleared by `NvM_SetBlockProtection`.

**NVM317:** The job of the function `NvM_ReadBlock` shall invalidate a NVRAM block of management type redundant if both NV blocks have been invalidated.

**NVM201:** The job of the function `NvM_ReadBlock` shall request a CRC recalculation over the RAM block data after the copy process [NVM180] if the NV block is configured with CRC.

**NVM202:** The job of the function `NvM_ReadBlock` shall load the default values according to processing of `NvM_RestoreBlockDefaults` if the recalculated CRC is not equal to the CRC stored in NV memory or the read request passed to the underlying layer fails. If there are no default values available, the RAM blocks shall remain invalid.

**NVM203:** The job of the function `NvM_ReadBlock` shall report `NVM_E_INTEGRITY_FAILED` to the DEM if a CRC mismatch occurs.

**NVM204:** The job of the function `NvM_ReadBlock` shall set the job result `NVM_REQ_INTEGRITY_FAILED` if a CRC mismatch occurs.

Regarding error detection, the requirement NVM027 is applicable to the function `NvM_ReadBlock`.

**NVM409:** The NvM module's environment shall have initialized the NvM module before it calls the function `NvM_ReadBlock`.

NVRAM common block configuration parameters [NVM028], block management types [NVM061] and one configured NVRAM block descriptor are needed for configuration with respected to the function `NvM_ReadBlock` [NVM062].

### 8.3.2.2 NvM\_WriteBlock

#### NVM455:

<b>Service name:</b>	NvM_WriteBlock	
<b>Syntax:</b>	<pre>Std_ReturnType NvM_WriteBlock(     NvM_BlockIdType BlockId,     const uint8* NvM_SrcPtr )</pre>	
<b>Service ID[hex]:</b>	0x07	
<b>Sync/Async:</b>	Asynchronous	
<b>Reentrancy:</b>	Reentrant	
<b>Parameters (in):</b>	BlockId	The block identifier uniquely identifies one NVRAM block descriptor. A NVRAM block descriptor contains all needed information about a single NVRAM block.
	NvM_SrcPtr	Pointer to the RAM data block.
<b>Parameters (inout):</b>	None	
<b>Parameters (out):</b>	None	
<b>Return value:</b>	Std_ReturnType	E_OK: request has been accepted E_NOT_OK: request has not been accepted
<b>Description:</b>	Service to copy the data of the RAM block to its corresponding NV block.	

**NVM410:** The job of the function `NvM_WriteBlock` shall copy the data of the RAM block to its corresponding NV block.

**NVM411:** The function `NvM_WriteBlock` shall test the write protection attribute of the NV block in the administrative part of the corresponding RAM block.

**NVM217:** The function `NvM_WriteBlock` shall return with `E_NOT_OK`, if a write protected NVRAM block is referenced by the passed `BlockId` parameter.

**NVM208:** The function `NvM_WriteBlock` shall take over the given parameters, queue the write request in the job queue and return.

**NVM209:** The function `NvM_WriteBlock` shall check the NVRAM block protection when the request is enqueued but not again before the request is executed.

**NVM300:** The function `NvM_WriteBlock` shall cancel a pending job immediately in a destructive way if the passed `BlockId` references a NVRAM block configured to have immediate priority. The immediate job shall be the next active job to be processed.

**NVM210:** The NvM module's environment shall pass a NULL pointer or the address of a permanent RAM block as parameter `NvM_SrcPtr` to the function `NvM_WriteBlock` if the referenced RAM block is configured to be permanent available.

**NVM280:** The job of the function `NvM_WriteBlock` shall provide the possibility to copy a temporary RAM block to a NV block although the NVRAM block is configured with a permanent RAM block. In this case, the parameter `NvM_SrcPtr` must be unequal to a NULL pointer.

**NVM212:** The job of the function `NvM_WriteBlock` shall request a CRC recalculation before the RAM block will be copied to NV memory if the NV block is configured with CRC [[NVM180](#)].

**NVM338:** The job of the function `NvM_WriteBlock` shall copy the RAM block to the corresponding NV block which is selected via the data index in the administrative block if the NVRAM block management type of the given NVRAM block is `NVM_BLOCK_DATASET`.

**NVM303:** The job of the function `NvM_WriteBlock` shall assume a referenced permanent RAM block to be valid when the request is passed to the NvM module. If the permanent RAM block is still in an invalid state, the function `NvM_WriteBlock` shall validate it automatically before copying the RAM block contents to NV memory.

**NVM213:** The job of the function `NvM_WriteBlock` shall check the number of write retries using a write retry counter to avoid infinite loops. Each negative result reported by the memory interface shall be followed by an increment of the retry counter. In case of a retry counter overrun, the job of the function `NvM_WriteBlock` shall set the job result to `NVM_REQ_NOT_OK` and report `NVM_E_REQ_FAILED` to the DEM.

**NVM216:** The configuration parameter `NVM_MAX_NO_OF_WRITE_RETRIES` [[NVM028](#)] shall prescribe the maximum number of write retries for the job of the function `NvM_WriteBlock` when RAM block data cannot be written successfully to the corresponding NV block.

**NVM472:** In case of a RAM block is successfully copied to NV memory the RAM block state shall be set to "valid/unmodified" afterwards.

**NVM284:** The job of the function `NvM_WriteBlock` shall set `NVM_REQ_OK` as job result if the passed `BlockId` references a NVRAM block of type `NVM_BLOCK_REDUNDANT` and one of the NV blocks have been written successfully.

**NVM328:** The job of the function `NvM_WriteBlock` shall set the write protection flag in the administrative block immediately if the NVRAM block is configured with `NvMWriteBlockOnce == TRUE` and the data has been written successfully to the NV block.

Regarding error detection, the requirement [NVM027](#) is applicable to the function `NvM_WriteBlock`.

**NVM412:** The NvM module's environment shall have initialized the NvM module before it calls the function `NvM_WriteBlock`.

Hint:

To avoid the situation that in case of redundant NVRAM blocks two different NV blocks are containing different but valid data at the same time, each client of the function `NvM_WriteBlock` may call `NvM_InvalidateNvBlock` in advance.

NVRAM common block configuration parameters [NVM028], block management types [NVM061] and one configured NVRAM block descriptor are needed in the configuration with respect to the function `NvM_WriteBlock` [NVM062].

### 8.3.2.3 NvM\_RestoreBlockDefaults

**NVM456:**

<b>Service name:</b>	NvM_RestoreBlockDefaults	
<b>Syntax:</b>	<pre>Std_ReturnType NvM_RestoreBlockDefaults(     NvM_BlockIdType BlockId,     uint8* NvM_DestPtr )</pre>	
<b>Service ID[hex]:</b>	0x08	
<b>Sync/Async:</b>	Asynchronous	
<b>Reentrancy:</b>	Non Reentrant	
<b>Parameters (in):</b>	BlockId	The block identifier uniquely identifies one NVRAM block descriptor. A NVRAM block descriptor contains all needed information about a single NVRAM block.
<b>Parameters (inout):</b>	None	
<b>Parameters (out):</b>	NvM_DestPtr	Pointer to the RAM data block.
<b>Return value:</b>	Std_ReturnType	E_OK: request has been accepted E_NOT_OK: request has not been accepted
<b>Description:</b>	Service to restore the default data to its corresponding RAM block.	

**NVM012:** The job of the function `NvM_RestoreBlockDefaults` shall restore the default data to its corresponding RAM block.

**NVM224:** The function `NvM_RestoreBlockDefaults` shall take over the given parameters, queue the request in the job queue and return.

**NVM267:** The job of the function `NvM_RestoreBlockDefaults` shall load the default data from a ROM block if a ROM block is configured.

**NVM266:** The NvM module's environment shall call the function `NvM_RestoreBlockDefaults` to obtain the default data if no ROM block is configured for a NVRAM block and an application callback routine is configured via the parameter `NvmInitBlockCallback`.

**NVM353:** The function `NvM_RestoreBlockDefaults` shall return with `E_NOT_OK` if the block management type of the given NVRAM block is `NVM_BLOCK_DATASET`, at least one ROM block is configured and the data index points at a NV block.

**NVM435:** The NvM module's environment shall pass a `NULL` pointer via the parameter `NvM_DstPtr` to the function `NvM_RestoreBlockDefaults` if the referenced RAM block is configured to be permanent available

**NVM436:** The NvM module's environment shall pass a pointer unequal to `NULL` via the parameter `NvM_DstPtr` to the function `NvM_RestoreBlockDefaults` in order to copy ROM data to a temporary RAM block although the NVRAM block is configured with a permanent RAM block.

**NVM227:** The job of the function `NvM_RestoreBlockDefaults` shall invalidate a RAM block before copying default data to the RAM if a permanent RAM block is requested.

**NVM228:** The job of the function `NvM_RestoreBlockDefaults` shall validate and assume a RAM block to be changed if the requested RAM block is permanent and the copy process of the default data to RAM was successful.

**NVM229:** The job of the function `NvM_RestoreBlockDefaults` shall request a recalculation of CRC from a RAM block after the copy process/validation if a CRC is configured for this RAM block.

Regarding error detection, the requirement [NVM027](#) is applicable to the function `NvM_RestoreBlockDefaults`.

**NVM413:** The NvM module's environment shall have initialized the NvM module before it calls the function `NvM_RestoreBlockDefaults`.

Hint:

For the block management type `NVM_BLOCK_DATASET`, the application has to ensure that a valid dataset index is selected (pointing to ROM data).

NVRAM common block configuration parameters [\[NVM028\]](#), block management types [\[NVM061\]](#) and one configured NVRAM block descriptor are needed in the configuration with respect to the function `NvM_RestoreBlockDefaults` [\[NVM062\]](#).

### 8.3.2.4 NvM\_EraseNvBlock

#### NVM457:

<b>Service name:</b>	NvM_EraseNvBlock	
<b>Syntax:</b>	Std_ReturnType NvM_EraseNvBlock( NvM_BlockIdType BlockId )	
<b>Service ID[hex]:</b>	0x09	
<b>Sync/Async:</b>	Asynchronous	
<b>Reentrancy:</b>	Reentrant	
<b>Parameters (in):</b>	BlockId	The block identifier uniquely identifies one NVRAM block descriptor. A NVRAM block descriptor contains all needed information about a single NVRAM block.
<b>Parameters (inout):</b>	None	
<b>Parameters (out):</b>	None	
<b>Return value:</b>	Std_ReturnType	E_OK: request has been accepted E_NOT_OK: request has not been accepted
<b>Description:</b>	Service to erase a NV block.	

**NVM415:** The job of the function `NvM_EraseNvBlock` shall erase a NV block.

**NVM231:** The function `NvM_EraseNvBlock` shall take over the given parameters, queue the request and return.

**NVM418:** The function `NvM_EraseNvBlock` shall queue the request to erase in case of disabled write protection.

**NVM416:** The job of the function `NvM_EraseNvBlock` shall leave the content of the RAM block unmodified.

**NVM417:** The function `NvM_EraseNvBlock` shall test the write protection attribute of the NV block in the corresponding Administrative block.

**NVM262:** The function `NvM_EraseNvBlock` shall return with `E_NOT_OK` if a write protected NV block or a ROM block of a dataset NVRAM block is referenced.

**NVM230:** The function `NvM_EraseNvBlock` shall check the write protection of a NVRAM block only before the job is put to the job queue. The NvM module shall not re-check the write protection before fetching the job from the job queue.

**NVM269:** If the referenced NVRAM block is of type `NVM_BLOCK_REDUNDANT`, the function `NvM_EraseNvBlock` shall only succeed when both NV blocks have been erased.

**NVM271:** The job of the function `NvM_EraseNvBlock` shall set the job result to `NVM_REQ_NOT_OK` and report `NVM_E_REQ_FAILED` to the DEM if the processing of the service fails.

**NVM357:** The function `NvM_EraseNvBlock` shall return with `E_NOT_OK`, when development error detection is enabled and the referenced NVRAM block is configured with standard priority.

Regarding error detection, the requirement [NVM027](#) is applicable to the function `NvM_EraseNvBlock`.

**NVM414:** The NvM module's environment shall have initialized the NvM module before it calls the function `NvM_EraseNvBlock`.

NVRAM common block configuration parameters [\[NVM028\]](#), block management types [\[NVM061\]](#) and one configured NVRAM block descriptor are needed in the configuration with respect to the function `NvM_EraseNvBlock` [\[NVM062\]](#).

### 8.3.2.5 NvM\_CancelWriteAll

**NVM458:**

<b>Service name:</b>	<code>NvM_CancelWriteAll</code>
<b>Syntax:</b>	<code>void NvM_CancelWriteAll( )</code>
<b>Service ID[hex]:</b>	0x0a
<b>Sync/Async:</b>	Asynchronous
<b>Reentrancy:</b>	Non Reentrant
<b>Parameters (in):</b>	None
<b>Parameters (inout):</b>	None
<b>Parameters (out):</b>	None
<b>Return value:</b>	None
<b>Description:</b>	Service to cancel a running <code>NvM_WriteAll</code> request.

**NVM019:** The function `NvM_CancelWriteAll` shall cancel a running `NvM_WriteAll` request. It shall terminate the `NvM_WriteAll` request in a way that the data consistency during processing of a single NVRAM block is not compromised

**NVM232:** The function `NvM_CancelWriteAll` shall signal the request to the NvM module and return.

**NVM233:** The function `NvM_CancelWriteAll` shall be without any effect if no `NvM_WriteAll` request is pending.

**NVM234:** The function `NvM_CancelWriteAll` shall treat multiple requests to cancel a running `NvM_WriteAll` request as one request, i.e. subsequent requests will be ignored.

**NVM235:** The request result of the function `NvM_CancelWriteAll` shall be implicitly given by the result of the `NvM_WriteAll` request to be cancelled.

**NVM255:** The function `NvM_CancelWriteAll` shall ignore an already pending `NvM_CancelWriteAll` request.

**NVM236:** The function `NvM_CancelWriteAll` shall not modify any management information.

Regarding error detection, the requirement [NVM027](#) is applicable to the function `NvM_CancelWriteAll`.

**NVM419:** The NvM module's environment shall have initialized the NvM module before it calls the function `NvM_CancelWriteAll`.

**NVM420:** The function `NvM_CancelWriteAll` shall signal the NvM module and shall not be queued, i.e. there can be only one pending request of this type.

### 8.3.2.6 NvM\_InvalidateNvBlock

**NVM459:**

<b>Service name:</b>	NvM_InvalidateNvBlock	
<b>Syntax:</b>	Std_ReturnType NvM_InvalidateNvBlock( NvM_BlockIdType BlockId )	
<b>Service ID[hex]:</b>	0x0b	
<b>Sync/Async:</b>	Asynchronous	
<b>Reentrancy:</b>	Reentrant	
<b>Parameters (in):</b>	BlockId	The block identifier uniquely identifies one NVRAM block descriptor. A NVRAM block descriptor contains all needed information about a single NVRAM block.
<b>Parameters (inout):</b>	None	
<b>Parameters (out):</b>	None	
<b>Return value:</b>	Std_ReturnType	E_OK: request has been accepted E_NOT_OK: request has not been accepted
<b>Description:</b>	Service to invalidate a NV block.	

**NVM421:** The job of the function `NvM_InvalidateNvBlock` shall invalidate a NV block.

**NVM422:** The job of the function `NvM_InvalidateNvBlock` shall leave the RAM block unmodified.

**NVM423:** The function `NvM_InvalidateNvBlock` shall check the write protection attribute of the NV block in the administrative part of the corresponding RAM block.



**NVM424:** The function `NvM_InvalidateNvBlock` shall queue the request if the write protection of the corresponding NV block is disabled.

**NVM239:** The function `NvM_InvalidateNvBlock` shall take over the given parameters, queue the request and return.

**NVM272:** The function `NvM_InvalidateNvBlock` shall return with `E_NOT_OK` if a write protected NV block or a ROM block of a dataset NVRAM block is referenced by the `BlockId` parameter.

**NVM273:** The function `NvM_InvalidateNvBlock` shall check the write protection of a NVRAM block before the job is put into the job queue. The NvM module shall not re-check write protection before fetching the job from the job queue.

**NVM274:** If the referenced NVRAM block is of type `NVM_BLOCK_REDUNDANT`, the function `NvM_InvalidateNvBlock` shall only set the request result `NvM_RequestResultType` to `NVM_REQ_OK` when both NV blocks have been invalidated.

**NVM275:** The function `NvM_InvalidateNvBlock` shall set the job result to `NVM_REQ_NOT_OK` and report `NVM_E_REQ_FAILED` to the DEM if the processing of this service fails.

Regarding error detection, the requirement [NVM027](#) is applicable to the function `NvM_InvalidateNvBlock`.

**NVM425:** The NvM module's environment shall have initialized the NvM module before it calls the function `NvM_InvalidateNvBlock`.

NVRAM common block configuration parameters [\[NVM028\]](#), block management types [\[NVM061\]](#) and one configured NVRAM block descriptor are needed in the configuration with respect to the function `NvM_InvalidateBlock` [\[NVM062\]](#).

### 8.3.3 Asynchronous multi block requests

#### 8.3.3.1 NvM\_ReadAll

##### NVM460:

<b>Service name:</b>	NvM_ReadAll
<b>Syntax:</b>	void NvM_ReadAll( )
<b>Service ID[hex]:</b>	0x0c
<b>Sync/Async:</b>	Asynchronous
<b>Reentrancy:</b>	Non Reentrant
<b>Parameters (in):</b>	None
<b>Parameters (inout):</b>	None
<b>Parameters (out):</b>	None
<b>Return value:</b>	None
<b>Description:</b>	Initiates a multi block read request.

**NVM3566:** The multi block service `NvM_ReadAll` shall provide two distinct functionalities.

1. Initialize the management data for **all** NVRAM blocks (see [NVM304](#) ff)
2. Copy data to the permanent RAM blocks for those NVRAM blocks which are configured accordingly (see [NVM008](#) ff).

Note: The two functionalities can be implemented in one loop.

**NVM243:** The function `NvM_ReadAll` shall signal the request to the NvM module and return. The NVRAM Manager shall defer the processing of the requested ReadAll until all single block job queues are empty.

**NVM304:** The job of the function `NvM_ReadAll` shall set each proceeding block specific job result for NVRAM blocks and the multi block job result to `NVM_REQ_PENDING` in advance.

**NVM244:** The job of the function `NvM_ReadAll` shall iterate over all user NVRAM blocks, i.e. except for reserved Block Ids 0 (multi block request result) and 1 (NV configuration ID), beginning with the lowest Block Id.

**NVM362:** The NvM module shall initiate the recalculation of the RAM CRC for every NVRAM block with a valid permanent RAM block and `NvmCalcRamBlockCrc == TRUE` during the processing of `NvM_ReadAll`.

**NVM364:** The job of the function `NvM_ReadAll` shall treat the data for every recalculated RAM CRC which matches the stored RAM CRC as valid and set the block specific request result to `NVM_REQ_OK`.

Note: This mechanism enables the NVRAM Manager to avoid overwriting of maybe still valid RAM data with outdated NV data.

**NVM363:** The job of the function `NvM_ReadAll` shall treat invalid marked RAM blocks or the data for every recalculated RAM CRC which doesn't match the stored RAM CRC as invalid and restore the data from NV memory or load default values.

**NVM246:** The job of the function `NvM_ReadAll` shall validate the configuration ID by comparing the stored NVRAM configuration ID vs. the compiled NVRAM configuration ID [\[NVM034\]](#). The NVRAM block with the block ID 1 (redundant type with CRC) shall be reserved to contain the stored NVRAM configuration ID.

**NVM247:** The job of the function `NvM_ReadAll` shall process the normal runtime preparation for all configured NVRAM blocks and set the error/status information field of the corresponding NVRAM block's administrative block to `NVM_REQ_OK` in case of configuration ID match.

**NVM305:** The job of the function `NvM_ReadAll` shall report the production error `NVM_E_REQ_FAILED` to the DEM and set the error status field of the reserved NVRAM block to `NVM_REQ_INTEGRITY_FAILED` if the configuration ID cannot be read because of an error detected by one of the subsequent SW layers. The NvM module shall behave in the same way as if a configuration ID mismatch was detected.

**NVM307:** The job of the function `NvM_ReadAll` shall set the error/status information field of a NVRAM block's administrative block to `NVM_REQ_NOT_OK` in the case of configuration ID mismatch.

**NVM306:** In case the NvM module can not read the configuration ID because the corresponding NV blocks are empty or invalidated, the job of the function `NvM_ReadAll` shall not report a production error to the DEM but set the error/status information field in this NVRAM block's administrative block to `NVM_REQ_NV_INVALIDATED` and update the configuration Id according to [NVM310](#). The NvM module shall behave the same way as if the configuration ID matched.

**NVM248:** The job of the function `NvM_ReadAll` shall ignore a configuration ID mismatch and behave normal if `NvmDynamicConfiguration == FALSE` [\[NVM028\]](#).

**NVM249:** The job of the function `NvM_ReadAll` shall process the normal runtime preparation of all NVRAM blocks when they are configured with `NvmResistantToChangedSw == TRUE` [\[NVM061\]](#) and `NvmDynamicConfiguration == TRUE` [\[NVM028\]](#) and if a configuration ID mismatch occurs. The job of the function `NvM_ReadAll` shall process an extended

runtime preparation for all blocks which are configured with `NvmResistantToChangedSw == FALSE`.

**NVM314:** The job of the function `NvM_ReadAll` shall mark every NVRAM block that has not been detected by underlying SW as invalid and is configured with `NvmWriteBlockOnce == TRUE` as write protected.

Note: The function `NvM_SetBlockProtection` shall not be able to clear this write protection.

**NVM315:** The job of the function `NvM_ReadAll` shall only invalidate a NVRAM block of management type `NVM_BLOCK_REDUNDANT` if both NV blocks have been invalidated.

**NVM008:** The NvM module's environment shall use the multi block request `NvM_ReadAll` to load and validate the content of configured permanent RAM blocks during start-up [NVM091].

**NVM118:** The job of the function `NvM_ReadAll` shall process only the permanent RAM blocks which are configured with `NvmSelectBlockForReadall == TRUE`.

**NVM287:** The job of the function `NvM_ReadAll` shall set the job result to `NVM_REQ_BLOCK_SKIPPED` for all NVRAM blocks which are not loaded automatically during processing of the `NvM_ReadAll` job.

**NVM426:** If configured by `NvmDrvModeSwitch`, the job of the function `NvM_ReadAll` shall switch the mode of each memory device to "fast-mode" before starting to iterate over all user NVRAM blocks.

**NVM427:** If configured by `NvmDrvModeSwitch`, the job of the function `NvM_ReadAll` shall switch the mode of each memory device to "slow-mode" after having processed all user NVRAM blocks.

**NVM308:** The job of the function `NvM_ReadAll` shall load the ROM default data to the corresponding RAM blocks and set the error/status field in the administrative block to `NVM_REQ_OK` when processing the extended runtime preparation.

**NVM309:** When executing the extended runtime preparation, the job of the function `NvM_ReadAll` shall treat the affected NVRAM blocks as invalid or blank in order to allow rewriting of blocks configured with `NVM_BLOCK_WRITE_ONCE == TRUE`.

**NVM310:** The job of the function `NvM_ReadAll` shall update the configuration ID from the RAM block assigned to the reserved NVRAM block with ID 1 according to the new (compiled) configuration ID, mark the NVRAM block to be written during `NvM_WriteAll` and request a CRC recalculation if a configuration ID mismatch occurs and if the NVRAM block is configured with `NvmDynamicConfiguration == TRUE`.

**NVM311:** The NvM module shall allow applications to send any request for the reserved NVRAM Block, including `NvM_WriteBlock`, with respect to specified constraints and caveats.

**NVM312:** The NvM module shall not send a request for invalidation of the reserved configuration ID NVRAM block to the underlying layer, unless requested so by the application. This shall ensure that the NvM module's environment can rely on this block to be only invalidated at the first start-up of the ECU or if desired by the application.

**NVM313:** In case of a Configuration ID match, the job of the function `NvM_ReadAll` shall not automatically write to the Configuration ID block stored in the reserved NVRAM block 1.

**NVM288:** The job of the function `NvM_ReadAll` shall initiate a read attempt on the second NV block for each NVRAM block of type `NVM_BLOCK_REDUNDANT` [NVM118] and shall report no error to the DEM if the read attempt on the first NV block fails.

**NVM290:** The job of the function `NvM_ReadAll` shall set the block specific job result to `NVM_REQ_OK` if the job has successfully copied the corresponding NV block from NV memory to RAM.

**NVM342:** The job of the function `NvM_ReadAll` shall set the block specific job result to `NVM_REQ_NV_INVALIDATED` and shall report no error to the DEM if the MemIf reports `MEMIF_BLOCK_INVALID`.

**NVM360:** The job of the function `NvM_ReadAll` shall set the block specific job result to `NVM_REQ_INTEGRITY_FAILED` and report `NVM_E_INTEGRITY_FAILED` to the DEM if the MemIf reports `MEMIF_BLOCK_INCONSISTENT`.

**NVM361:** The job of the function `NvM_ReadAll` shall set the block specific job result to `NVM_REQ_NOT_OK` and report `NVM_E_REQ_FAILED` to the DEM, if the MemIf reports `MEMIF_JOB_FAILED`.

**NVM291:** The job of the function `NvM_ReadAll` shall set the block specific job result to `NVM_REQ_OK` if the corresponding block management type is `NVM_BLOCK_REDUNDANT` and the function has successfully copied one of the NV blocks from NV memory to RAM.

**NVM292:** The job of the function `NvM_ReadAll` shall request a CRC recalculation over the RAM block data after the copy process [NVM180] if the NV block is configured with CRC.

**NVM293:** The job of the function `NvM_ReadAll` shall load the default values to the RAM blocks according to the processing of `NvM_RestoreBlockDefaults` if the recalculated CRC is not equal to the CRC stored in NV memory or the read request

passed to the underlying layer fails. If there are no default values available, the job shall leave the RAM blocks invalid.

**NVM294:** The job of the function `NvM_ReadAll` shall report `NVM_E_INTEGRITY_FAILED` to the DEM if a CRC mismatch occurs.

**NVM295:** The job of the function `NvM_ReadAll` shall set a block specific job result to `NVM_REQ_INTEGRITY_FAILED` if a CRC mismatch occurs.

**NVM302:** The job of the function `NvM_ReadAll` shall report `NVM_E_REQ_FAILED` to the DEM if the referenced NVRAM Block is not configured with CRC and the corresponding job process has failed.

**NVM301:** The job of the function `NvM_ReadAll` shall set the multi block job result to `NVM_REQ_NOT_OK` if the job fails with the processing of at least one NVRAM block.

**NVM281:** If configured by `NvmSingleBlockCallback`, the job of the function `NvM_ReadAll` shall call the single block callback after having completely processed a NVRAM block.

Note: The idea behind using the single block callbacks also for multi-block requests is to speed up the software initialization process:

- A single-block callback issued from a multi-block request (e.g. `NvM_ReadAll`) will result in an RTE event.
- If the RTE is initialized after or during the asynchronous multi-block request (e.g. `NvM_ReadAll`), all or some of these RTE events will get lost because they are overwritten during the RTE initialization (see `rte_sws_2536`).
- After its initialization, the RTE can use the "surviving" RTE events to start software components even before the complete multi-block request (e.g. `NvM_ReadAll`) has been finished.
- For those RTE events that got lost during the initialization: the RTE will start those software components and the software components either query the status of the NV block they want to access or request that NV block to be read. This is exactly the same behavior if the single-block callbacks would not be used in multi-block requests.

**NVM251:** The job of the function `NvM_ReadAll` shall mark a NVRAM block as "valid/unmodified" if NV data has been successfully loaded to the RAM Block.

**NVM367:** The job of the function `NvM_ReadAll` shall set a RAM block to valid and assume it to be changed if the job has successfully copied default values to the corresponding RAM.

**NVM428:** The NvM module's environment shall have initialized the NvM module before it calls the function `NvM_ReadAll`.

**NVM429:** In Development Mode, the NvM module shall reject the function `NvM_ReadAll` if another multi block request is pending.

Regarding error detection, the requirement NVM027 is applicable to the function `NvM_ReadAll`.

The DEM shall already be able to accept error notifications.

NVRAM common block configuration parameters [NVM028], block management types [NVM061] and all configured NVRAM block descriptors are needed in the configuration with respect to the function `NvM_ReadAll` [NVM062], [NVM069].

### 8.3.3.2 NvM\_WriteAll

#### NVM461:

<b>Service name:</b>	NvM_WriteAll
<b>Syntax:</b>	void NvM_WriteAll(  )
<b>Service ID[hex]:</b>	0x0d
<b>Sync/Async:</b>	Asynchronous
<b>Reentrancy:</b>	Non Reentrant
<b>Parameters (in):</b>	None
<b>Parameters (inout):</b>	None
<b>Parameters (out):</b>	None
<b>Return value:</b>	None
<b>Description:</b>	Initiates a multi block write request.

**NVM018:** The job of the function `NvM_WriteAll` shall synchronize the contents of permanent RAM blocks to their corresponding NV blocks on shutdown.

**NVM733:** If NVRAM block ID 1 (which holds the configuration ID of the memory layout) is marked as "to be written during `NvM_WriteAll`", the job of the function `NvM_WriteAll` shall write this block in a final step (last write operation) to prevent memory layout mismatch in case of a power loss failure during write operation.

**NVM254:** The function `NvM_WriteAll` shall signal the request to the NvM module and return. The NVRAM Manager shall defer the processing of the requested WriteAll until all single block job queues are empty.

**NVM252:** The job of the function `NvM_WriteAll` shall process all permanent RAM blocks except for block ID 0.

**NVM430:** If configured by `NvmDrvModeSwitch`, the job of the function `NvM_WriteAll` shall set the mode of each memory device to "fast-mode" before starting to iterate over all non-reserved NVRAM blocks.

**NVM431:** If configured by `NvmDrvModeSwitch`, the job of the function `NvM_WriteAll` shall set the mode of each memory device to "slow-mode" after having processed all non-reserved NVRAM blocks or after the function `NvM_CancelWriteAll` has cancelled the job.

**NVM432:** The job of the function `NvM_WriteAll` shall check the write-protection and "valid/modified" state for each RAM block in advance.

**NVM433:** The job of the function `NvM_WriteAll` shall only write the content of a RAM block to its corresponding NV block for non write-protected NVRAM blocks.



**NVM474:** The job of the function `NvM_WriteAll` may write unchanged data, if this would repair (redundant) NV data. Otherwise it should not write unchanged data.

**NVM434:** The job of the function `NvM_WriteAll` shall skip every write-protected NVRAM block without error notification.

**NVM298:** The job of the function `NvM_WriteAll` shall set the job result for each NVRAM block which has not been written automatically by the job to `NVM_REQ_BLOCK_SKIPPED`.

**NVM339:** In case of NVRAM block management type `NVM_BLOCK_DATASET`, the job of the function `NvM_WriteAll` shall copy only the RAM block to the corresponding NV block which is selected via the data index in the administrative block.

**NVM253:** The job of the function `NvM_WriteAll` shall request a CRC recalculation and renew the CRC from a NVRAM block before writing the data if a CRC is configured for this NVRAM block.

**NVM296:** The job of the function `NvM_WriteAll` shall check the number of write retries [[NVM028](#)] by a write retry counter to avoid infinite loops. Each unsuccessful result reported by the MemIf module shall be followed by an increment of the retry counter. The job of the function `NvM_WriteAll` shall set the block specific job result to `NVM_REQ_NOT_OK` and report `NVM_E_REQ_FAILED` to the DEM if the write retry counter becomes greater than the configured `NVM_MAX_NO_OF_WRITE_RETRIES`.

**NVM337:** The job of the function `NvM_WriteAll` shall set the single block job result to `NVM_REQ_OK` if the processed NVRAM block is of type `NVM_BLOCK_REDUNDANT` and one of the NV blocks has been written successfully.

**NVM238:** The job of the function `NvM_WriteAll` shall complete the job in a non-destructive way for the NVRAM block currently being processed if a cancellation of `NvM_WriteAll` is signaled by a call of `NvM_CancelWriteAll`.

**NVM237:** The NvM module shall set the multi block request result to `NVM_REQ_CANCELLED` in case of cancellation of `NvM_WriteAll`. The NvM module shall anyway report the error code condition, due to a failed NVRAM block write, to the DEM.

**NVM318:** The job of the function `NvM_WriteAll` shall set the multi block request result to `NVM_REQ_NOT_OK` if processing of one or even more NVRAM blocks fails.

**NVM329:** If the job of the function `NvM_WriteAll` has successfully written data to NV memory for a NVRAM block configured with `NvmWriteBlockOnce == TRUE`, the job shall immediately set the corresponding write protection flag in the administrative block.

Regarding error detection, the requirement [NVM027](#) is applicable to the function `NvM_WriteAll`.

**NVM473:** In case of a RAM block is successfully copied to NV memory the RAM block state shall be set to "valid/unmodified" afterwards.

**NVM437:** The NvM module's environment shall have initialized the NvM module before it calls the function `NvM_WriteAll`.

No other multiblock request shall be pending when the NvM module's environment calls the function `NvM_WriteAll`.

Note: To avoid the situation that in case of redundant NVRAM blocks two different NV blocks are containing different but valid data at the same time, each client of the `NvM_WriteAll` service may call `NvM_InvalidateNvBlock` in advance.

NVRAM common block configuration parameters [\[NVM028\]](#), block management types [\[NVM061\]](#) and all configured NVRAM block descriptors are needed in the configuration with respect to the `NvM_WriteAll` function [\[NVM062\]](#), [\[NVM069\]](#).

## 8.4 Call-back notifications

### 8.4.1 Callback notification of the NvM module

**NVM438:** The NvM module shall provide callback functions to be used by the underlying memory abstraction (EEPROM abstraction / FLASH EEPROM Emulation) to signal end of job state with or without error.

**NVM439:** The file `NvM_Cbk.h` shall provide the function prototypes of the callback functions.

Note: The file `NvM_Cbk.h` is to be included by the underlying memory driver layers.

#### 8.4.1.1 NVRAM Manager job end notification without error

**NVM462:**

<b>Service name:</b>	<code>NvM_JobEndNotification</code>
<b>Syntax:</b>	<code>void NvM_JobEndNotification(  )</code>
<b>Service ID[hex]:</b>	<code>0x00</code>
<b>Sync/Async:</b>	Synchronous
<b>Reentrancy:</b>	Non Reentrant
<b>Parameters (in):</b>	None
<b>Parameters (inout):</b>	None
<b>Parameters (out):</b>	None

<b>Return value:</b>	None
<b>Description:</b>	Function to be used by the underlying memory abstraction to signal end of job without error.

**NVM111:** The callback function `NvM_JobEndNotification` is used by the underlying memory abstraction to signal end of job without error.

Note: Successful job end notification of the memory abstraction:

- Read finished & OK
- Write finished & OK
- Erase finished & OK

This routine might be called in interrupt context, depending on the calling function. All memory abstraction modules should be configured to use the same mode (callback/polling).

**NVM440:** The NvM module shall only provide the callback function `NvM_JobEndNotification` if polling mode is disabled via `NvmPollingMode`.

The function `NvM_JobEndNotification` is affected by the common [NVM028] configuration parameters.

#### 8.4.1.2 NVRAM Manager job end notification with error

**NVM463:**

<b>Service name:</b>	<code>NvM_JobErrorNotification</code>
<b>Syntax:</b>	<code>void NvM_JobErrorNotification( ) )</code>
<b>Service ID[hex]:</b>	0x00
<b>Sync/Async:</b>	Synchronous
<b>Reentrancy:</b>	Non Reentrant
<b>Parameters (in):</b>	None
<b>Parameters (inout):</b>	None
<b>Parameters (out):</b>	None
<b>Return value:</b>	None
<b>Description:</b>	Function to be used by the underlying memory abstraction to signal end of job with error.

**NVM112:** The callback function `NvM_JobErrorNotification` is to be used by the underlying memory abstraction to signal end of job with error.

Note: Unsuccessful job end notification of the memory abstraction:

- Read aborted or failed
- Write aborted or failed

- Erase aborted or failed

This routine might be called in interrupt context, depending on the calling function. All memory abstraction modules should be configured to use the same mode (callback/polling).

**NVM441:** The NvM module shall only provide the callback function `NvM_JobErrorNotification` if polling mode is disabled via `NvmPollingMode`.

The function `NvM_JoberrorNotification` is affected by the common [\[NVM028\]](#) configuration parameters.

## 8.5 Scheduled functions

These functions are directly called by the Basic Software Scheduler. The following functions shall have no return value and no parameter. All functions shall be non reentrant.

**.NVM322:** BSW module main processing functions are only allowed to be allocated to basic tasks by the function `NvM_MainFunction`.

### NVM464:

<b>Service name:</b>	<code>NvM_MainFunction</code>
<b>Syntax:</b>	<code>void NvM_MainFunction(  )</code>
<b>Service ID[hex]:</b>	0x0e
<b>Timing:</b>	VARIABLE_CYCLIC
<b>Description:</b>	Service for performing the processing of the NvM jobs.

**NVM256:** The function `NvM_MainFunction` shall perform the processing of the NvM module jobs.

**NVM333:** The function `NvM_MainFunction` shall perform the CRC recalculation if requested for a NVRAM block in addition to [NVM256](#).

**NVM334:** The NvM module shall only start writing of a block (i.e. hand over the job to the lower layers) after CRC calculation for this block has been finished.

**NVM257:** The NvM module shall only do/start job processing, queue management and CRC recalculation if the `NvM_Init` function has internally set an "INIT DONE" signal.

**NVM258:** The function `NvM_MainFunction` shall restart a destructively cancelled request caused by an immediate priority request after the NvM module has processed the immediate priority request [\[NVM152\]](#).

**NVM259:** The function `NvM_MainFunction` shall supervise the immediate priority queue (if configured) regarding the existence of immediate priority requests.

**NVM346:** If polling mode is enabled, the function `NvM_MainFunction` shall check the status of the requested job sent to the lower layer.

**NVM347:** If callback routines are configured, the function `NvM_MainFunction` shall call callback routines to the upper layer after completion of an asynchronous service.

**NVM350:** In case of processing an `NvM_WriteAll` multi block request, the function `NvM_MainFunction` shall not call callback routines to the upper layer as long as the service `MemIf_GetStatus` returns `MEMIF_BUSY_INTERNAL` for the reserved device ID `MEMIF_BROADCAST_ID` [6]. For this purpose (status is `MEMIF_BUSY_INTERNAL`), the function `NvM_MainFunction` shall cyclically poll the status of the Memory Hardware Abstraction independent of being configured for polling or callback mode.

**NVM349:** The function `NvM_MainFunction` shall return immediately if no further job processing is possible.

Note: NVRAM blocks with immediate priority are not expected to be configured to have a CRC.

**NVM324:** The NvM module's environment does not have to execute the function `NvM_MainFunction` in a specific order or sequence with respect to other BSW main processing function(s).

The function `NvM_MainFunction` is affected by the common [\[NVM028\]](#) configuration parameters.

Terms and definitions:

**Fixed cyclic:** Fixed cyclic means that one cycle time is defined at configuration and shall not be changed because functionality is requiring that fixed timing (e.g. filters).

**Variable cyclic:** Variable cyclic means that the cycle times are defined at configuration but might be mode dependent and therefore vary during runtime.

**On pre-condition:** On pre-condition means that no cycle time can be defined. The function is called when the conditions are fulfilled. Alternatively, the function may be called cyclically. However, the cycle time is assigned dynamically during runtime by other modules.

## 8.6 Expected Interfaces

In this chapter, all interfaces required by other modules are listed.

### 8.6.1 Mandatory Interfaces

**NVM319:** The following table defines all interfaces which are required to fulfill the core functionality of the module.

#### NVM465:

<i>API function</i>	<i>Description</i>
Dem_ReportErrorStatus	Reports errors to the DEM.
Memlf_Read	--
Memlf_InvalidateBlock	--
Memlf_GetJobResult	--
Memlf_Write	--
Memlf_EraseImmediateBlock	--
Memlf_GetStatus	--
Memlf_Cancel	--

### 8.6.2 Optional Interfaces

**NVM320:** The following table defines all interfaces which are required to fulfill an optional functionality of the module.

#### NVM466:

<i>API function</i>	<i>Description</i>
Det_ReportError	Service to report development errors.
Crc_CalculateCRC16	This service makes a CRC16 calculation on Crc_Length data bytes.
Crc_CalculateCRC32	This service makes a CRC32 calculation on Crc_Length data bytes.
Memlf_SetMode	--

### 8.6.3 Configurable interfaces

In this chapter, all interfaces are listed for which the target function can be configured. The target function is usually a callback function. The names of these interfaces are not fixed because they are configurable.

**NVM113:** The notification of a caller via an asynchronous callback routine (NvmSingleBlockCallback) shall be optionally configurable for all NV blocks (see NVM061).

**NVM740:** If a callback is configured for a NVRAM block, every asynchronous block request to the block itself shall be terminated with an invocation of the callback routine.

**NVM741:** The ID identifying the NVRAM service, shall be passed to the callback routine.

**NVM742:** If no callback is configured for a NVRAM block, there shall be no asynchronous notification of the caller in case of an asynchronous block request.

**NVM260:** A common callback entry (`NvmMultiBlockCallback`) which is not bound to any NVRAM block [[NVM028](#)] shall be optionally configurable for all asynchronous multi block requests (including `NvM_CancelWriteAll`). The ID identifying the NVRAM service shall be passed to the common callback routine. If a NULL pointer is configured for the common callback entry, there shall be no asynchronous notification of the caller in case of asynchronous multi block requests (including `NvM_CancelWriteAll`).

### 8.6.3.1 Single block job end notification

#### NVM467:

<b>Service name:</b>	SingleBlockCallbackFunction	
<b>Syntax:</b>	<pre>Std_ReturnType SingleBlockCallbackFunction(     uint8 ServiceId,     NvM_RequestResultType JobResult )</pre>	
<b>Sync/Async:</b>	Synchronous	
<b>Reentrancy:</b>	Non Reentrant	
<b>Parameters (in):</b>	ServiceId	Unique Service ID of NVRAM manager service.
	JobResult	Covers the job result of the previous processed single block job.
<b>Parameters (inout):</b>	None	
<b>Parameters (out):</b>	None	
<b>Return value:</b>	Std_ReturnType	E_OK: Callback function has been processed successfully. E_NOT_OK: Callback function has not been processed successfully.
<b>Description:</b>	Per block callback routine to notify the upper layer that an asynchronous single block request has been finished.	

**NVM368:** The single block callback function shall always return with `E_OK`.

There is no need for the NvM module to evaluate the return value of the single block callback function because of [NVM368](#).

**NVM330:** The single block callback function shall be a function pointer.

Note: Please refer to `NvmSingleBlockCallback` in chapter 10.

The Single block job end notification might be called in interrupt context, depending on the calling function.

### 8.6.3.2 Multi block job end notification

#### NVM468:

<b>Service name:</b>	MultiBlockCallbackFunction	
<b>Syntax:</b>	<pre>void MultiBlockCallbackFunction(     uint8 ServiceId,     NvM_RequestResultType JobResult )</pre>	
<b>Sync/Async:</b>	Synchronous	
<b>Reentrancy:</b>	Non Reentrant	
<b>Parameters (in):</b>	ServiceId	Unique Service ID of NVRAM manager service.
	JobResult	Covers the job result of the previous processed multi block job.
<b>Parameters (inout):</b>	None	
<b>Parameters (out):</b>	None	
<b>Return value:</b>	None	
<b>Description:</b>	Common callback routine to notify the upper layer that an asynchronous multi block request has been finished.	

**NVM331:** The Multi block job end notification shall be a function pointer.

Note: Please refer to `NvmMultiBlockCallback` in chapter 10.

The Multi block job end notification might be called in interrupt context, depending on the calling function.

### 8.6.3.3 Callback function for block initialization

#### NVM469:

<b>Service name:</b>	InitBlockCallbackFunction	
<b>Syntax:</b>	<pre>Std_ReturnType InitBlockCallbackFunction( )</pre>	
<b>Sync/Async:</b>	Synchronous	
<b>Reentrancy:</b>	Non Reentrant	
<b>Parameters (in):</b>	None	
<b>Parameters (inout):</b>	None	
<b>Parameters (out):</b>	None	
<b>Return value:</b>	Std_ReturnType	E_OK: callback function has been processed successfully E_NOT_OK: callback function has not been processed successfully
<b>Description:</b>	Per block callback routine which shall be called by the NvM module to copy default data to a RAM block if a ROM block isn't configured.	

**NVM369:** The Init block callback for block initialization shall always return with `E_OK`.



There is no need for the NvM module to evaluate the return value of the callback function because of [NVM369](#).

**NVM352:** The Init block callback shall be a function pointer.

Note: Please refer to `NvmInitBlockCallback` in chapter 10.

The init block callback function might be called in interrupt context.

## 8.7 API Overview

<b>Request Types</b>	<b>Characteristics of Request Types</b>
Type 1: - NvM_SetDataIndex (...) - NvM_GetDataIndex (...) - NvM_SetBlockProtection (...) - NvM_GetErrorStatus(...) - NvM_SetRamBlockStatus(...)	- synchronous request - affects one RAM block - available for all SW-Cs
Type 2: - NvM_ReadBlock(...) - NvM_WriteBlock(...) - NvM_RestoreBlockDefaults(...) - NvM_EraseNvBlock(...) - NvM_InvalidateNvBlock(...)	- asynchronous request (result via callback or polling) - affects one NVRAM block - handled by NVRAM manager task via request list - available for all SW-Cs
Type 3: - NvM_ReadAll(...) - NvM_WriteAll(...) - NvM_CancelWriteAll(...)	- asynchronous request (result via callback or polling) - affects all NVRAM blocks with permanent RAM data
Type 4: - NvM_Init(...)	- synchronous request - basic initialization - success signaled to the task via command interface inside the function itself

## 9 Sequence Diagrams

### 9.1 Synchronous calls

#### 9.1.1 NvM\_Init

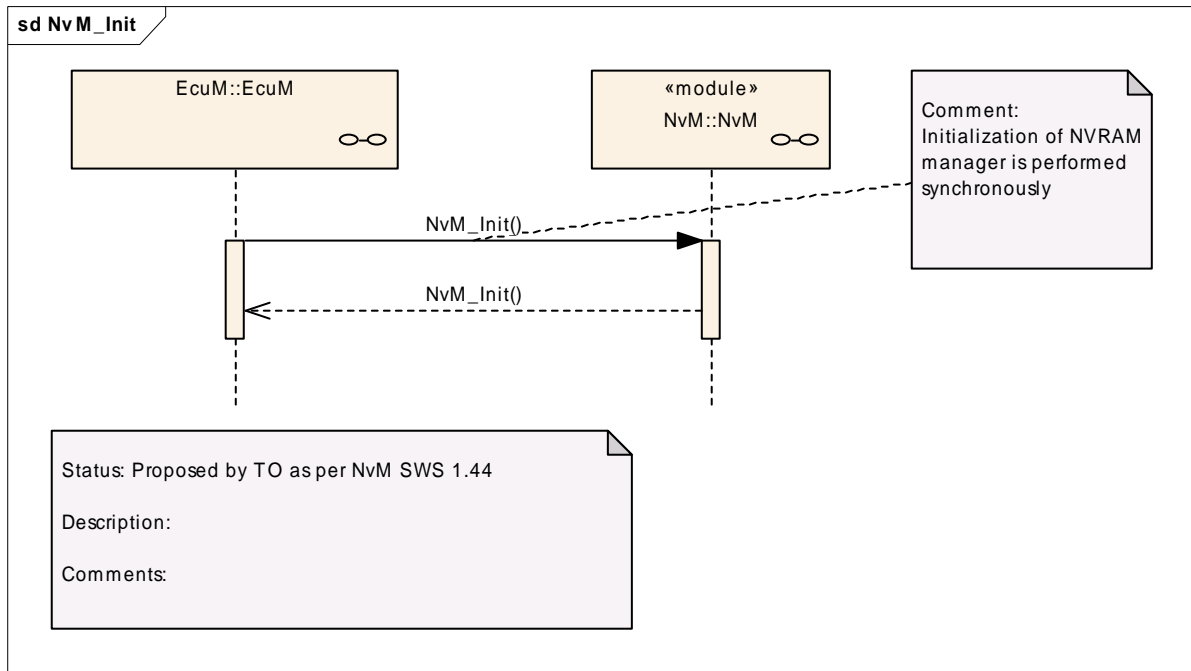

Figure 10: UML sequence diagram NvM\_Init

#### 9.1.2 NvM\_SetDataIndex

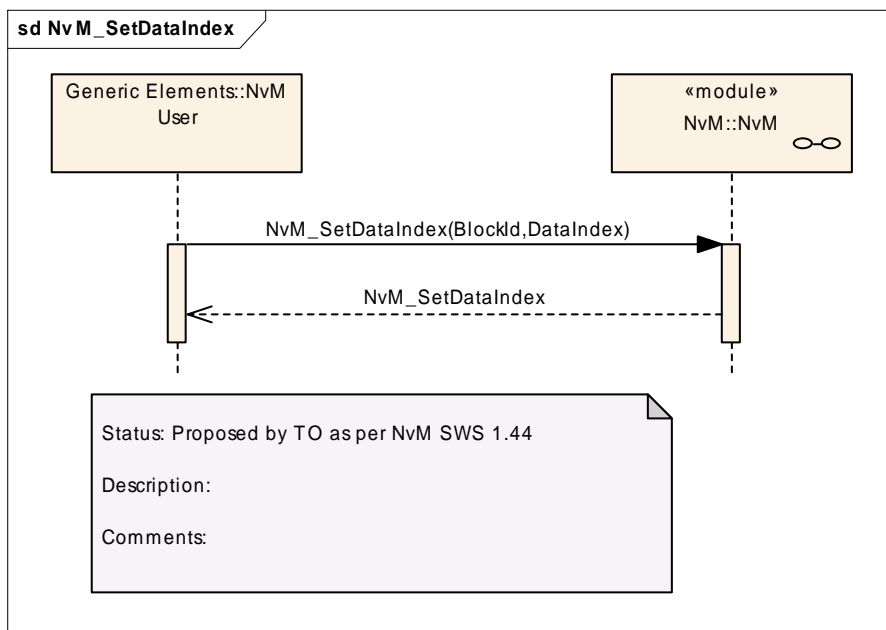

Figure 11: UML sequence diagram NvM\_SetDataIndex

### 9.1.3 NvM\_GetDataIndex

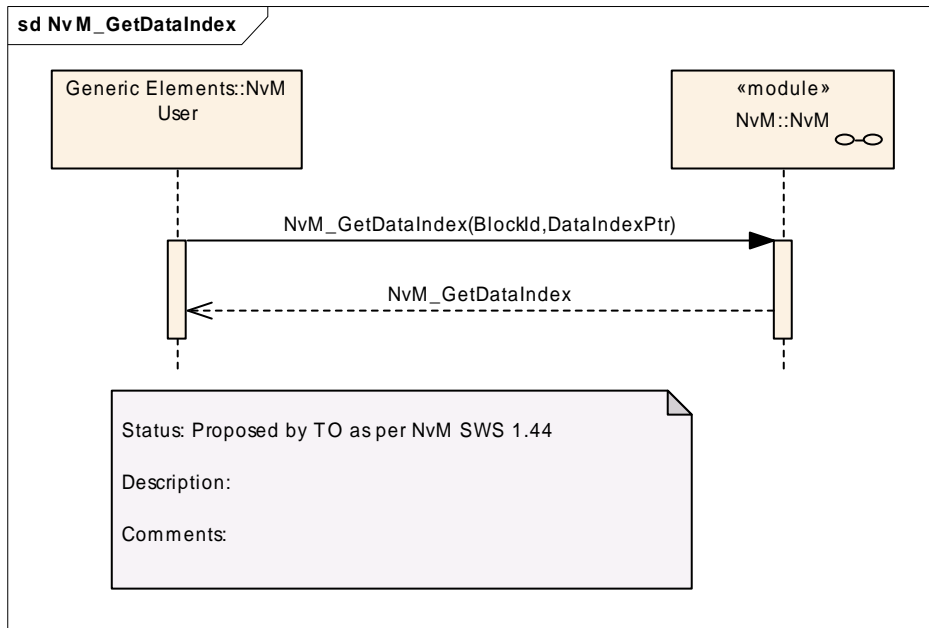

Figure 12: UML sequence diagram NvM\_GetDataIndex

### 9.1.4 NvM\_SetBlockProtection

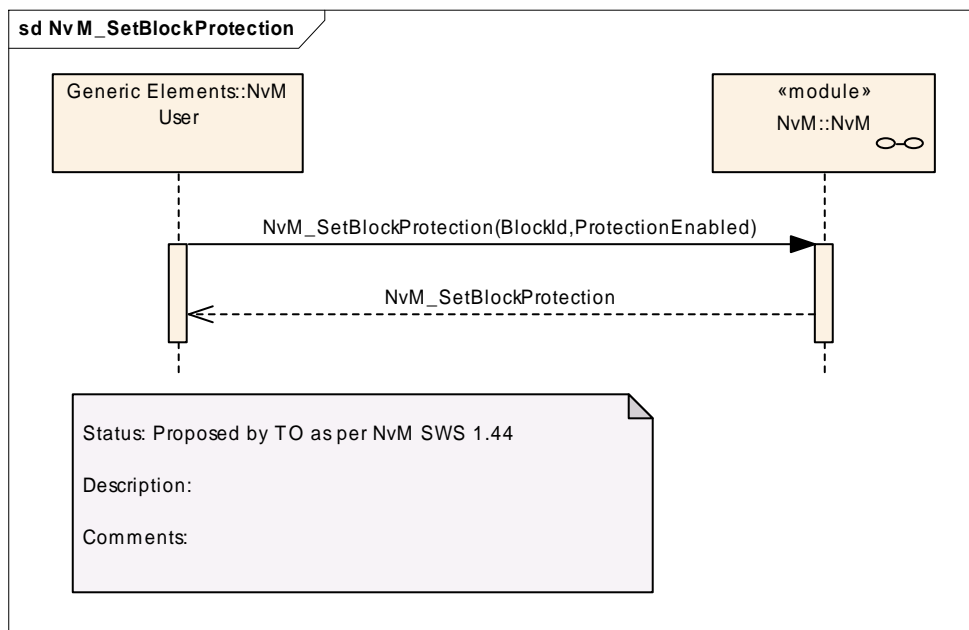
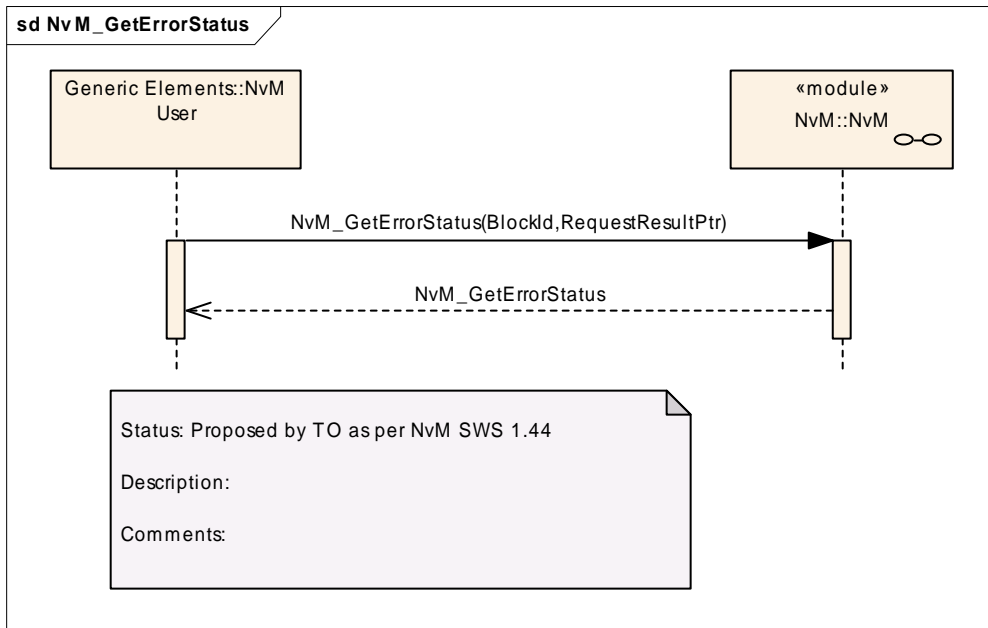

Figure 13: UML sequence diagram NvM\_SetBlockProtection

**9.1.5 NvM\_GetErrorStatus**



**Figure 14: UML sequence diagram NvM\_GetErrorStatus**

**9.1.6 NvM\_GetVersionInfo**

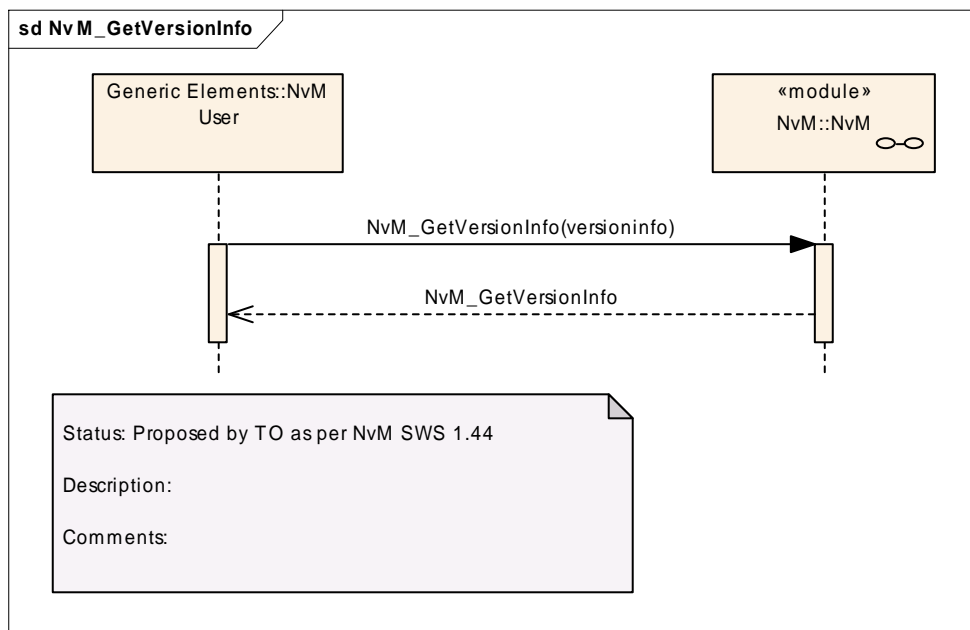

**Figure 15: UML sequence diagram NvM\_GetVersionInfo**

**9.2 Asynchronous calls**

The following sequence diagrams concentrate on the interaction between the NvM module and SW-C's or the ECU state manager. For interaction regarding the Memory Interface please ref. to [4] or [5].

### 9.2.1 Asynchronous call with polling

The following diagram shows the function `NvM_WriteBlock` as an example of a request that is performed asynchronously. The sequence for all other asynchronous functions is the same, only the processed number of blocks and the block types may vary. The result of the asynchronous function is obtained by polling requests to the error/status information.

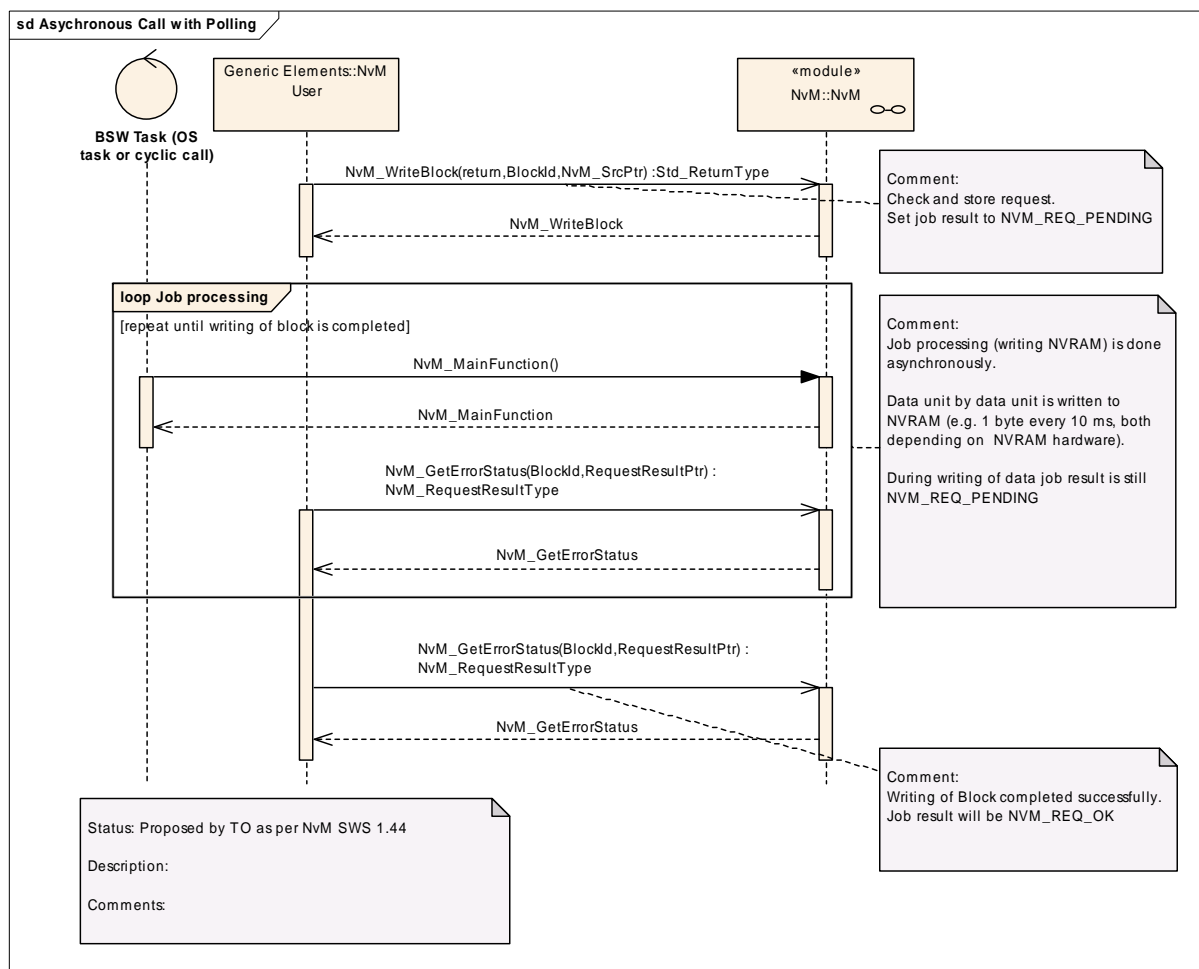
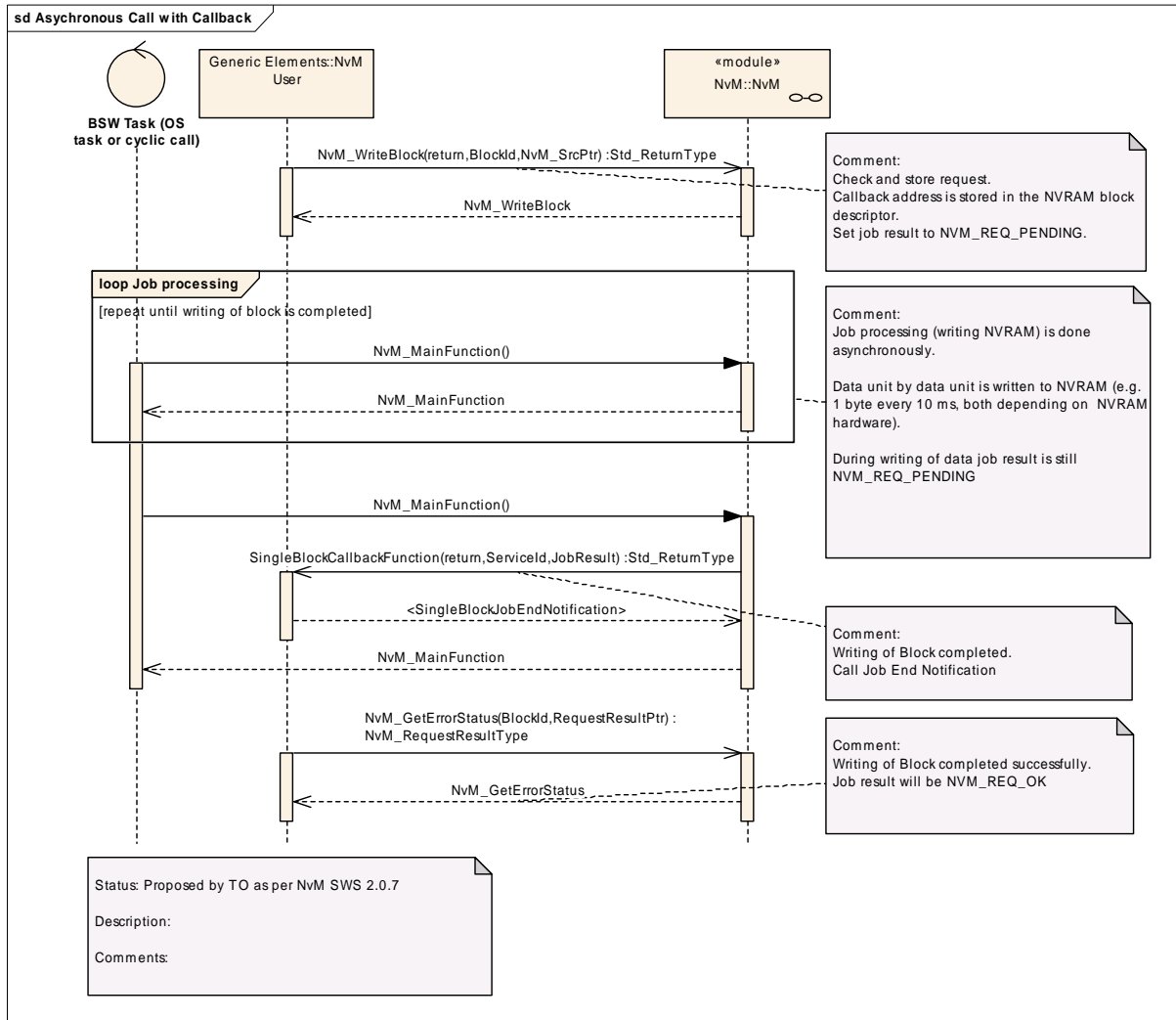

Figure 16: UML sequence diagram for asynchronous call with polling

### 9.2.2 Asynchronous call with callback

The following diagram shows the function `NvM_WriteBlock` as an example of a request that is performed asynchronously. The sequence for all other asynchronous functions is the same, only the processed number of blocks and the block types may vary. The result of the asynchronous function is obtained after an asynchronous notification (callback) by requesting the error/status information.



**Figure 17: UML sequence diagram for asynchronous call with callback**

### 9.2.3 Cancellation of a Multi Block Request

The following diagram shows the effect of a cancel operation applied to a running NvM\_WriteAll multi block request. The running NvM\_WriteAll function completes the actual NVRAM block and stops further writes.

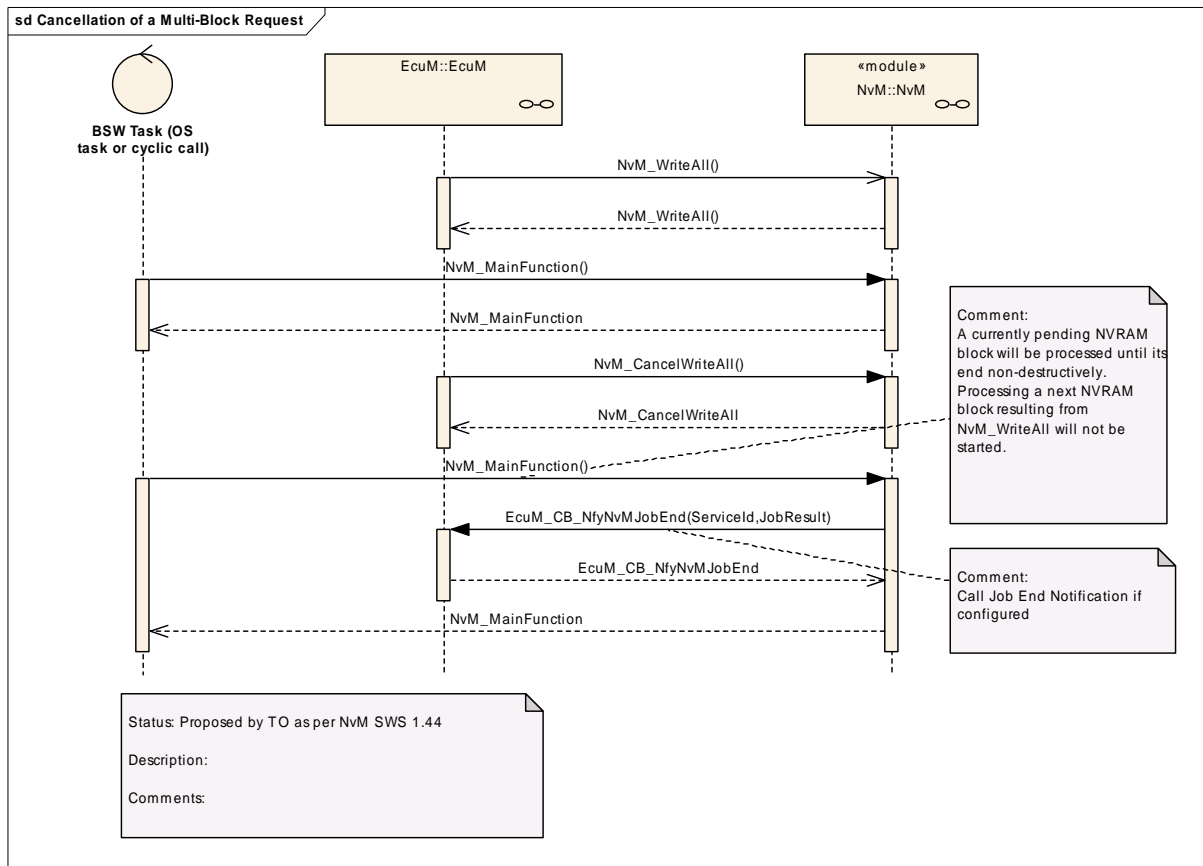

**Figure 18: UML sequence diagram for cancellation of asynchronous call**

## 10 Configuration specification

In general, this chapter defines configuration parameters and their clustering into containers. In order to support the specification Chapter 10.1 describes fundamentals. It also specifies a template (table) you shall use for the parameter specification.

Chapter 10.2 specifies the structure (containers) and the parameters of the module NvM.

Chapter 10.3 specifies published information of the module NvM.

### 10.1 How to read this chapter

In addition to this section, it is highly recommended to read the documents:

- AUTOSAR Layered Software Architecture [\[1\]](#)
- AUTOSAR ECU Configuration Specification [\[11\]](#)  
This document describes the AUTOSAR configuration methodology and the AUTOSAR configuration metamodel in detail.

The following is only a short survey of the topic and it will not replace the ECU Configuration Specification document.

#### 10.1.1 Configuration and configuration parameters

Configuration parameters define the variability of the generic part(s) of an implementation of a module. This means that only generic or configurable module implementation can be adapted to the environment (software/hardware) in use during system and/or ECU configuration.

The configuration of parameters can be achieved at different times during the software process: before compile time, before link time or after build time. In the following, the term “configuration class” (of a parameter) shall be used in order to refer to a specific configuration point in time.

#### 10.1.2 Variants

Variants describe sets of configuration parameters. E.g., variant 1: only pre-compile time configuration parameters; variant 2: mix of pre-compile- and post build time-configuration parameters. In one variant a parameter can only be of one configuration class.

#### 10.1.3 Containers

Containers structure the set of configuration parameters. This means:

- *all* configuration parameters are kept in containers.
- (sub-) containers can reference (sub-) containers. It is possible to assign a multiplicity to these references. The multiplicity then defines the possible number of instances of the contained parameters.



## 10.2 Containers and configuration parameters

The following chapters summarize all configuration parameters. The detailed meanings of the parameters describe chapter 7.2 and chapter 8.

### 10.2.1 Variants

Variant1: This variant allows only pre-compile time configuration parameters.

### 10.2.2 NvM

<b>Module Name</b>	<b>NvM</b>
<b>Module Description</b>	Configuration of the NvM (NvRam Manager) module.

<b>Included Containers</b>		
<b>Container Name</b>	<b>Multiplicity</b>	<b>Scope / Dependency</b>
NvmBlockDescriptor	1..65536	Container for a management structure to configure the composition of a given NVRAM Block Management Type. Its multiplicity describes the number of configured NVRAM blocks, one block is required to be configured. The NVRAM block descriptors are condensed in the NVRAM block descriptor table.
NvmCommon	1	Container for common configuration options.

### 10.2.3 NvmCommon

<b>SWS Item</b>	<b>NVM028 :</b>
<b>Container Name</b>	NvmCommon
<b>Description</b>	Container for common configuration options.
<b>Configuration Parameters</b>	

<b>SWS Item</b>	<b>NVM491 :</b>	
<b>Name</b>	NvmApiConfigClass {NVM_API_CONFIG_CLASS}	
<b>Description</b>	Preprocessor switch to enable some API calls which are related to NVM API configuration classes.	
<b>Multiplicity</b>	1	
<b>Type</b>	EnumerationParamDef	
<b>Range</b>	NVM_API_CONFIG_CLASS_1	All API calls belonging to configuration class 1 are available.
	NVM_API_CONFIG_CLASS_2	All API calls belonging to configuration class 2 are available.
	NVM_API_CONFIG_CLASS_3	All API calls belonging to configuration class 3 are available.
<b>ConfigurationClass</b>	<b>Pre-compile time</b>	X All Variants
	<b>Link time</b>	--
	<b>Post-build time</b>	--
<b>Scope / Dependency</b>	scope: module	

<b>SWS Item</b>	<b>NVM492 :</b>		
<b>Name</b>	NvmCompiledConfigId {NVM_COMPILED_CONFIG_ID}		
<b>Description</b>	Configuration ID regarding the NV memory layout. This configuration ID shall be published as e.g. a SW-C shall have the possibility to write it to NV memory.		
<b>Multiplicity</b>	1		
<b>Type</b>	IntegerParamDef		
<b>Range</b>	0 .. 65535		
<b>Default value</b>	--		
<b>ConfigurationClass</b>	<b>Pre-compile time</b>	X	All Variants
	<b>Link time</b>	--	
	<b>Post-build time</b>	--	
<b>Scope / Dependency</b>	scope: module		

<b>SWS Item</b>	<b>NVM493 :</b>		
<b>Name</b>	NvmCrcNumOfBytes {NVM_CRC_NUM_OF_BYTES}		
<b>Description</b>	If CRC is configured for at least one NVRAM block, this parameter defines the maximum number of bytes which shall be processed within one cycle of job processing.		
<b>Multiplicity</b>	1		
<b>Type</b>	IntegerParamDef		
<b>Range</b>	1 .. 65535		
<b>Default value</b>	--		
<b>ConfigurationClass</b>	<b>Pre-compile time</b>	X	All Variants
	<b>Link time</b>	--	
	<b>Post-build time</b>	--	
<b>Scope / Dependency</b>	scope: module dependency: CRC library		

<b>SWS Item</b>	<b>NVM494 :</b>		
<b>Name</b>	NvmDatasetSelectionBits {NVM_DATASET_SELECTION_BITS}		
<b>Description</b>	Defines the number of least significant bits which shall be used to address a certain dataset of a NVRAM block within the interface to the memory hardware abstraction. 0..8: Number of bits which are used for dataset or redundant block addressing. 0: No dataset or redundant NVRAM blocks are configured at all, no selection bits required. 1: In case of redundant NVRAM blocks are configured, but no dataset NVRAM blocks.		
<b>Multiplicity</b>	1		
<b>Type</b>	IntegerParamDef		
<b>Range</b>	0 .. 8		
<b>Default value</b>	--		
<b>ConfigurationClass</b>	<b>Pre-compile time</b>	X	All Variants
	<b>Link time</b>	--	
	<b>Post-build time</b>	--	
<b>Scope / Dependency</b>	scope: ECU dependency: MemHwA, NVM_NV_BLOCK_IDENTIFIER, NVM_BLOCK_MANAGEMENT_TYPE		

<b>SWS Item</b>	<b>NVM495 :</b>		
<b>Name</b>	NvmDevErrorDetect {NVM_DEV_ERROR_DETECT}		
<b>Description</b>	Pre-processor switch to enable and disable development error detection.		

	true: Development error detection enabled. false: Development error detection disabled.		
<b>Multiplicity</b>	1		
<b>Type</b>	BooleanParamDef		
<b>Default value</b>	--		
<b>ConfigurationClass</b>	<b>Pre-compile time</b>	X	All Variants
	<b>Link time</b>	--	
	<b>Post-build time</b>	--	
<b>Scope / Dependency</b>	scope: module		

<b>SWS Item</b>	<b>NVM496 :</b>		
<b>Name</b>	NvmDrvModeSwitch {NVM_DRV_MODE_SWITCH}		
<b>Description</b>	Preprocessor switch to enable switching memory drivers to fast mode during performing NvM_ReadAll and NvM_WriteAll true: Fast mode enabled. false: Fast mode disabled.		
<b>Multiplicity</b>	1		
<b>Type</b>	BooleanParamDef		
<b>Default value</b>	--		
<b>ConfigurationClass</b>	<b>Pre-compile time</b>	X	All Variants
	<b>Link time</b>	--	
	<b>Post-build time</b>	--	
<b>Scope / Dependency</b>	scope: module		

<b>SWS Item</b>	<b>NVM497 :</b>		
<b>Name</b>	NvmDynamicConfiguration {NVM_DYNAMIC_CONFIGURATION}		
<b>Description</b>	Preprocessor switch to enable the dynamic configuration management handling by the NvM_ReadAll request. true: Dynamic configuration management handling enabled. false: Dynamic configuration management handling disabled.		
<b>Multiplicity</b>	1		
<b>Type</b>	BooleanParamDef		
<b>Default value</b>	--		
<b>ConfigurationClass</b>	<b>Pre-compile time</b>	X	All Variants
	<b>Link time</b>	--	
	<b>Post-build time</b>	--	
<b>Scope / Dependency</b>	scope: module		

<b>SWS Item</b>	<b>NVM498 :</b>		
<b>Name</b>	NvmJobPrioritization {NVM_JOB_PRIORITIZATION}		
<b>Description</b>	Preprocessor switch to enable job prioritization handling true: Job prioritization handling enabled. false: Job prioritization handling disabled.		
<b>Multiplicity</b>	1		
<b>Type</b>	BooleanParamDef		
<b>Default value</b>	--		
<b>ConfigurationClass</b>	<b>Pre-compile time</b>	X	All Variants
	<b>Link time</b>	--	
	<b>Post-build time</b>	--	
<b>Scope / Dependency</b>	scope: module		

<b>SWS Item</b>	<b>NVM499 :</b>		
<b>Name</b>	NvmMaxNoOfWriteRetries {NVM_MAX_NUM_OF_WRITE_RETRIES}		
<b>Description</b>	Defines the maximum number of write retries for a NVRAM block with [NVM061]. Regardless of configuration a consistency check (and maybe write retries) are always forced for each block which is processed by the		

	request NvM_WriteAll and NvM_WriteBlock.		
<b>Multiplicity</b>	1		
<b>Type</b>	IntegerParamDef		
<b>Range</b>	0 .. 7		
<b>Default value</b>	--		
<b>ConfigurationClass</b>	<b>Pre-compile time</b>	X	All Variants
	<b>Link time</b>	--	
	<b>Post-build time</b>	--	
<b>Scope / Dependency</b>	scope: module		

<b>SWS Item</b>	<b>NVM500 :</b>		
<b>Name</b>	NvmMultiBlockCallback {NVM_MULTI_BLOCK_CALLBACK}		
<b>Description</b>	Entry address of the common callback routine which shall be invoked on termination of each asynchronous multi block request		
<b>Multiplicity</b>	1		
<b>Type</b>	FunctionNameDef		
<b>Default value</b>	--		
<b>ConfigurationClass</b>	<b>Pre-compile time</b>	X	All Variants
	<b>Link time</b>	--	
	<b>Post-build time</b>	--	
<b>Scope / Dependency</b>	scope: module		

<b>SWS Item</b>	<b>NVM501 :</b>		
<b>Name</b>	NvmPollingMode {NVM_POLLING_MODE}		
<b>Description</b>	Preprocessor switch to enable/disable the polling mode in the NVRAM Manager and at the same time disable/enable the callback functions useable by lower layers true: Polling mode enabled, callback function usage disabled. false: Polling mode disabled, callback function usage enabled.		
<b>Multiplicity</b>	1		
<b>Type</b>	BooleanParamDef		
<b>Default value</b>	--		
<b>ConfigurationClass</b>	<b>Pre-compile time</b>	X	All Variants
	<b>Link time</b>	--	
	<b>Post-build time</b>	--	
<b>Scope / Dependency</b>	scope: module		

<b>SWS Item</b>	<b>NVM502 :</b>		
<b>Name</b>	NvmSetRamBlockStatusApi {NVM_SET_RAM_BLOCK_STATUS_API}		
<b>Description</b>	Preprocessor switch to enable the API NvM_SetRamBlockStatus. true: API NvM_SetRamBlockStatus enabled. false: API NvM_SetRamBlockStatus disabled.		
<b>Multiplicity</b>	1		
<b>Type</b>	BooleanParamDef		
<b>Default value</b>	--		
<b>ConfigurationClass</b>	<b>Pre-compile time</b>	X	All Variants
	<b>Link time</b>	--	
	<b>Post-build time</b>	--	
<b>Scope / Dependency</b>	scope: module		

<b>SWS Item</b>	<b>NVM503 :</b>		
<b>Name</b>	NvmSizeImmediateJobQueue {NVM_SIZE_IMMEDIATE_JOB_QUEUE}		
<b>Description</b>	Defines the number of queue entries for the immediate priority job queue.		

	If NVM_JOB_PRIORITIZATION is switched OFF this parameter shall be out of scope.		
<b>Multiplicity</b>	1		
<b>Type</b>	IntegerParamDef		
<b>Range</b>	1 .. 255		
<b>Default value</b>	--		
<b>ConfigurationClass</b>	<b>Pre-compile time</b>	X	All Variants
	<b>Link time</b>	--	
	<b>Post-build time</b>	--	
<b>Scope / Dependency</b>	scope: module dependency: NVM_JOB_PRIORITIZATION		

<b>SWS Item</b>	<b>NVM504 :</b>		
<b>Name</b>	NvmSizeStandardJobQueue {NVM_SIZE_STANDARD_JOB_QUEUE}		
<b>Description</b>	Defines the number of queue entries for the standard job queue.		
<b>Multiplicity</b>	1		
<b>Type</b>	IntegerParamDef		
<b>Range</b>	1 .. 255		
<b>Default value</b>	--		
<b>ConfigurationClass</b>	<b>Pre-compile time</b>	X	All Variants
	<b>Link time</b>	--	
	<b>Post-build time</b>	--	
<b>Scope / Dependency</b>	scope: module		

<b>SWS Item</b>	<b>NVM505 :</b>		
<b>Name</b>	NvmVersionInfoApi {NVM_VERSION_INFO_API}		
<b>Description</b>	Pre-processor switch to enable / disable the API to read out the modules version information [NVM285], [NVM286]. true: Version info API enabled. false: Version info API disabled.		
<b>Multiplicity</b>	1		
<b>Type</b>	BooleanParamDef		
<b>Default value</b>	--		
<b>ConfigurationClass</b>	<b>Pre-compile time</b>	X	All Variants
	<b>Link time</b>	--	
	<b>Post-build time</b>	--	
<b>Scope / Dependency</b>	scope: module		

**No Included Containers**

**NVM028:** The following tables specify parameters that shall be definable in the module's configuration file (NvM\_Cfg.h).

**NVM321:** Pre-compile time configuration parameters to be implemented as "const" should be placed into a separate c-file (NvM\_Cfg.c).

### 10.2.4 NvmBlockDescriptor

<b>SWS Item</b>	<b>NVM061 :</b>
<b>Container Name</b>	NvmBlockDescriptor
<b>Description</b>	Container for a management structure to configure the composition of a given NVRAM Block Management Type. Its multiplicity describes the number of configured NVRAM blocks, one block is required to be configured. The NVRAM block descriptors are condensed in the NVRAM block descriptor table.
<b>Configuration Parameters</b>	

<b>SWS Item</b>	<b>NVM476 :</b>		
<b>Name</b>	NvmBlockCRCType {NVM_BLOCK_CRC_TYPE}		
<b>Description</b>	Defines CRC data width for the NVRAM block. Default: NVM_CRC16, i.e. CRC16 will be used if NVM_BLOCK_USE_CRC==TRUE		
<b>Multiplicity</b>	1		
<b>Type</b>	EnumerationParamDef		
<b>Range</b>	NVM_CRC16	(Default) CRC16 will be used if NVM_BLOCK_USE_CRC==TRUE.	
	NVM_CRC32	CRC32 is selected for this NVRAM block.	
<b>ConfigurationClass</b>	<b>Pre-compile time</b>	X	All Variants
	<b>Link time</b>	--	
	<b>Post-build time</b>	--	
<b>Scope / Dependency</b>	scope: module dependency: NVM_BLOCK_USE_CRC, NVM_CALC_RAM_BLOCK_CRC		

<b>SWS Item</b>	<b>NVM477 :</b>		
<b>Name</b>	NvmBlockJobPriority {NVM_BLOCK_JOB_PRIORITY}		
<b>Description</b>	Defines the job priority for a NVRAM block (0 = Immediate priority).		
<b>Multiplicity</b>	1		
<b>Type</b>	IntegerParamDef		
<b>Range</b>	0 .. 255		
<b>Default value</b>	--		
<b>ConfigurationClass</b>	<b>Pre-compile time</b>	X	All Variants
	<b>Link time</b>	--	
	<b>Post-build time</b>	--	
<b>Scope / Dependency</b>	scope: module		

<b>SWS Item</b>	<b>NVM062 :</b>		
<b>Name</b>	NvmBlockManagementType {NVM_BLOCK_MANAGEMENT_TYPE}		
<b>Description</b>	Defines the block management type for the NVRAM block.[NVM137]		
<b>Multiplicity</b>	1		
<b>Type</b>	EnumerationParamDef		
<b>Range</b>	NVM_BLOCK_DATASET	NVRAM block is configured to be of dataset type.	
	NVM_BLOCK_NATIVE	NVRAM block is configured to be of native type.	
	NVM_BLOCK_REDUNDANT	NVRAM block is configured to be of	

		redundant type.	
<b>ConfigurationClass</b>	<b>Pre-compile time</b>	X	All Variants
	<b>Link time</b>	--	
	<b>Post-build time</b>	--	
<b>Scope / Dependency</b>	scope: module		

<b>SWS Item</b>	<b>NVM036 :</b>		
<b>Name</b>	NvmBlockUseCrc {NVM_BLOCK_USE_CRC}		
<b>Description</b>	Defines CRC usage for the NVRAM block, i.e. memory space for CRC is reserved in RAM and NV memory. true: CRC will be used for this NVRAM block. false: CRC will not be used for this NVRAM block.		
<b>Multiplicity</b>	1		
<b>Type</b>	BooleanParamDef		
<b>Default value</b>	--		
<b>ConfigurationClass</b>	<b>Pre-compile time</b>	X	All Variants
	<b>Link time</b>	--	
	<b>Post-build time</b>	--	
<b>Scope / Dependency</b>	scope: module		

<b>SWS Item</b>	<b>NVM033 :</b>		
<b>Name</b>	NvmBlockWriteProt {NVM_BLOCK_WRITE_PROT}		
<b>Description</b>	Defines an initial write protection of the NV block true: Initial block write protection is enabled. false: Initial block write protection is disabled.		
<b>Multiplicity</b>	1		
<b>Type</b>	BooleanParamDef		
<b>Default value</b>	--		
<b>ConfigurationClass</b>	<b>Pre-compile time</b>	X	All Variants
	<b>Link time</b>	--	
	<b>Post-build time</b>	--	
<b>Scope / Dependency</b>	scope: module		

<b>SWS Item</b>	<b>NVM119 :</b>		
<b>Name</b>	NvmCalcRamBlockCrc {NVM_CALC_RAM_BLOCK_CRC}		
<b>Description</b>	Defines CRC (re)calculation for the permanent RAM block true: CRC will be (re)calculated for this permanent RAM block. false: CRC will not be (re)calculated for this permanent RAM block.		
<b>Multiplicity</b>	1		
<b>Type</b>	BooleanParamDef		
<b>Default value</b>	--		
<b>ConfigurationClass</b>	<b>Pre-compile time</b>	X	All Variants
	<b>Link time</b>	--	
	<b>Post-build time</b>	--	
<b>Scope / Dependency</b>	scope: module dependency: NVM_BLOCK_USE_CRC		

<b>SWS Item</b>	<b>NVM116 :</b>		
<b>Name</b>	NvmInitBlockCallback {NVM_INIT_BLOCK_CALLBACK}		
<b>Description</b>	Entry address of a block specific callback routine which shall be called if no ROM data is available for initialization of the NVRAM block. If a NULL pointer is configured, no specific callback routine shall be called for initialization of the NVRAM block with default data.		
<b>Multiplicity</b>	1		
<b>Type</b>	FunctionNameDef		
<b>Default value</b>	--		

<b>ConfigurationClass</b>	<b>Pre-compile time</b>	X	All Variants
	<b>Link time</b>	--	
	<b>Post-build time</b>	--	
<b>Scope / Dependency</b>	scope: module		

<b>SWS Item</b>	<b>NVM478 :</b>		
<b>Name</b>	NvmNvBlockBaseNumber {NVM_NV_BLOCK_BASE_NUMBER}		
<b>Description</b>	Configuration parameter to perform the link between the NVM_NVRAM_BLOCK_IDENTIFIER used by the SW-Cs and the FEE_BLOCK_NUMBER expected by the memory abstraction modules. The parameter relates directly to the FEE_BLOCK_NUMBER or EA_BLOCK_NUMBER with all configured NVM_DATASET_SELECTION_BITS set to zero (ref. to chapter 7.1.2.1). Calculation Formula: "value = TargetBlockReference.[Ea/Fee]BlockConfiguration.[Ea/Fee]BlockNumber"		
<b>Multiplicity</b>	1		
<b>Type</b>	DerivedIntegerParamDef		
<b>Default value</b>	--		
<b>calculationFormula</b>	--		
<b>calculationLanguage</b>	informal		
<b>ConfigurationClass</b>	<b>Pre-compile time</b>	X	All Variants
	<b>Link time</b>	--	
	<b>Post-build time</b>	--	
<b>Scope / Dependency</b>	scope: module dependency: FEE_BLOCK_NUMBER, EA_BLOCK_NUMBER		

<b>SWS Item</b>	<b>NVM479 :</b>		
<b>Name</b>	NvmNvBlockLength {NVM_NV_BLOCK_LENGTH}		
<b>Description</b>	Defines the NV block data length in bytes		
<b>Multiplicity</b>	1		
<b>Type</b>	IntegerParamDef		
<b>Range</b>	1 .. 65535		
<b>Default value</b>	--		
<b>ConfigurationClass</b>	<b>Pre-compile time</b>	X	All Variants
	<b>Link time</b>	--	
	<b>Post-build time</b>	--	
<b>Scope / Dependency</b>	scope: module		

<b>SWS Item</b>	<b>NVM480 :</b>		
<b>Name</b>	NvmNvBlockNum {NVM_NV_BLOCK_NUM}		
<b>Description</b>	Defines the number of multiple NV blocks in a contiguous area according to the given block management type. 1-255 For NVRAM blocks to be configured of block management type NVM_BLOCK_DATASET. The actual range is limited according to NVM148. 1 For NVRAM blocks to be configured of block management type NVM_BLOCK_NATIVE 2 For NVRAM blocks to be configured of block management type NVM_BLOCK_REDUNDANT		
<b>Multiplicity</b>	1		
<b>Type</b>	IntegerParamDef		
<b>Range</b>	1 .. 255		
<b>Default value</b>	--		
<b>ConfigurationClass</b>	<b>Pre-compile time</b>	X	All Variants
	<b>Link time</b>	--	



	<b>Post-build time</b>	--	
<b>Scope / Dependency</b>	scope: module dependency: NVM_BLOCK_MANAGEMENT_TYPE		

<b>SWS Item</b>	<b>NVM481 :</b>		
<b>Name</b>	NvmNvramBlockIdentifier {NVM_NVRAM_BLOCK_IDENTIFIER}		
<b>Description</b>	Identification of a NVRAM block via a unique block identifier. Implementation Type: NvM_BlockIdType. min = 0 max = 2^(16-NVM_DATASET_SELECTION_BITS)-1 Reserved NVRAM block IDs: 0 -> to derive multi block request results via NvM_GetErrorStatus 1 -> redundant NVRAM block which holds the configuration ID		
<b>Multiplicity</b>	1		
<b>Type</b>	IntegerParamDef (Symbolic Name generated for this parameter)		
<b>Default value</b>	--		
<b>ConfigurationClass</b>	<b>Pre-compile time</b>	X	All Variants
	<b>Link time</b>	--	
	<b>Post-build time</b>	--	
<b>Scope / Dependency</b>	scope: module dependency: NVM_DATASET_SELECTION_BITS		

<b>SWS Item</b>	<b>NVM035 :</b>		
<b>Name</b>	NvmNvramDeviceId {NVM_NVRAM_DEVICE_ID}		
<b>Description</b>	Defines the NVRAM device ID where the NVRAM block is located. Calculation Formula: "value = TargetBlockReference.[Ea/Fee]BlockConfiguration.[Ea/Fee]DeviceIndex"		
<b>Multiplicity</b>	1		
<b>Type</b>	DerivedIntegerParamDef		
<b>Default value</b>	--		
<b>calculationFormula</b>	--		
<b>calculationLanguage</b>	informal		
<b>ConfigurationClass</b>	<b>Pre-compile time</b>	X	All Variants
	<b>Link time</b>	--	
	<b>Post-build time</b>	--	
<b>Scope / Dependency</b>	scope: module dependency: EA_DEVICE_INDEX, FEE_DEVICE_INDEX		

<b>SWS Item</b>	<b>NVM482 :</b>		
<b>Name</b>	NvmRamBlockDataAddress {NVM_RAM_BLOCK_DATA_ADDRESS}		
<b>Description</b>	Defines the start address of the RAM block data. If a NULL pointer is configured, no permanent RAM data block is available for the selected block management type.		
<b>Multiplicity</b>	1		
<b>Type</b>	StringParamDef		
<b>Default value</b>	--		
<b>ConfigurationClass</b>	<b>Pre-compile time</b>	X	All Variants
	<b>Link time</b>	--	
	<b>Post-build time</b>	--	
<b>Scope / Dependency</b>	scope: module		

<b>SWS Item</b>	<b>NVM483 :</b>		
<b>Name</b>	NvmResistantToChangedSw {NVM_RESISTANT_TO_CHANGED_SW}		
<b>Description</b>	Defines whether a NVRAM block shall be treated resistant to configuration changes or not. If there is no default data available at configuration time then the application shall be responsible for providing the default initialization data. In this case the application has to use		

	NvM_GetErrorStatus() to be able to distinguish between first initialization and corrupted data. true: NVRAM block is resistant to changed software. false: NVRAM block is not resistant to changed software.		
<b>Multiplicity</b>	1		
<b>Type</b>	BooleanParamDef		
<b>Default value</b>	--		
<b>ConfigurationClass</b>	<b>Pre-compile time</b>	X	All Variants
	<b>Link time</b>	--	
	<b>Post-build time</b>	--	
<b>Scope / Dependency</b>	scope: module		

<b>SWS Item</b>	<b>NVM484 :</b>		
<b>Name</b>	NvmRomBlockDataAddress {NVM_ROM_BLOCK_DATA_ADDRESS}		
<b>Description</b>	Defines the start address of the ROM block data. If a NULL pointer is configured, no ROM block is available for the selected block management type.		
<b>Multiplicity</b>	1		
<b>Type</b>	StringParamDef		
<b>Default value</b>	--		
<b>ConfigurationClass</b>	<b>Pre-compile time</b>	X	All Variants
	<b>Link time</b>	--	
	<b>Post-build time</b>	--	
<b>Scope / Dependency</b>	scope: module		

<b>SWS Item</b>	<b>NVM485 :</b>		
<b>Name</b>	NvmRomBlockNum {NVM_ROM_BLOCK_NUM}		
<b>Description</b>	Defines the number of multiple ROM blocks in a contiguous area according to the given block management type. 0-255 For NVRAM blocks to be configured of block management type NVM_BLOCK_DATASET. The actual range is limited according to NVM148. 0-1 For NVRAM blocks to be configured of block management type NVM_BLOCK_NATIVE 0-1 For NVRAM blocks to be configured of block management type NVM_BLOCK_REDUNDANT		
<b>Multiplicity</b>	1		
<b>Type</b>	IntegerParamDef		
<b>Default value</b>	--		
<b>ConfigurationClass</b>	<b>Pre-compile time</b>	X	All Variants
	<b>Link time</b>	--	
	<b>Post-build time</b>	--	
<b>Scope / Dependency</b>	scope: module dependency: NVM_BLOCK_MANAGEMENT_TYPE, NVM_NV_BLOCK_NUM		

<b>SWS Item</b>	<b>NVM117, NVM245 :</b>		
<b>Name</b>	NvmSelectBlockForReadall {NVM_SELECT_BLOCK_FOR_READALL}		
<b>Description</b>	NVM117: Defines whether a NVRAM block shall be processed during NvM_ReadAll or not. This configuration parameter has only influence on those NVRAM blocks which are configured to have a permanent RAM block. NVM245: Blocks of management type NVM_BLOCK_DATASET shall not be loaded automatically upon start-up. Thus the selection of blocks, which belong to block management type NVM_BLOCK_DATASET, shall not be possible for the service NvM_ReadAll. true: NVRAM block shall be processed by NvM_ReadAll false: NVRAM block shall not be processed by NvM_ReadAll		
<b>Multiplicity</b>	1		

<b>Type</b>	BooleanParamDef		
<b>Default value</b>	--		
<b>ConfigurationClass</b>	<b>Pre-compile time</b>	X	All Variants
	<b>Link time</b>	--	
	<b>Post-build time</b>	--	
<b>Scope / Dependency</b>	scope: module dependency: NVM_RAM_BLOCK_DATA_ADDRESS		

<b>SWS Item</b>	--		
<b>Name</b>	NvmSingleBlockCallback {NVM_SINGLE_BLOCK_CALLBACK}		
<b>Description</b>	Entry address of the block specific callback routine which shall be invoked on termination of each asynchronous single block request [NVM113].		
<b>Multiplicity</b>	1		
<b>Type</b>	FunctionNameDef		
<b>Default value</b>	--		
<b>ConfigurationClass</b>	<b>Pre-compile time</b>	X	All Variants
	<b>Link time</b>	--	
	<b>Post-build time</b>	--	
<b>Scope / Dependency</b>	scope: module		

<b>SWS Item</b>	<b>NVM072 :</b>		
<b>Name</b>	NvmWriteBlockOnce {NVM_WRITE_BLOCK_ONCE}		
<b>Description</b>	Defines write protection after first write. The NVRAM manager sets the write protection bit after the NV block was written the first time. This means that some of the NV blocks in the NVRAM should never be erased nor be replaced with the default ROM data after first initialization. [NVM276]. true: Defines write protection after first write is enabled. false: Defines write protection after first write is disabled.		
<b>Multiplicity</b>	1		
<b>Type</b>	BooleanParamDef		
<b>Default value</b>	--		
<b>ConfigurationClass</b>	<b>Pre-compile time</b>	X	All Variants
	<b>Link time</b>	--	
	<b>Post-build time</b>	--	
<b>Scope / Dependency</b>	scope: module		

<b>Included Containers</b>		
<b>Container Name</b>	<b>Multiplicity</b>	<b>Scope / Dependency</b>
NvmTargetBlockReference	1	--

### 10.2.5 NvmTargetBlockReference

<b>SWS Item</b>	<b>NVM486 :</b>	
<b>Choice Container Name</b>	NvmTargetBlockReference	
<b>Description</b>	--	

<b>Container Choices</b>		
<b>Container Name</b>	<b>Multiplicity</b>	<b>Scope / Dependency</b>
NvmEaRef	0..1	EEPROM Abstraction
NvmFeeRef	0..1	Flash EEPROM Emulation

### 10.2.6 NvmEaRef

<b>SWS Item</b>	<b>NVM487 :</b>		
<b>Container Name</b>	NvmEaRef		
<b>Description</b>	EEPROM Abstraction		
<b>Configuration Parameters</b>			

<b>SWS Item</b>	<b>NVM488 :</b>		
<b>Name</b>	NvmNameOfEaBlock		
<b>Description</b>	reference to EaBlock		
<b>Multiplicity</b>	1		
<b>Type</b>	Reference to EaBlockConfiguration		
<b>ConfigurationClass</b>	<b>Pre-compile time</b>	--	
	<b>Link time</b>	--	
	<b>Post-build time</b>	--	
<b>Scope / Dependency</b>			

**No Included Containers**

### 10.2.7 NvmFeeRef

<b>SWS Item</b>	<b>NVM489 :</b>		
<b>Container Name</b>	NvmFeeRef		
<b>Description</b>	Flash EEPROM Emulation		
<b>Configuration Parameters</b>			

<b>SWS Item</b>	<b>NVM490 :</b>		
<b>Name</b>	NvmNameOfFeeBlock		
<b>Description</b>	reference to FeeBlock		
<b>Multiplicity</b>	1		
<b>Type</b>	Reference to FeeBlockConfiguration		
<b>ConfigurationClass</b>	<b>Pre-compile time</b>	--	
	<b>Link time</b>	--	
	<b>Post-build time</b>	--	
<b>Scope / Dependency</b>			

**No Included Containers**

### 10.3 Common configuration options

**NVM030:** By use of configuration techniques, each application shall be enabled to declare the memory requirements at configuration time. This information shall be useable to assign memory areas and to generate the appropriate interfaces. Wrong memory assignments and conflicts in requirements (sufficient memory not available) shall be detected at configuration time.

**NVM034:** The NVRAM memory layout configuration shall have a unique ID. The NvM module shall have a configuration identifier that is a unique property of the memory layout configuration. The ID can be either statically assigned to the configuration or it can be calculated from the configuration properties. This should be supported by a configuration tool. The ID must be changed if the block configuration changes, i.e. if a block is added or removed, or if its size or type is changed. The ID shall be stored together with the data and shall be used in addition to the data checksum to determine the consistency of the NVRAM contents.

**NVM073:** The comparison between the stored configuration ID and the compiled configuration ID shall be done as the first step within the function `NvM_ReadAll` [[NVM008](#)] during startup. In case of a detected configuration ID mismatch, the behavior of the NvM module shall be defined by a configurable option [[NVM028](#)].

**NVM052:** Provide information about used memory resources. The NvM module configuration shall provide information on how many resources of RAM, ROM and NVRAM are used. The configuration tool shall be responsible to provide detailed information about all reserved resources. The format of this information shall be commonly used (e.g. MAP file format).

#### 10.3.1 Published parameters

Published information contains data defined by the implementer of the SW module that does not change when the module is adapted (i.e. configured) to the actual HW/SW environment. It thus contains version and manufacturer information.

The standard common published information like

```
vendorId (<Module>_VENDOR_ID),  
moduleId (<Module>_MODULE_ID),  
arMajorVersion (<Module>_AR_MAJOR_VERSION),  
arMinorVersion (<Module>_AR_MINOR_VERSION),  
arPatchVersion (<Module>_AR_PATCH_VERSION),  
swMajorVersion (<Module>_SW_MAJOR_VERSION),  
swMinorVersion (<Module>_SW_MINOR_VERSION),  
swPatchVersion (<Module>_SW_PATCH_VERSION),  
vendorApiInfix (<Module>_VENDOR_API_INFIX)
```

is provided in the BSW Module Description Template (see 3.1 Figure 4.1 and Figure 7.1).

Additional published parameters are listed below if applicable for this module.

## 11 Changes to Release 1

### 11.1 Deleted SWS Items

<b>SWS Item</b>	<b>Rationale</b>
NVM002	NVRAM block management type <code>NVM_BLOCK_WALKING</code> is out of scope of the NvM module R2.0 (shifted to memory hardware abstraction).
NVM003	Specification item didn't specify any functionality.
NVM005	NVRAM block management type <code>NVM_BLOCK_WALKING</code> is out of scope of the NvM module R2.0 (shifted to memory hardware abstraction).
NVM031	Due to rejection of requirement BSW124
NVM041	Will be managed by MemHwA in R2.0
NVM043	NVRAM block management type <code>NVM_BLOCK_WALKING</code> is out of scope of the NvM module R2.0 (shifted to memory hardware abstraction).
NVM045	Specification item didn't satisfy requirement.
NVM048	NVM048 didn't add any new information to NVM047.
NVM053	NVM053 was only used as link to the block descriptor.
NVM055	NVM055 didn't add any new information to NVM032.
NVM056	<code>Std_ReturnType</code> is used instead of <code>NvM_ReturnType</code> .
NVM057	Specification item didn't satisfy requirement.
NVM058	Summarized in NVM027
NVM059	Summarized in NVM027
NVM060	Summarized in NVM027
NVM064	Standard type <code>uint8</code> is used for data sets.
NVM065	Standard type <code>Boolean</code> instead of <code>NvM_ProtectionType</code> .
NVM070	Summarized in NVM027
NVM080	Specification item was only used as a link to the input documents.
NVM081	<code>NvM_ServiceIdType</code> no more required -> Standard type is used instead
NVM082	Replaced by link to chapter 8.6.2 "Optional interfaces".
NVM090	NVM090 didn't add any new information to NVM001.
NVM093	Decision done by PL team to remove the flow charts.
NVM094	Decision done by PL team to remove the flow charts.
NVM096	Decision done by PL team to remove the flow charts.
NVM097	Decision done by PL team to remove the flow charts.
NVM098	Decision done by PL team to remove the flow charts.
NVM099	Decision done by PL team to remove the flow charts.
NVM100	Decision done by PL team to remove the flow charts.
NVM101	Decision done by PL team to remove the flow charts.
NVM102	Decision done by PL team to remove the flow charts.
NVM103	Decision done by PL team to remove the flow charts.
NVM104	Decision done by PL team to remove the flow charts.
NVM105	Decision done by PL team to remove the flow charts.
NVM108	Summarized in NVM027
NVM110	Decision done by PL team to remove the flow charts.
NVM142	RfC #14404
NVM205	RfC 17960
NVM299	RfC 17960
NVM289	RfC 17960
NVM297	RfC 17138

## 11.2 Replaced SWS Items

<b>SWS Item of Release 1</b>	<b>replaced by SWS Item</b>	<b>Rationale</b>
NVM017	<a href="#">NVM165</a>	Explicit way of data consistency/integrity check no longer available.
NVM079	<a href="#">NVM113</a> , <a href="#">NVM260</a>	

## 11.3 Changed SWS Items

<b>SWS Item</b>	<b>Rationale</b>
<a href="#">NVM008</a>	Only permanent RAM blocks can be processed automatically during start-up. Furthermore a configuration option was introduced to decide whether a permanent RAM block shall be processed or not.
<a href="#">NVM022</a>	Adaptation to new SWS template for R2.0.
<a href="#">NVM023</a>	Simplification of error possibilities.
<a href="#">NVM027</a>	All possible development errors are summarized for each API call in a global table.
<a href="#">NVM032</a>	Priority is no longer only related to write requests.
<a href="#">NVM051</a>	Change in memory hardware abstraction layer.
<a href="#">NVM061</a>	Configuration parameters added/deleted for R2.0.
<a href="#">NVM062</a>	NVM_BLOCK_WALKING and _ROM types no longer supported.
<a href="#">NVM072</a>	Configuration parameter renamed due to be more precise.
<a href="#">NVM077</a>	Optional interfaces added.
<a href="#">NVM083</a>	Simplification of possible request results.
<a href="#">NVM085</a>	Modified due to support of <code>NvmInitBlockCallback</code> configuration parameter.
NVM087	Unified behavior of <code>NvM_ReadBlock</code> and <code>NvM_ReadAll</code>
<a href="#">NVM141</a>	RfC 10970
<a href="#">NVM127</a>	RfC 10978
NVM148	RfC 10974
<a href="#">NVM027</a>	RfC 13056
<a href="#">NVM039</a>	RfC 10938
<a href="#">NVM341</a>	RfC 12253
<a href="#">NVM342</a>	RfC 12253
<a href="#">NVM279</a>	RfC 12253
<a href="#">NVM288</a>	RfC 12253
<a href="#">NVM111</a>	RfC 14701
<a href="#">NVM112</a>	RfC 14701
NVM007	RfC 14690
<a href="#">NVM028</a>	RfC 14727
<a href="#">NVM200</a>	RfC 15173
NVM251	RfC 15173
NVM276	RfC 15746
<a href="#">NVM077</a>	RfC 16572
<a href="#">NVM380</a>	RfC 44255 ECUM - NVRAM interaction during shutdown
<a href="#">NVM243</a>	RfC 44255 ECUM - NVRAM interaction during shutdown
<a href="#">NVM254</a>	RfC 44255 ECUM - NVRAM interaction during shutdown

## 11.4 Added SWS Items

<b>SWS Item</b>	<b>Rationale</b>
-----------------	------------------



NVM112	
<a href="#">NVM285</a>	Added due to adaptation to new SWS template.
<a href="#">NVM286</a>	Added due to adaptation to new SWS template.
<a href="#">NVM351</a>	RfC 13416
<a href="#">NVM352</a>	RfC 11982
<a href="#">NVM353</a>	RfC 10945
<a href="#">NVM354</a>	RfC 10954
<a href="#">NVM355</a>	RfC 10954
<a href="#">NVM356</a>	RfC 11008
<a href="#">NVM357</a>	RfC 13056
<a href="#">NVM358</a>	RfC 12253
<a href="#">NVM359</a>	RfC 12253
<a href="#">NVM360</a>	RfC 12253
<a href="#">NVM361</a>	RfC 12253
<a href="#">NVM362</a>	RfC 12458
<a href="#">NVM363</a>	RfC 12458
<a href="#">NVM364</a>	RfC 12458
<a href="#">NVM365</a>	RfC 15525
<a href="#">NVM366</a>	RfC 15173
<a href="#">NVM367</a>	RfC 15173
<a href="#">NVM368</a>	RfC 15995
<a href="#">NVM369</a>	RfC 15995
<a href="#">NVM446</a>	UML Model linking of imported types
<a href="#">NVM447</a>	UML Model linking of NvM_Init
<a href="#">NVM448</a>	UML Model linking of NvM_SetDataIndex
<a href="#">NVM449</a>	UML Model linking of NvM_GetDataIndex
<a href="#">NVM450</a>	UML Model linking of NvM_SetBlockProtection
<a href="#">NVM451</a>	UML Model linking of NvM_GetErrorStatus
<a href="#">NVM452</a>	UML Model linking of NvM_GetVersionInfo
<a href="#">NVM453</a>	UML Model linking of NvM_SetRamBlockStatus
<a href="#">NVM454</a>	UML Model linking of NvM_ReadBlock
<a href="#">NVM455</a>	UML Model linking of NvM_WriteBlock
<a href="#">NVM456</a>	UML Model linking of NvM_RestoreBlockDefaults
<a href="#">NVM457</a>	UML Model linking of NvM_EraseNvBlock
<a href="#">NVM458</a>	UML Model linking of NvM_CancelWriteAll
<a href="#">NVM459</a>	UML Model linking of NvM_InvalidateNvBlock
<a href="#">NVM460</a>	UML Model linking of NvM_ReadAll
<a href="#">NVM461</a>	UML Model linking of NvM_WriteAll
<a href="#">NVM462</a>	UML Model linking of NvM_JobEndNotification
<a href="#">NVM463</a>	UML Model linking of NvM_JobErrorNotification
<a href="#">NVM464</a>	UML Model linking of NvM_MainFunction
<a href="#">NVM465</a>	UML Model linking of mandatory interfaces
<a href="#">NVM466</a>	UML Model linking of optional interfaces
<a href="#">NVM467</a>	UML Model linking of SingleBlockCallbackFunction
<a href="#">NVM468</a>	UML Model linking of MultiBlockCallbackFunction
<a href="#">NVM469</a>	UML Model linking of InitBlockCallbackFunction
<a href="#">NVM472</a>	RfC 17133
<a href="#">NVM473</a>	RfC 17133
<a href="#">NVM474</a>	RfC 17139
NVM475	RfC 16667

## 12 Changes during SWS Improvements

### 12.1 Deleted SWS Items

<b>SWS Item</b>	<b>Rationale</b>
NVM109	Requirement on other module.
NVM159	Requirements on other modules.

### 12.2 Replaced SWS Items

<b>SWS Item of Release 1</b>	<b>replaced by SWS Item</b>	<b>Rationale</b>
NVM115	<a href="#">NVM370</a> , <a href="#">NVM371</a> , <a href="#">NVM372</a> , <a href="#">NVM373</a>	Removed requirement according to make it atomic.
NVM145	<a href="#">NVM374</a> , <a href="#">NVM375</a>	Removed requirement according to make it atomic.
NVM147	<a href="#">NVM376</a> , <a href="#">NVM377</a>	Removed requirement according to make it atomic.
NVM039	<a href="#">NVM378</a> , <a href="#">NVM379</a>	Removed requirement according to make it atomic.
NVM151	<a href="#">NVM380</a> , <a href="#">NVM381</a>	Removed requirement according to make it atomic.
NVM007	<a href="#">NVM383</a> , <a href="#">NVM384</a>	Removed requirement according to make it atomic.
NVM154	<a href="#">NVM385</a> , <a href="#">NVM386</a>	Removed requirement according to make it atomic.
NVM087	<a href="#">NVM387</a> , <a href="#">NVM388</a>	Removed requirement according to make it atomic.
NVM167	<a href="#">NVM389</a> , <a href="#">NVM390</a>	Removed requirement according to make it atomic.
NVM173	<a href="#">NVM391</a> , <a href="#">NVM392</a>	Removed requirement according to make it atomic.
NVM177	<a href="#">NVM393</a> , <a href="#">NVM394</a>	Removed requirement according to make it atomic.
NVM178	<a href="#">NVM395</a> , <a href="#">NVM396</a>	Removed requirement according to make it atomic.
NVM327	<a href="#">NVM397</a> , <a href="#">NVM398</a>	Removed requirement according to make it atomic.
NVM004	<a href="#">NVM399</a> , <a href="#">NVM400</a>	Removed requirement according to make it atomic.
NVM074	<a href="#">NVM405</a> , <a href="#">NVM406</a>	Removed requirement according to make it atomic.
NVM011	<a href="#">NVM410</a> , <a href="#">NVM411</a>	Removed requirement according to make it atomic.
NVM067	<a href="#">NVM415</a> , <a href="#">NVM416</a> , <a href="#">NVM417</a> , <a href="#">NVM418</a>	Removed requirement according to make it atomic.
NVM013	<a href="#">NVM421</a> , <a href="#">NVM422</a> , <a href="#">NVM423</a> , <a href="#">NVM424</a>	Removed requirement according to make it atomic.
NVM282	<a href="#">NVM426</a> , <a href="#">NVM427</a>	Removed requirement according to make it atomic.
NVM283	<a href="#">NVM430</a> , <a href="#">NVM431</a>	Removed requirement according to make it atomic.
NVM120	<a href="#">NVM432</a> , <a href="#">NVM433</a> ,	Removed requirement according to make it

	<a href="#">NVM434</a>	atomic.
NVM225	<a href="#">NVM435</a> , <a href="#">NVM436</a>	Removed requirement according to make it atomic.
NVM261	<a href="#">NVM438</a> , <a href="#">NVM439</a>	Removed requirement according to make it atomic.
NVM124	<a href="#">NVM442</a> , <a href="#">NVM443</a>	Original requirement was on different objects
NVM148	<a href="#">NVM444</a> , <a href="#">NVM445</a>	Original requirement was on different objects

## 12.3 Changed SWS Items

Many requirements have been changed to improve understandability.

## 12.4 Added SWS Items

<b>SWS Item</b>	<b>Rationale</b>
<a href="#">NVM401</a>	Caveat for NvM_SetDataIndex.
<a href="#">NVM402</a>	Caveat for NvM_GetDataIndex.
<a href="#">NVM403</a>	Caveat for NvM_SetBlockProtection.
<a href="#">NVM404</a>	Caveat for NvM_GetErrorStatus.
<a href="#">NVM407</a>	Caveat for NvM_SetRamBlockStatus.
<a href="#">NVM408</a>	Caveat for NvM_SetRamBlockStatus.
<a href="#">NVM409</a>	Caveat for NvM_ReadBlock.
<a href="#">NVM412</a>	Caveat for NvM_WriteBlock.
<a href="#">NVM413</a>	Caveat for NvM_ResoreBlockDefaults.
<a href="#">NVM414</a>	Caveat for NvM_EraseNvBlock
<a href="#">NVM419</a>	Caveat for NvM_CancelWriteAll.
<a href="#">NVM420</a>	Caveat for NvM_CancelWriteAll.
<a href="#">NVM425</a>	Caveat for NvM_InvalidateNvBlock
<a href="#">NVM428</a>	Caveat for NvM_ReadAll
<a href="#">NVM429</a>	Caveat for NvM_ReadAll
<a href="#">NVM437</a>	Caveat for NvM_WriteAll
<a href="#">NVM440</a>	Requirement for NvM_JobEndNotification
<a href="#">NVM441</a>	Requirement for NvM_JobErrorNotification
<a href="#">NVM446</a>	UML Model linking of imported types
<a href="#">NVM447</a>	UML Model linking of NvM_Init
<a href="#">NVM448</a>	UML Model linking of NvM_SetDataIndex
<a href="#">NVM449</a>	UML Model linking of NvM_GetDataIndex
<a href="#">NVM450</a>	UML Model linking of NvM_SetBlockProtection
<a href="#">NVM451</a>	UML Model linking of NvM_GetErrorStatus
<a href="#">NVM452</a>	UML Model linking of NvM_GetVersionInfo
<a href="#">NVM453</a>	UML Model linking of NvM_SetRamBlockStatus
<a href="#">NVM454</a>	UML Model linking of NvM_ReadBlock
<a href="#">NVM455</a>	UML Model linking of NvM_WriteBlock
<a href="#">NVM456</a>	UML Model linking of NvM_RestoreBlockDefaults
<a href="#">NVM457</a>	UML Model linking of NvM_EraseNvBlock
<a href="#">NVM458</a>	UML Model linking of NvM_CancelWriteAll
<a href="#">NVM459</a>	UML Model linking of NvM_InvalidateNvBlock
<a href="#">NVM460</a>	UML Model linking of NvM_ReadAll
<a href="#">NVM461</a>	UML Model linking of NvM_WriteAll
<a href="#">NVM462</a>	UML Model linking of NvM_JobEndNotification
<a href="#">NVM463</a>	UML Model linking of NvM_JobErrorNotification
<a href="#">NVM464</a>	UML Model linking of NvM_MainFunction

<a href="#">NVM465</a>	UML Model linking of the mandatory interfaces
<a href="#">NVM466</a>	UML Model linking of the optional interfaces
<a href="#">NVM467</a>	UML Model linking of SingleBlockCallbackFunction
<a href="#">NVM468</a>	UML Model linking of MultiBlockCallbackFunction
<a href="#">NVM469</a>	UML Model linking of InitBlockCallbackFunction
<a href="#">NVM470</a>	UML Model linking of NvM_RequestResultType
<a href="#">NVM471</a>	UML Model linking of NvM_BlockIDType

## 13 AUTOSAR Service implemented by the NVRAM Manger

### 13.1 Scope of this Chapter

This chapter is an addition to the specification of the NvM module. Whereas the other parts of the specification define the behavior and the C-interfaces of the corresponding basic software module, this chapter formally specifies the corresponding AUTOSAR Service in terms of the SWC Template. The interfaces described here will be visible on the VFB and are used to generate the RTE between application software and the NvM module.

#### 13.1.1 Package

The following definitions are interpreted to be in  
ARPackage AUTOSAR/Services/NvM

### 13.2 Overview

#### 13.2.1 Architecture

In the AUTOSAR ECU Architecture (see [1]) the NvM module implements an AUTOSAR Service as indicated in Figure 19.

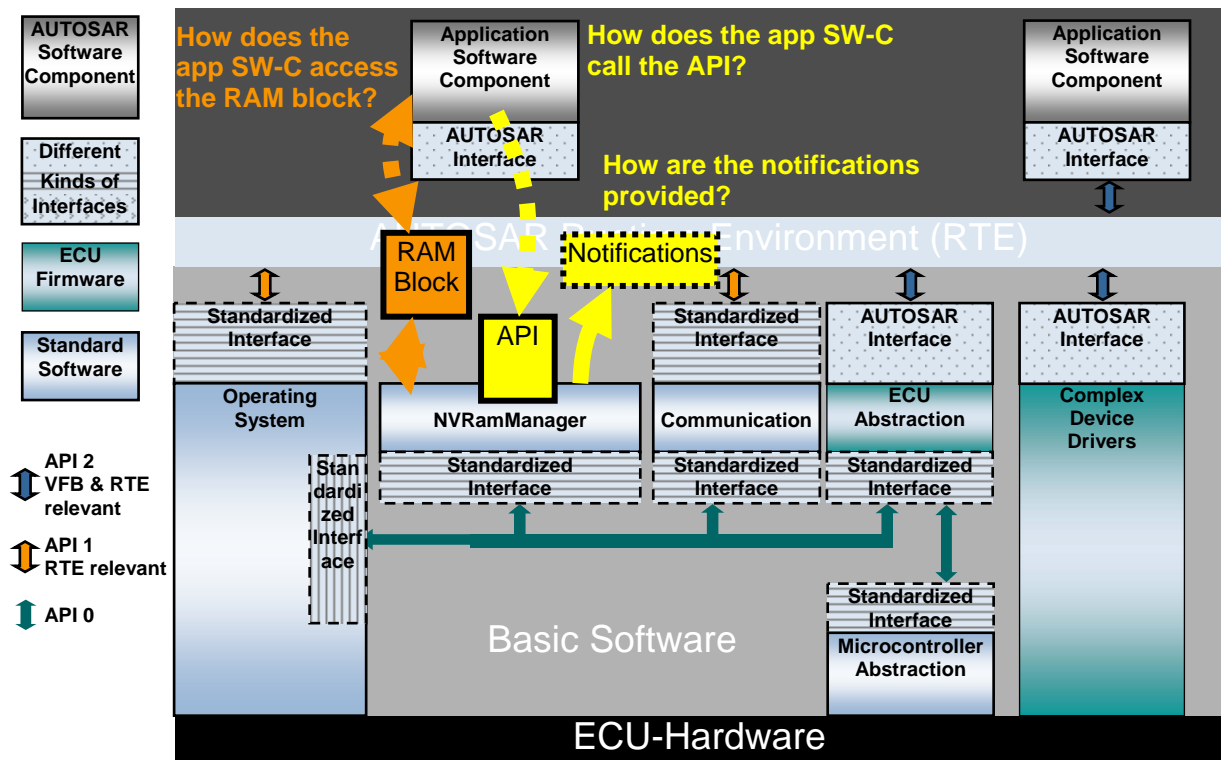

Figure 19: NVRAM Manager in ECU software architecture

From the viewpoint of the basic software C-module “NVRAM Manager”, there are three kinds of dependencies between the Service and the AUTOSAR Software Components above the RTE<sup>2</sup> :

- the application accesses the API (implemented as C-functions) of the NvM module
- the application is optionally notified upon the outcome of requested asynchronous activity (via callback-C-functions by the NvM module)
- the application accesses the RAM-blocks which the NvM module has to save or restore.

These dependencies must be described in terms of the AUTOSAR meta-model which will contribute to the SW-C Description of the application component as well as to the SW-C Description of the NVRAM Service.

### 13.2.2 Requirements

There are three sources of requirements for this specification:

- The requirements for the functionality of the NVRAM service are specified in [3].
- In order to model the VFB view of the Service, the chapter on AUTOSAR Services of the VFB specification [7] has to be considered as an additional requirement.
- For the formal description of the SW-C attributes [8] gives the requirements.

<sup>2</sup>“Applications” of the NVRAM Manager can be “below” as well as “above” the RTE; this chapter concentrates on the interfaces seen from the applications above the RTE.

### 13.2.3 Use Cases

On each ECU we have typically one instance of the NVRAM Service and several Atomic Software Component instances, named “clients” further on in this chapter, which are using this Service. In addition, there are parts of the basic software, which either control the NvM module (e.g. for initiation and shutdown) or need to read or write some NVRAM data themselves.

Each client will own certain transient data which it “wants” to make persistent via the NVRAM Service. It is important to mention that the transient data are privately owned by clients<sup>3</sup> – otherwise, the clients could communicate via the content of those data which is against AUTOSAR principles. Towards the NVRAM Service, the client uses so-called block identifiers to address the persistent data.

Furthermore, it is important that in general a client is a component *instance*. So if a client component can be instantiated more than once on an ECU, each instance will in general possess its own private copy of transient data. This is an important restriction on the modeling of block identifiers: Because for a reusable component, we cannot a priori prescribe the number of instances. We can use block identifiers (which could be in the form of symbolic information) in the code only on a per-component base, but this must result in different actual identifiers towards the NVRAM.

There are three principle ways, how a client can use the NVRAM service.

#### 13.2.3.1 Implicit Update and Restore of RAM Mirror

See Figure 20. This is a summary of use cases in which there is no communication (in the sense of the VFB) between the NvM module and its client. The client holds its transient data in a so-called RAM mirror which is organized in so-called RAM blocks permanently associated with their non-volatile counterparts of the NvM module. Update and restore of the RAM blocks is initiated by the ECU State Manager, the AUTOSAR SW-C accesses its RAM blocks directly. Note that the NvM module does NOT communicate with its client via the RAM blocks because no information is exchanged between the NvM module and its client via the RAM block.

In this case, the client does not need any AUTOSAR Interface to communicate with the Service. But nevertheless, there have to be certain contracts between the client and the NvM module:

- On the size, identification and maybe further properties of the RAM/NVRAM blocks which have to be known on both sides. For the access of the RAM mirror via the RTE see 13.4.
- On the states (of the ECU and/or the client component) in which the RAM blocks can be safely accessed by the client. For this contract, it is essential that the client is informed about its activation/termination or about the relevant ECU states. This communication path has to be handled by the RTE in cooperation with the ECU State Manager (not visible in Figure 20).

---

<sup>3</sup> If the client is an Atomic SWC. It does not hold for components of the basic SWC which might use the NVRAM Manager.

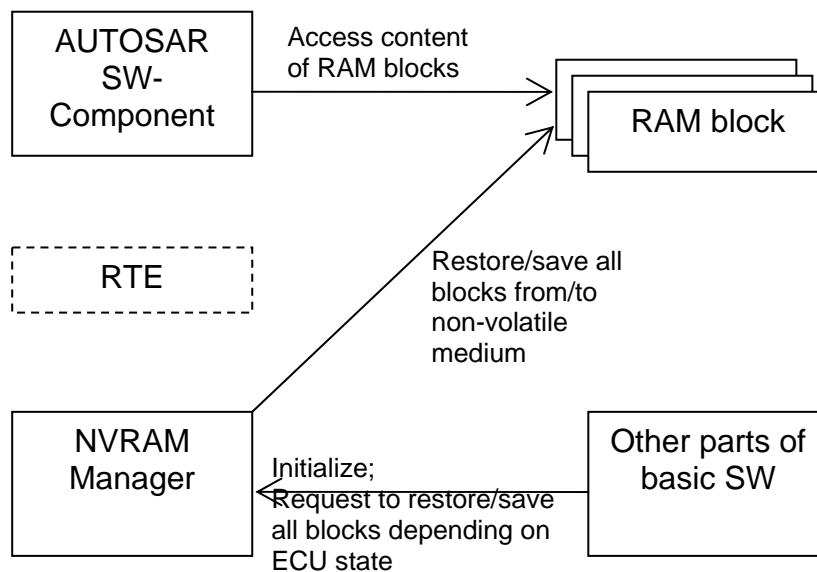

Figure 20: Implicit update/restore of RAM blocks

### 13.2.3.2 Explicit Update and Restore of RAM Mirror

See Figure 21. This is a summary of use cases in which the client explicitly requests to save or restore the content of a mirror RAM block from/to non-volatile memory (e.g. in order to decrease the risk of data loss). But as in the first case, RAM blocks are permanently associated with their counterparts in NVRAM. Now we need direct communication (in the sense of the VFB) between the NvM module and its client. Also in this case, the NvM module does NOT communicate with its client via the RAM blocks. In this case, the client must use an AUTOSAR interface to communicate with the service.

Similar to the case of implicit update/restore, we need certain contracts between the client and the NvM module:

- On the size, identification and maybe further properties of the RAM/NVRAM blocks which have to be known on both sides. For the access of the RAM mirror via the RTE see 13.4.
- On the states (of the ECU and/or the client component) in which the client may request to restore or save RAM blocks. For this contract, it is essential that the client is informed about its activation/termination or relevant ECU states. This communication path has to be handled by the RTE in cooperation with the ECU State Manager (not visible in Figure 21).
- During the explicit update and restore scenarios, the client has to follow certain rules, e.g. not to access a RAM block before the update or restore is



finished.

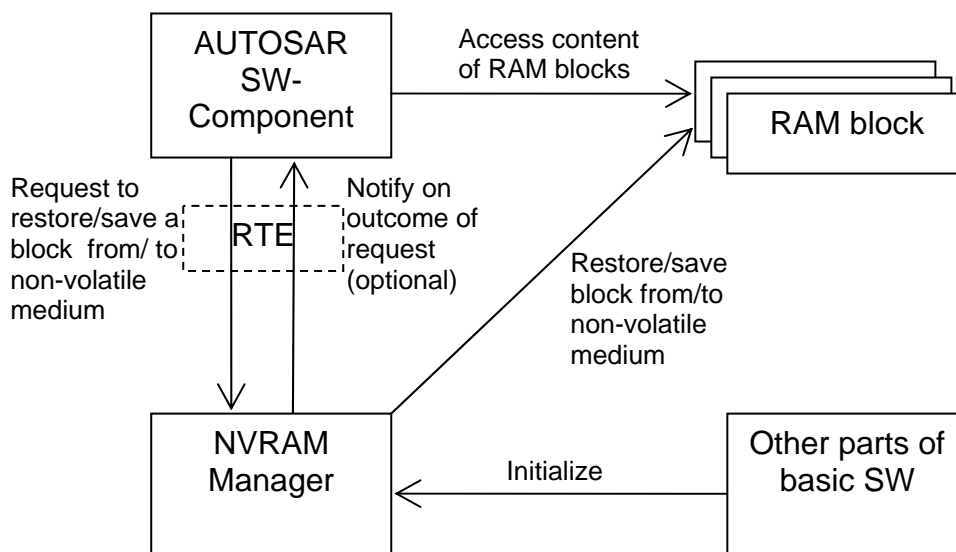

Figure 21: Explicit update/restore of mirror RAM blocks

### 13.2.3.3 Explicit Update and Restore via a Local Buffer

See Figure 22. This is a summary of use cases in which the client explicitly requests to save or restore the content of some transient data, but instead of using a RAM mirror, it passes the address of a buffer which is only temporarily associated with a certain block in NVRAM. Also, we need here direct communication (in the sense of the VFB) between the NvM module and its client. Also in this case, the NvM module does NOT communicate with its client via the RAM blocks.

Also in this case, the client must use an AUTOSAR interface to communicate with the service.

Again we need certain contracts between the client and the NvM module:

- On the size, identification and maybe further properties of the temporarily associated NVRAM blocks which have to be known on both sides. For the buffer, the partners do not have to agree on its allocation because it is totally up to the client.
- On the states (of the ECU and/or the client component) in which the client may request to restore or save RAM blocks. For this contract, it is essential that the client is informed about its activation/termination or relevant ECU states. This communication path has to be handled by the RTE in cooperation with the ECU State Manager (not visible in Figure 21).
- During the explicit update and restore scenarios, the client has to follow certain rules, e.g. not to access the buffer before the update or restore is finished.

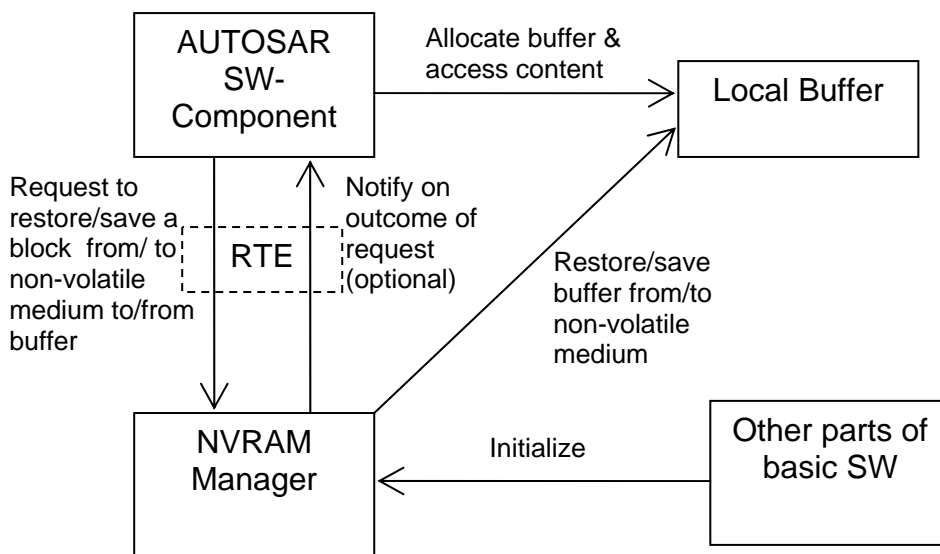

**Figure 22: Explicit update/restore of RAM blocks via buffer**

### 13.3 Specification of the Ports and Port Interfaces

This chapter specifies the ports and port interfaces which are needed in order to operate the NvM module functionality over the VFB. Note that there are ports on both sides of the RTE: The SW-C description of the NVRAM Service defines the ports below the RTE. Each SW-Component which uses the Service must contain “service ports” in its own SW-C description which are connected to the ports of the NvM module, so that the RTE can be generated.

#### 13.3.1 Ports and Port Interface for Single Block Requests

##### 13.3.1.1 General Approach

It is appropriate to model the requests issued from a client to the NVRAM Service by ports with client/server interfaces.

Typically, a client of the application domain needs the NvM module for services dealing with individual blocks (except for the simple use case described in 13.2.3.1). These so-called single block requests of the NvM module C-API need the Block ID as a first argument for the C-function.

In order to keep the client code independent from the configuration of NVRAM block IDs (which depend on the needs of all the applications on an ECU), the block IDs are not passed from the clients to the NvM module, but are modeled as “port defined argument values” of the Provide Ports on the NvM module side. As a consequence, the block IDs will not show up as arguments in the operations of the client-server interface. As a further consequence of this approach, there will be separate ports for each NVRAM block both on the client side as well as on the server side.

### 13.3.1.2 Data Types

This chapter describes the data types which will be used in the port interfaces for single block requests and notifications.

The data types `Uint8` and `Boolean` used in the interfaces refer to the basic AUTOSAR data types.

The data type `RequestResultType` indicates the result of a read or write request which are defined by the SW-C Description as follows:

```
IntegerType RequestResultType {  
    upperLimit = 0  
    lowerLimit = 5  
};
```

Via an associated `CompuMethod` the following constants are defined within this type:

```
0 -> NVM_REQ_OK  
1 -> NVM_REQ_NOT_OK  
2 -> NVM_REQ_PENDING  
3 -> NVM_INTEGRITY_FAILED  
4 -> NVM_REQ_BLOCK_SKIPPED  
5 -> NVM_REQ_NV_INVALIDATED
```

For the use cases described in chapter 13.2.3.3, we need a type `DstPtrType` to pass the address of the local buffer:

```
ArrayType DstPtrType  
{  
    elementType = Uint8;  
    maxNumberOfElements = <xx>;  
};
```

Where `<xx>` denotes the size of the used buffer, which must be equal or bigger than the size of the data block associated with the port interface in which the buffer is used.

This solution may result in slightly different interfaces if different buffer sizes are used. This is the only possibility to describe the situation in the current SWCT because it is not possible to specify a pointer type. It is assumed that for operations which can be invoked concurrently, the RTE will generate just a pointer (of type `uint*`) and allocates no additional buffer so that the resulting C-code will be as efficient as a direct function call passing a pointer.

Note that for read/write operations which do not need a local buffer, the client has to pass a zero pointer instead of the buffer address.

### 13.3.1.3 Port Interface

All single block operations (with the exception of SetBlockProtection which is **discussed** in chapter 13.3.3) are put into one single port interface in order to minimize the number of ports and names needed in the XML description.

The operations correspond to the function calls of the NVRAM C-API (notation in pseudo code; must be transferred into XML). Compared to the C-function, we do not need the "NvM\_" prefix in the names because the names given here will show up in the XML not as global entities but as part of an interface description.

The notation of possible error codes resulting from server calls follows the approach in the meta-model. It is a matter of the RTE specification [9] how those error codes will be passed via the actual API.

```
ClientServerInterface NvMService {
    PossibleErrors {
        E_NOT_OK = 1
    };

    // the next operation is always provided
    GetErrorStatus( OUT RequestResultType RequestResultPtr );

    // the next two operations are always available, but are needed
    // only for "data set" block types. Thus they shall be provided in
    // the interface only for those block types
    SetDataIndex( IN UInt8 DataIndex );
    GetDataIndex( OUT UInt8 DataIndexPtr );

    // this operation is only provided via optional configuration
    // NvmSetRamBlockStatusApi
    SetRamBlockStatus( IN Boolean BlockChanged );

    // the next three operations are only provided for
    // NVRAM API configuration class 2 and 3
    ReadBlock( IN DstPtrType DstPtr, ERR{E_NOT_OK} );
    WriteBlock( IN DstPtrType SrcPtr, ERR{E_NOT_OK} );
    RestoreBlockDefaults( IN DstPtrType DstPtr, ERR{E_NOT_OK} );

    // the next two operations are only provided for
    // NVRAM API configuration class 3
    EraseBlock( ERR{E_NOT_OK} );
    InvalidateNvBlock( ERR{E_NOT_OK} );
};
```

Note that in the interface of each Require Port of the client, only those operations must be present which the client actually requires for that block.

On the other hand, in the interface of the Provide Port, only those operations will be provided, which actually have to be configured for the NVRAM Service on a specific ECU. Because some of the operations are optional, they may not always be

provided. The optional parts are indicated by comments in the pseudo-code and must currently be configured manually in the XML Specification<sup>4</sup>.

Note that via compatibility rules, a Require Port can be connected to a Provide Port providing more operations than actually needed, but not the other way round.

Note also, that due to the optional parts, different variants of this interface may exist on the same ECU. In this case, it may be required to make the interface name unique by attaching suffixes to its name. A rule for this is however not standardized.

### 13.3.1.4 Ports

Figure 23 shows how AUTOSAR Software components (single or multiple instances) are connected by means of service ports to the NvM module.

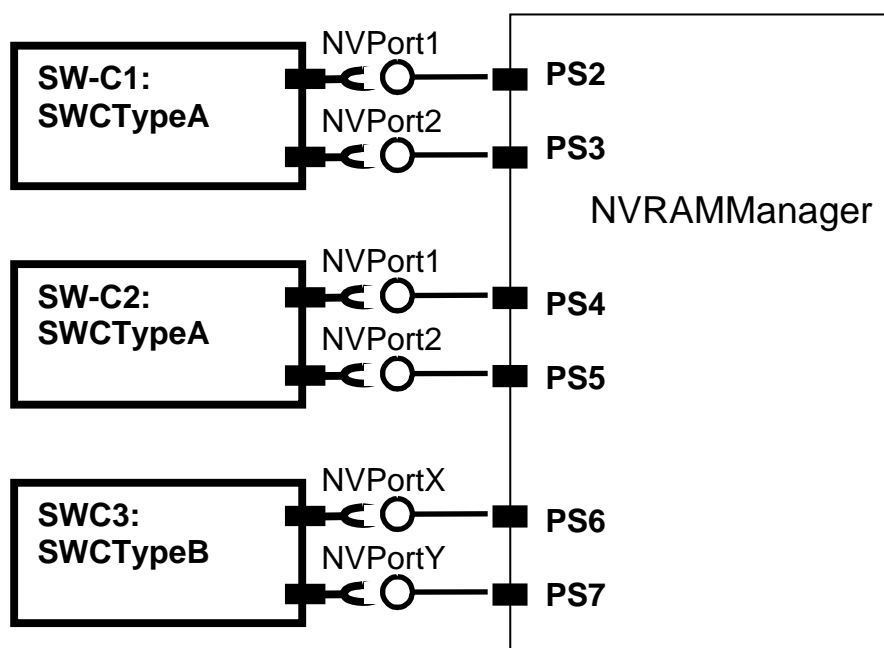

**Figure 23: Example of SW-Cs connected to the NVRAM via service ports. On the left side, there are two instances of component SWCTypeA and one instance of component SWCTypeB. The Port names on the left side are only for illustration. No notification ports or administrative ports are configured.**

On the NvM module side, there is one port per NVRAM block providing all the services of the interface `NvMService` described above. Each client has one port for requiring those services for each NVRAM block associated with that client.

The ports providing the services are named according to the `BlockID`:

`PS2, PS3, ... ,PS7`

These names are examples, they are not standardized. It is not essential, that these ports are numbered consecutively, but the numbers should match the NVRAM blocks for documentation purposes.

<sup>4</sup> By introducing a property concept in the meta-model, the optional parts may in future be controlled by other model elements. For this, the relation between the Service requirements of an SWC and the Service ports of an SWC must be explicitly modeled.

*Hint for the developers of the client components:*

There are two ways of accessing the NvM Service ports via the RTE. The selection of one alternative is an implementation decision independent of the specification of the NVRAM Service.

- 1) Use the “direct API” of the RTE. In the client code, each single block operation will show up as a separate call to the RTE which can be optimized to “zero overhead” function invocation under certain conditions (source code of the client is available and the client is a single-instance component). In case of optimization, there will be a macro for each operation and each block. Each macro will be expanded to a direct call of the NvM module.
- 2) Use the “indirect API” of the RTE. The client code will call the single block operations via a “port handle”. This port handle can be accessed by an array index which in this case identifies the NVRAM blocks used by this client. This approach offers less potential for code size optimization in the RTE, but the port handle allows for a more compact handling in the client code, e.g. if iteration over NVRAM blocks is required. Note that the ports accessed via this kind of API must have the same port interface, i.e. the optional parts must be the same.

For more explanation of the direct and indirect API see [9].

### 13.3.2 Ports and Port Interface for Notifications

Some block requests which can be initiated by client requests are performed asynchronously (with respect to the requesting call) and can be configured to throw “notifications” to indicate the completion (or error) of such a request. The reason is the relatively slow access time of the storage medium.

As a first glance a pair of request/notification looks like an asynchronous client/server communication described in [7], chapter 4.1.7.2. But it cannot be modeled that way, because in an asynchronous client/server communication, the server operation in itself is always synchronous whereas for the NvM module, the request of an action, the actual performing of it and the notification are asynchronous activities. Another reason is that the notifications are optional.

Therefore it is required to model the notification by a separate connection and thus separate ports on both service and SW component side.

The NvM module on C-code level does not pass a block ID with the callback but allows configuring a separate callback address for each block. This means that on the modeling level we need one separate (optional) notification port for each single block. As a consequence, the existence of notification ports in the SW-C Description of the NVRAM Service must be configured per ECU.

For the notification ports, a client/server interface is used, because we have to transmit two values. A drawback of this approach (in comparison to sender/receiver) is that a badly implemented SW-C could block the NvM module for an unacceptable amount of time. To minimize this risk there are two possibilities:

- Design rules for the implementation of such notifications by the SW-Cs
- Configuring the notification interface as asynchronous client/server would allow decoupling of the invocation in the SW-C from the implementation of the notification function. As this involves a more complicated protocol, this shall however be used only in special cases and is not part of the standardization of this Service.

The notification has to pass the following arguments:

- A “Service ID” which indicates which one of the asynchronous services triggered via the operations of Interface `NvMService` (see above) the notification belongs to.
- A `JobRequestResult` indicating success or failure of the service.

The Pseudo-Code for the notification interface (which has to be translated into XML) is:

```
ClientServerInterface NvMNotifyJobFinished {
    JobFinished( IN Uint8 ServiceId,
                IN RequestResultType JobResult);
};
```

The Pseudo-Code for the init block notification interface (which has to be translated into XML) is:

```
ClientServerInterface NvMNotifyInitBlock
{
    InitBlock();
};
```

It is recommended to name the ports providing the notifications via this interface according to the `BlockID` (but this is no standard), for example:

`PN2, PN3, ...`

Interrupt context: „This routine might be called in interrupt context, depending on the calling function.“ (see Chapter 0).

This requirement is consistent with current RTE requirements if the interrupt context is not propagated ”above“ the RTE. This must be handled by the RTE generation. Currently (in AUTOSAR 2.1), it is not possible to indicate this condition in the SWC Description of the Service. As a workaround, the runnable implementing the callback in the client component must be marked in this case as “`canBeInvokedConcurrently = FALSE`”. Note that this is only a workaround because this condition should be handled independently of the SWC description of the client components.

### 13.3.3 Ports and Port Interfaces for Administrative Operations

Administrative functions which are not needed for “normal” use cases are put into a separate port interface. Currently it contains only the operation “`SetBlockProtection`”.

The port interface is defined as follows. It does not specify error codes:

```
ClientServerInterface NvMAdministration {
    // the next operation is only provided for NVRAM API configuration
    // class 3; besides of that it should only be required by a client
    // for special use cases, e.g. if a block protection has to be
    // removed during initiating of EOL data
    SetBlockProtection( IN Boolean ProtectionEnabled );
};
```

For the purpose of this document, ports providing this interface have the name PAdmin<nn> for a port identifier <nn>.

### 13.3.4 Summary of all Ports

We end up with the following structure for the AUTOSAR Interface of the NvM module:

- For access from “normal” application components above the RTE:
  - For each memory block:
    - One port with a client-server interface providing all block-related services for that block (except SetBlockProtection).
    - Optional: A port with a client-server interface requiring a callback related to notifications for that block.
- For administrative purposes from above the RTE:
  - For each memory block:
    - Optional: One port with a client-server interface providing administrative services for that block

We indicate this as follows in pseudo code:



```
Service NvM
{
    // the entries in the next section will be defined only, if they
    // are actually required by client service ports
    ProvidePort NvMService PS2;
    ProvidePort NvMService PS3;
    ProvidePort NvMService PS4;
    ...
    // the entries in the next section will be defined only, if the
    // notification sinks are actually provided by client service ports
    RequirePort NvMNotify PN2;
    RequirePort NvMNotify PN3;
    RequirePort NvMNotify PN4;
    ...
    // the entries in the next section will be defined only, if they
    // are actually required by client service ports, i.e. in special
    // cases, where SetBlockProtection is needed
    ProvidePort NvMAdmin PAdmin2;
    ProvidePort NvMAdmin PAdmin3;
    ProvidePort NvMAdmin PAdmin4;
    ...
};
```

It is obvious that the existence of all these port definitions depends on the ECU. But also the port interfaces itself are in general ECU dependent because they contain optional parts as shown before. But they consist of standardized elements (operation prototypes, data types).

### 13.4 Access to the Memory Blocks

The NvM module does not specify how its clients actually access the RAM block. This is the private responsibility of each client. This especially holds **true** for the structure and semantics of the block content.

However, the current meta model allows the SW-C to specify the overall features of its NVRAM blocks (identifier, size, criticality, existence of ROM defaults etc.). For details see the specification of PortAnnotation. The NVRAM service has to be configured in response to those configurations given in the SW-C descriptions of its clients. The configuration parameters of the NVRAM Service are however more concrete (it has for example a “block management type”) whereas the SW-C template defines the requirements on such a service in a more feature-related way.

The following is only relevant if the client uses a “RAM mirror” (use cases 13.2.3.1 and 13.2.3.2): From the viewpoint of the client, each block of its RAM mirror shall be modeled as a `PerInstanceMemory`. The RTE will then handle static allocation of those memory regions. In order to get access to one of its memory blocks in RAM, the client has to use the RTE API: “`Rte_Pim`” (see [9]).

By this, the client gets a correctly typed handle to the memory section. There is no need to standardize the name of the memory section because the RTE expands it with the component and/or instance name in order to avoid name clashes.

Note the start address and size of the C data object associated with the PerlInstanceMemory sections must be harmonized with the configuration of the NVRAM block descriptors in the ECU configuration description. This issue is not part of this Specification.

### 13.5 Internal Behavior

The NvM module specification does not standardize the basic type to be used for identifying the NVRAM blocks since the needed binary size is ECU dependent. This type has to be defined for a specific ECU as follows:

```
IntegerType BlockIdType {
    lowerLimit = 2;
    upperLimit = <xx>;
};

// Where <xx> = 2^(16- NVM_DATASET_SELECTION_BITS)-1
// see NVRAM manager SWS for explanation)
```

This type does not show up in the service ports of the client components because the block identifier is implemented as port defined argument value (see chapter 13.5) which is part of the InternalBehavior of the NVRAM Service. So the ECU dependency of BlockIdType is not visible for the clients.

Values 0 and 1 have special internal meaning and must not be used as identifiers for “normal” NVRAM blocks.

The InternalBehavior of the NVRAM Service is only seen by the local RTE. Besides the definition of the block identifiers as port defined arguments, it must specify the operation invoked runnables:

```
InternalBehavior NVRAMManager {

    // definition of associated operation-invoked RTE-events not shown
    // (it is done in the same way as for any SWC type)

    // section "runnable entities":
    RunnableEntity GetErrorStatus
        symbol "NvM_GetErrorStatus"
        canbeInvokedConcurrently = TRUE

    RunnableEntity SetDataIndex
        symbol "NvM_SetDataIndex"
        canbeInvokedConcurrently = TRUE

    RunnableEntity GetDataIndex
        symbol "NvM_GetDataIndex"
        canbeInvokedConcurrently = TRUE

    RunnableEntity SetRamBlockStatus
        symbol "NvM_SetRamBlockStatus"
        canbeInvokedConcurrently = TRUE
```

```
RunnableEntity ReadBlock
    symbol "NvM_ReadBlock"
    canbeInvokedConcurrently = TRUE

RunnableEntity WriteBlock
    symbol "NvM_WriteBlock"
    canbeInvokedConcurrently = TRUE

RunnableEntity RestoreBlockDefaults
    symbol "NvM_RestoreBlockDefaults"
    canbeInvokedConcurrently = TRUE

RunnableEntity EraseNvBlock
    symbol "NvM_EraseNvBlock"
    canbeInvokedConcurrently = TRUE

RunnableEntity InvalidateNvBlock
    symbol "NvM_InvalidateNvBlock"
    canbeInvokedConcurrently = TRUE

RunnableEntity SetBlockProtection
    symbol "NvM_SetBlockProtection"
    canbeInvokedConcurrently = TRUE

// for each port providing the NvMService Interface:
PortArgument {port= PS2, value.type=BlockIdType, value.value=2}
...
PortArgument {port= PS<nn>, value.type=BlockIdType, value.value=<nn>}

// for each port providing the NvMAdministration Interface:
PortArgument {port= PAdmin<xx>, value.type=BlockIdType,
              value.value=<xx>}
...
// end of section "runnable entities"
};
```

## 13.6 Configuration of the Block IDs

The Block IDs of the NvM module are modeled as “port defined argument values”. Thus the configuration of those values is part of the input to the RTE generator. Pre-compile configuration can be done by changing the XML specification for the argument values on the NVRAM Service at ECU integration time. Note that the ports visible on the client side are not affected by this.