

Document Title	Specification of SPI Handler/Driver
Document Owner	AUTOSAR GbR
Document Responsibility	AUTOSAR GbR
Document Identification No	038
Document Classification	Standard

Document Version	2.2.0
Document Status	Final
Part of Release	3.0
Revision	0001

Document Change History			
Date	Version	Changed by	Change Description
12.12.2007	2.2.0	AUTOSAR Administration	<ul style="list-style-type: none"> • Updated Chapter 10 with the inclusion of CS configuration • Document meta information extended • Small layout adaptations made
31.01.2007	2.1.0	AUTOSAR Administration	<ul style="list-style-type: none"> • Configuration Specification updating • General rephrasing for clarification • Syntax error • Legal disclaimer revised • Release Notes added • “Advice for users” revised • “Revision Information” added
28.04.2006	2.0.0	AUTOSAR Administration	<p>Document structure adapted to common Release 2.0 SWS Template.</p> <ul style="list-style-type: none"> • Major changes in chapter 10 • Structure of document changed partly • Other changes see chapter 12
09.06.2005	1.0.0	AUTOSAR Administration	Initial Release

Page left intentionally blank

Disclaimer

Any use of these specifications requires membership within the AUTOSAR Development Partnership or an agreement with the AUTOSAR Development Partnership. The AUTOSAR Development Partnership will not be liable for any use of these specifications.

Following the completion of the development of the AUTOSAR specifications commercial exploitation licenses will be made available to end users by way of written License Agreement only.

No part of this publication may be reproduced or utilized in any form or by any means, electronic or mechanical, including photocopying and microfilm, without permission in writing from the publisher.

The word AUTOSAR and the AUTOSAR logo are registered trademarks.

Copyright © 2004-2007 AUTOSAR Development Partnership. All rights reserved.

Advice to users of AUTOSAR Specification Documents:

AUTOSAR Specification Documents may contain exemplary items (exemplary reference models, "use cases", and/or references to exemplary technical solutions, devices, processes or software).

Any such exemplary items are contained in the Specification Documents for illustration purposes only, and they themselves are not part of the AUTOSAR Standard. Neither their presence in such Specification Documents, nor any later documentation of AUTOSAR conformance of products actually implementing such exemplary items, imply that intellectual property rights covering such exemplary items are licensed under the same rules as applicable to the AUTOSAR Standard.

Table of Contents

1	Introduction and functional overview	7
2	Acronyms and abbreviations	8
3	Related documentation.....	9
3.1	Input documents.....	9
3.2	Related standards and norms	10
4	Constraints and assumptions	10
4.1	Limitations	10
4.2	Applicability to car domains.....	10
5	Dependencies to other modules.....	11
5.1	File structure	11
5.1.1	Code file structure	11
5.1.2	Header file structure.....	12
6	Requirements traceability	13
7	Functional specification	20
7.1	Overall view of functionalities and features	20
7.2	General behaviour.....	21
7.2.1	Common configurable feature: Allowed Channel Buffers.....	23
7.2.1.1	Behaviour of IB channels	23
7.2.1.2	Behaviour of EB channels.....	24
7.2.1.3	Buffering channel usage	24
7.2.2	LEVEL 0, Simple Synchronous behaviour	24
7.2.3	LEVEL 1, Basic Asynchronous behavior	25
7.2.4	Asynchronous configurable feature: Interruptible Sequences	27
7.2.4.1	Behavior of Non-Interruptible Sequences	27
7.2.4.2	Behavior of Mixed Sequences	27
7.2.5	LEVEL 2, Enhanced behaviour	28
7.3	Scheduling Advices	29
7.4	Error classification	29
7.5	Error detection.....	30
7.5.1	API parameter checking.....	30
7.5.2	SPI state checking	31
7.6	Error notification	31
7.7	Version check.....	31
8	API specification.....	32
8.1	Imported types.....	32
8.2	Type definitions	32
8.2.1	Spi_ConfigType.....	32
8.2.2	Spi_StatusType.....	33
8.2.3	Spi_JobResultType	33
8.2.4	Spi_SeqResultType	34
8.2.5	Spi_DataType	34
8.2.6	Spi_NumberOfDataType.....	34

8.2.7	Spi_ChannelType.....	34
8.2.8	Spi_JobType	35
8.2.9	Spi_SequenceType	35
8.2.10	Spi_HWUnitType.....	35
8.2.11	Spi_AsyncModeType	35
8.3	Function definitions	36
8.3.1	Spi_Init	36
8.3.2	Spi_DeInit	37
8.3.3	Spi_WriteIB	37
8.3.4	Spi_AsyncTransmit	38
8.3.5	Spi_ReadIB	39
8.3.6	Spi_SetupEB.....	40
8.3.7	Spi_GetStatus	42
8.3.8	Spi_GetJobResult	42
8.3.9	Spi_GetSequenceResult.....	43
8.3.10	Spi_GetVersionInfo	43
8.3.11	Spi_SyncTransmit.....	44
8.3.12	Spi_GetHWUnitStatus.....	45
8.3.13	Spi_Cancel.....	45
8.3.14	Spi_SetAsyncMode.....	46
8.4	Callback notifications.....	48
8.5	Scheduled functions	48
8.5.1	Spi_MainFunction_Handling	48
8.5.2	Spi_MainFunction_Driving	48
8.6	Expected Interfaces.....	48
8.6.1	Mandatory Interfaces	48
8.6.2	Optional Interfaces	49
8.6.3	Configurable interfaces	49
8.6.3.1	Spi_JobEndNotification	50
8.6.3.2	Spi_SeqEndNotification	50
9	Sequence diagrams	51
9.1	Initialization	51
9.2	Modes transitions	51
9.3	Write/AsyncTransmit/Read (IB).....	51
9.3.1	One Channel, one Job then one Sequence	51
9.3.2	Many Channels, one Job then one Sequence.....	53
9.3.3	Many Channels, many Jobs and one Sequence	54
9.3.4	Many Channels, many Jobs and many Sequences	56
9.4	Setup/AsyncTransmit (EB)	58
9.4.1	Variable Number of Data / Constant Number of Data	58
9.4.2	One Channel, one Job then one Sequence	58
9.4.3	Many Channels, one Job then one Sequence.....	60
9.4.4	Many Channels, many Jobs and one Sequence	61
9.4.5	Many Channels, many Jobs and many Sequences	63
9.5	Mixed Jobs Transmission	65
9.6	LEVEL 0 SyncTransmit diagrams.....	66
9.6.1	Write/SyncTransmit/Read (IB): Many Channels, many Jobs and one Sequence	66

9.6.2	Setup/SyncTransmit (EB): Many Channels, many Jobs and one Sequence	67
10	Configuration specification	69
10.1	How to read this chapter	69
10.1.1	Configuration and configuration parameters	69
10.1.2	Containers	69
10.1.3	Specification template for configuration parameters	69
10.2	Containers and configuration parameters	71
10.2.1	Variants	71
10.2.2	SpiDriver	79
10.3	Published parameters	81
10.4	Configuration concept	82
11	Appendix	83
12	Changes to Release 1	85
12.1	Deleted SWS Items	85
12.2	Replaced SWS Items	85
12.3	Changed SWS Items	85
12.4	Added SWS Items	85
13	Changes during SWS Improvements by Technical Office	88
13.1	Deleted SWS Items	88
13.2	Replaced SWS Items	88
13.3	Changed SWS Items	88
13.4	Added SWS Items	88

1 Introduction and functional overview

The SPI Handler/Driver provides services for reading from and writing to devices connected via SPI busses. It provides access to SPI communication to several users (e.g. EEPROM, Watchdog, I/O ASICs). It also provides the required mechanism to configure the onchip SPI peripheral.

This specification describes the API for a monolithic SPI Handler/Driver. This software module includes handling and driving functionalities. Main objectives of this monolithic SPI Handler/Driver are to take the best of each microcontroller features and to allow implementation optimization depending on static configuration to fit as much as possible to ECU needs.

SPI107: Hence, this specification defines selectable levels of functionalities and configurable features to allow the design of a high scalable module that exploits the peculiarities of the microcontroller.

To configure the SPI Handler/Driver these steps shall be followed:

- SPI Handler/Driver Level of Functionality shall be selected and optional features configured.
- SPI Channels shall be defined according to data usage, and they could be buffered inside the SPI Handler/Driver (IB) or provided by the user (EB).
- SPI Jobs shall be defined according to HW properties (CS), and they will contain a list of channels using those properties.
- As a final step, Sequences of Jobs shall be defined, in order to transmit data in a sorted way (priority sorted).

The general behaviour of the SPI Handler/Driver can be asynchronous or synchronous according to the Level of Functionality selected.

The specification covers the Handler/Driver functionality combined in one single module. One is the SPI handling part that handles multiple access to busses that could be located in the ECU Abstraction layer. The other part is the SPI driver that accesses the microcontroller hardware directly that could be located in the Microcontroller Abstraction layer.

2 Acronyms and abbreviations

Acronyms and abbreviations which have a local scope and therefore are not contained in the AUTOSAR glossary must appear in a local glossary.

Acronym:	Description:
DET	Development Error Tracer – module to which development errors are reported.
DEM	Diagnostic Event Manager – module to which production relevant errors are reported.
SPI	Serial Peripheral Interface. It is exactly defined hereafter in this document.
CS	Chip Select
MISO	Master Input Slave Output
MOSI	Master Output Slave Input

Abbreviation:	Description:
EB	Externally buffered channels. Buffers containing data to transfer are outside the SPI Handler/Driver.
IB	Internally buffered channels. Buffers containing data to transfer are inside the SPI Handler/Driver.
ID	Identification Number of an element (Channel, Job, Sequence).

Definition:	Description:
Channel	A Channel is a software exchange medium for data that are defined with the same criteria: Config. Parameters, Number of Data elements with same size and data pointers (Source & Destination) or location.
Job	A Job is composed of one or several Channels with the same Chip Select (is not released during the processing of Job). A Job is considered atomic and therefore cannot be interrupted by another Job. A Job has an assigned priority.
Sequence	A Sequence is a number of consecutive Jobs to transmit but it can be rescheduled between Jobs using a priority mechanism. A Sequence transmission is interruptible (by another Sequence transmission) or not depending on a static configuration.

3 Related documentation

3.1 Input documents

- [1] Layered Software Architecture
https://svn2.autosar.org/repos2/22_Releases
AUTOSAR_LayeredSoftwareArchitecture.pdf
- [2] General Requirements on SPAL
https://svn2.autosar.org/repos2/22_Releases
AUTOSAR_SRS_SPAL_General.pdf
- [3] General Requirements on Basic Software Modules
https://svn2.autosar.org/repos2/22_Releases
AUTOSAR_SRS_General.pdf
- [4] Specification of Development Error Tracer
https://svn2.autosar.org/repos2/22_Releases
AUTOSAR_SWS_DevelopmentErrorTracer.pdf
- [5] Specification of ECU Configuration
https://svn2.autosar.org/repos2/22_Releases
AUTOSAR_ECU_Configuration.pdf
- [6] Requirements on SPI Handler/Driver
https://svn2.autosar.org/repos2/22_Releases
AUTOSAR_SRS_SPI_HandlerDriver.pdf
- [7] Specification of Diagnostics Event Manager
https://svn2.autosar.org/repos2/22_Releases
AUTOSAR_SWS_DEM.pdf
- [8] Glossary
https://svn2.autosar.org/repos2/22_Releases
AUTOSAR_Glossary.pdf
- [9] Specification of MCU Driver
https://svn2.autosar.org/repos2/22_Releases
AUTOSAR_SWS_MCU_Driver .pdf
- [10] Specification of PORT Driver
https://svn2.autosar.org/repos2/22_Releases
AUTOSAR_SWS_PORT_Driver
- [11] AUTOSAR Basic Software Module Description Template,
https://svn2.autosar.org/repos2/22_Releases/
AUTOSAR_BSW_Module_Description.pdf

3.2 Related standards and norms

Not related.

4 Constraints and assumptions

4.1 Limitations

SPI040: The SPI Handler/Driver handles only the Master mode.

SPI050: The SPI Handler/Driver only supports full-duplex mode.

SPI108: The LEVEL 2 SPI Handler/Driver is specified for microcontrollers that have to provide, at least, two SPI busses using separated hardware units. Otherwise, using this level of functionality does not make sense.

4.2 Applicability to car domains

No restrictions.

5 Dependencies to other modules

SPI peripherals may depend on the system clock, prescaler(s) and PLL. Thus, changes of the system clock (e.g. PLL on → PLL off) may also affect the clock settings of the SPI hardware. The SPI Handler/Driver module does not take care of setting the registers which configure the clock, prescaler(s) and PLL in its init function. This has to be done by the MCU module 0.

Depending on microcontrollers, the SPI peripheral could share registers with other peripherals. In this typical case, the SPI Handler/Driver has a relationship with MCU module 0 for initialising and de-initialising those registers.

If Chip Selects are done using microcontroller pins the SPI Handler/Driver has a relationship with PORT module [10]. In this case, this specification assumes that these microcontroller pins are directly accessed by the SPI Handler/Driver module without using APIs of DIO module. Anyhow, the SPI depends on ECU hardware design and for that reason it may depend on other modules.

5.1 File structure

5.1.1 Code file structure

SPI095: The code file structure shall not be defined within this specification completely. At this point it shall be pointed out that the code-file structure shall include the following file named:

- Spi_Lcfg.c – for link time and for post-build configurable parameters and
- Spi_PBcfg.c – for post build time configurable parameters.

These files shall contain all link time and post-build time configurable parameters.

5.1.2 Header file structure

SPI092: The SPI module shall adhere to the following include file structure:

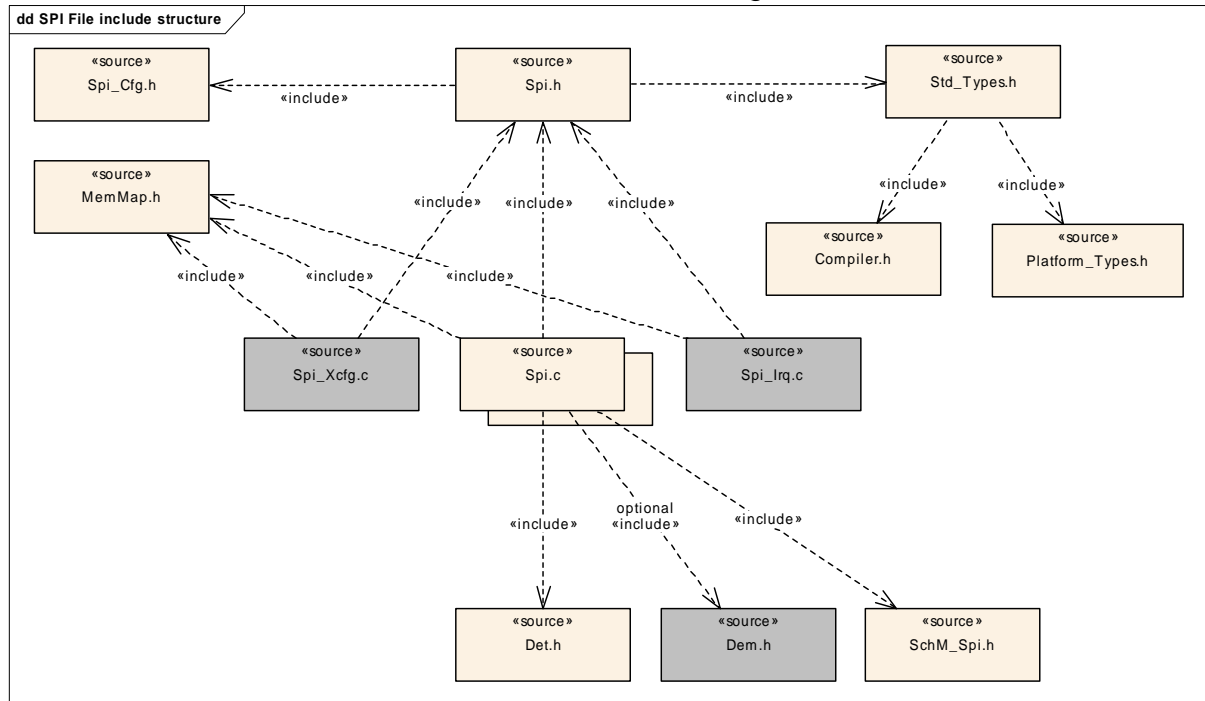

- Spi.c shall include Spi.h
- Spi_Xcfg.c shall include Spi.h
- Spi.h shall include Spi_Cfg.h
- Spi_Irq.c this file could exist depending of implementation and also it could or not include Spi.h

SPI158: The SPI module shall optionally include the Dem.h file if any production error will be issued by the implemetation. By this inclusion the APIs to report errors as well as the required Event Id symbols are included.

SPI159: The DEM configuration tool shall assign ECU dependent values to the Event Id symbols and publish the symbols in Dem_IntErrId.h.

The names of the Event Id symbols which are provided by XML to the DEM configuration tool are specified in this document.

6 Requirements traceability

Document: AUTOSAR requirements on Basic Software, general

Requirement	Satisfied by
[BSW003] Version identification	SPI068 SPI089 SPI094
[BSW00300] Module naming convention	Chapter 5.1
[BSW00301] Limit imported information	Not applicable (requirement on implementation, not on specification)
[BSW00302] Limit exported information	Not applicable (requirement on implementation, not on specification)
[BSW00304] AUTOSAR integer data types	Chapters 5.1.2, 8.2, 10.2 and 10.3
[BSW00305] Self-defined data types naming convention	Chapter 8.2
[BSW00306] Avoid direct use of compiler and platform specific keywords	Not applicable (requirement on implementation, not on specification)
[BSW00307] Global variables naming convention	Not applicable (requirement on implementation, not on specification)
[BSW00308] Definition of global data	Not applicable (requirement on implementation, not on specification)
[BSW00309] Global data with read-only constraint	Not applicable (requirement on implementation, not on specification)
[BSW00310] API naming convention	Chapter 8.3
[BSW00312] Shared code shall be reentrant	Not applicable (requirement on implementation, not on specification)
[BSW00314] Separation of interrupt frames and service routines	Chapter 5.1
[BSW00318] Format of module version numbers	SPI094
[BSW00321] Enumeration of module version numbers	SPI094
[BSW00323] API parameter checking	SPI029 SPI031 SPI032 SPI060
[BSW00324] Do not use HIS I/O Library	Not applicable (requirement on AUTOSAR architecture, not a single module)
[BSW00325] Runtime of interrupt service routines	Not applicable (Cannot be detailed at this point of time, because this depends on module implementation.)
[BSW00326] Transition from ISRs to OS tasks	Not applicable (Cannot be detailed at this point of time, because this depends on module implementation.)
[BSW00327] Error values naming convention	SPI004
[BSW00328] Avoid duplication of code	Not applicable (requirement on implementation, not on specification)
[BSW00329] Avoidance of generic interfaces	Chapter 8
[BSW00330] Usage of macros / inline functions instead of functions	Not applicable (requirement on implementation, not on specification)
[BSW00331] Separation of error and status values	Not applicable (requirement on implementation, not on specification)

[BSW00333] Documentation of callback function context	Chapters 8.6.3.1 and 8.6.3.2
[BSW00334] Provision of XML file	Not applicable (requirement on implementation, not on specification)
[BSW00335] Status values naming convention	SPI061 SPI062 SPI019
[BSW00336] Shutdown interface	SPI021 SPI022
[BSW00337] Classification of errors	SPI004 SPI007 SPI097 SPI098
[BSW00338] Reporting of development errors	SPI100
[BSW00339] Reporting of production relevant error status	SPI006 SPI099 and Chapter 8.6.2
[BSW00341] Microcontroller compatibility documentation	Not applicable (requirement on implementation, not on specification)
[BSW00342] Usage of source code and object code	Not applicable (requirement on implementation, not on specification)
[BSW00343] Specification and configuration of time	Not applicable (requirement on implementation, not on specification)
[BSW00344] Reference to link-time configuration	SPI009 SPI091
[BSW00345] Pre-compile-time configuration	SPI056
[BSW00347] Naming separation of different instances of BSW drivers	Not applicable (requirement on implementation, not on specification)
[BSW00348] Standard type header	Chapter 8.1
[BSW00350] Development error detection keywords	SPI005 SPI103 SPI056
[BSW00353] Platform specific type header	Chapter 8.1
[BSW00355] Do not redefine AUTOSAR integer data types	Not applicable (requirement on implementation, not on specification)
[BSW00357] Standard API return type	SPI174 Chapter 8.3
[BSW00358] Return type of init() functions	Chapter 8.3.1
[BSW00359] Return type of callback functions	SPI048
[BSW00360] Parameters of callback functions	SPI048
[BSW00361] Compiler specific language extension header	Chapter 5.1.2
[BSW00369] Do not return development error codes via API	SPI005 SPI029 SPI048 SPI006
[BSW00370] Separation of callback interface from API	Chapter 8.4
[BSW00371] Do not pass function pointers via API	Chapters 8.6.3, 10.2
[BSW00373] Main processing function naming convention	Chapter 8.5
[BSW00374] Module vendor identification	SPI068 SPI089 SPI094
[BSW00375] Notification of wake-up reason	Not applicable. (Only master mode is supported. Master mode does not provide wake up events.)
[BSW00376] Return type and parameters of main processing functions	Chapter 8.5
[BSW00377] Module specific API return types	Chapters 0, 8.2.3 and 8.2.4
[BSW00378] AUTOSAR boolean type	SPI105
[BSW00379] Module identification	SPI068 SPI089 SPI094
[BSW00380] Separate C-Files for configuration parameters	SPI095
[BSW00381] Separate configuration header file for pre-compile time parameters	SPI103

[BSW00383] List dependencies of configuration files	Chapter 5
[BSW00384] List dependencies to other modules	Chapter 5, SPI158 SPI159
[BSW00385] List possible error notifications	SPI004 SPI007
[BSW00386] Configuration for detecting an error	SPI005 SPI029
[BSW00387] Specify the configuration class of callback function	Chapters 8.4 and 8.6.3
[BSW00388] Introduce containers	SPI103 SPI091 SPI104 SPI105 SPI106
[BSW00389] Containers shall have names	SPI103 SPI091 SPI104 SPI105 SPI106
[BSW00390] Parameter content shall be unique within the module	SPI103 SPI091 SPI104 SPI105 SPI106 SPI094
[BSW00391] Parameter shall have unique names	SPI103 SPI091 SPI104 SPI105 SPI106 SPI094
[BSW00392] Parameters shall have a type	SPI103 SPI091 SPI104 SPI105 SPI106
[BSW00393] Parameters shall have a range	SPI103 SPI091 SPI104 SPI105 SPI106
[BSW00394] Specify the scope of the parameters	SPI103 SPI091 SPI104 SPI105 SPI106
[BSW00395] List the required parameters (per parameter)	SPI103 SPI091 SPI104 SPI105 SPI106
[BSW00396] Configuration classes	SPI056 SPI076 SPI103 SPI091 SPI104 SPI105 SPI106
[BSW00397] Pre-compile-time parameters	SPI056 SPI103
[BSW00398] Link-time parameters	SPI076 SPI091 SPI104 SPI105 SPI106
[BSW00399] Loadable Post-build time parameters	Non applicable (Cannot be detailed at this point of time, because this depends on ECU integration.)
[BSW004] Version check	SPI069
[BSW00400] Selectable Post-build time parameters	Non applicable (Cannot be detailed at this point of time, because this depends on ECU integration.)
[BSW00401] Documentation of multiple instances of configuration parameters	Not applicable (requirement on implementation, not on specification)
[BSW00402] Published information	SPI068 SPI089 SPI094
[BSW00404] Reference to post build time configuration	SPI148
[BSW00405] Reference to multiple configuration sets	SPI008 SPI013 SPI076 SPI148
[BSW00406] Check module initialization	SPI015 SPI046
[BSW00407] Function to read out published parameters	SPI101 SPI102
[BSW00408] Configuration parameter naming convention	Chapter 10.2
[BSW00409] Header files for production code error IDs	SPI097
[BSW00410] Compiler switches shall have defined values	SPI103
[BSW00411] Get version info keyword	SPI102
[BSW00412] Separate H-File for configuration parameters	SPI092
[BSW00413] Accessing instances of BSW modules	Not applicable (requirement on implementation, not on specification)
[BSW00414] Parameter of init function	Chapter 8.3.1
[BSW00415] User dependent include files	SPI092
[BSW00416] Sequence of Initialization	Not applicable (this is a general software integration requirement)
[BSW00417] Reporting of Error Events by Non-Basic Software	Not applicable (applies only for non BSW modules)
[BSW00419] Separate C-Files for pre-compile time configuration parameters	SPI095

[BSW00420] Production relevant error event rate detection	Not applicable (applies only for DEM)
[BSW00421] Reporting of production relevant error events	SPI006 SPI099 and Chapter 8.6.2
[BSW00422] Debouncing of production relevant error status	Not applicable (applies only for DEM)
[BSW00423] Usage of SW-C template to describe BSW modules with AUTOSAR Interfaces	Not applicable (EEPROM driver has no Autosar Interface)
[BSW00424] BSW main processing function task allocation	Not applicable (this is a general software integration requirement)
[BSW00425] Trigger conditions for schedulable objects	Chapter 8.5
[BSW00426] Exclusive areas in BSW modules	Not applicable (Cannot be detailed at this point of time, because this depends on module implementation.)
[BSW00427] ISR description for BSW modules	Not applicable (Cannot be detailed at this point of time, because this depends on module implementation.)
[BSW00428] Execution order dependencies of main processing functions	Not applicable (Cannot be detailed at this point of time, because this depends on module implementation.)
[BSW00429] Restricted BSW OS functionality access	Not applicable (requirement on implementation, not on specification)
[BSW00431] The BSW Scheduler module implements task bodies	Not applicable (SPI Handler/Driver Module is not the BSW Scheduler)
[BSW00432] Modules should have separate main processing functions for read/receive and write/transmit data path	Not applicable (requirement on implementation, not on specification)
[BSW00433] Calling of main processing functions	Not applicable (this is a general software integration requirement)
[BSW00434] The Schedule Module shall provide an API for exclusive areas	Not applicable (SPI Handler/Driver Module is not the BSW Scheduler)
[BSW00435] Module Header File Structure for the Basic Software Scheduler	SPI092
[BSW00436] Module Header File Structure for the Memory Mapping	SPI092
[BSW005] No hard coded horizontal interfaces within MCAL	Not applicable (requirement on AUTOSAR architecture, not a single module)
[BSW006] Platform independency	Not applicable (requirement on implementation, not on specification)
[BSW007] HIS MISRA C	Not applicable (requirement on implementation, not on specification)
[BSW009] Module User Documentation	Not applicable (requirement on implementation, not on specification)
[BSW010] Memory resource documentation	Not applicable (requirement on implementation, not on specification)
[BSW101] Initialization interface	SPI013 SPI015

[BSW158] Separation of configuration from implementation	SPI103 SPI091 SPI089 SPI095
[BSW159] Tool-based configuration	Both static and runtime configuration parameters are located outside the source code of the module. This is the prerequisite for automatic configuration.
[BSW160] Human-readable configuration data	Requirement on configuration methodology and tools
[BSW161] Microcontroller abstraction	Not applicable (requirement on AUTOSAR architecture, not a single module)
[BSW162] ECU layout abstraction	Not applicable (requirement on AUTOSAR architecture, not a single module)
[BSW164] Implementation of interrupt service routines	Not applicable (Cannot be detailed at this point of time, because this depends on module implementation.)
[BSW167] Static configuration checking	Requirement on configuration tool
[BSW168] Diagnostic Interface of SW components	Not applicable (no use case)
[BSW170] Data for reconfiguration of AUTOSAR SW-Components	Not applicable (requirement on SW Component)
[BSW171] Configurability of optional functionality	Conflicts partly with SPAL requirement [BSW12263] Configuration after compile time.
[BSW172] Compatibility and documentation of scheduling strategy	Not applicable (requirement on implementation, not on specification)

Document: AUTOSAR requirements on Basic Software, cluster SPAL

Requirement	Satisfied by
[BSW12263] Object code compatible configuration concept	SPI076
[BSW12056] Configuration of notification mechanisms	SPI009 SPI064 SPI044 SPI054
[BSW12267] Configuration of wake-up sources	Not applicable. (Only master mode is supported. Master mode does not provide wake up events.)
[BSW12057] Driver module initialization	SPI013 SPI015
[BSW12125] Initialization of hardware resources	SPI013 SPI008 SPI009
[BSW12163] Driver module deinitialization	SPI021 SPI022
[BSW12461] Responsibility for register initialization	See chapter 5
[BSW12462] Provide settings for register initialization	Cannot be detailed at this point of time, because this depends on SPI hardware and implementation.
[BSW12463] Combine and forward settings for register initialization	Cannot be detailed at this point of time (see above)
[BSW12068] MCAL initialization sequence	Not applicable (this is a general software integration requirement)
[BSW12069] Wake-up notification of ECU State Manager	Not applicable (the SPI does not cause any wake-ups)
[BSW157] Notification mechanisms of drivers and handlers	SPI026 SPI038 SPI039 SPI042 SPI057 SPI071 SPI073 SPI075
[BSW12169] Control of operation mode	Chapter 9.2
[BSW12063] Raw value mode	Not applicable (no I/O functionality)
[BSW12075] Use of application buffers	SPI053

[BSW12129] Resetting of interrupt flags	No Applicable to the Handler API but shall be define for the Driver API.
[BSW12064] Change of operation mode during running operation	Chapter 9.2, SPI025 SPI021
[BSW12448] Behavior after development error detection	Chapters 7.5.1 and 7.5.2
[BSW12067] Setting of wake-up conditions	Not applicable (the SPI resource does not cause any wake-ups)
[BSW12077] Non-blocking implementation	Not applicable (requirement on implementation, not on specification)
[BSW12078] Runtime and memory efficiency	Not applicable (requirement on implementation, not on specification)
[BSW12092] Access to drivers	Not applicable (requirement on implementation, not on specification)
[BSW12265] Configuration data shall be kept constant	Not applicable (requirement on implementation, not on specification)
[BSW12264] Specification of configuration items	Chapter 10.2

Document: AUTOSAR requirements on Basic Software, SPI Handler/Driver

Requirement	Satisfied by
[BSW12093] SPI Channel support	SPI009 SPI010 SPI034 SPI041
[BSW12094] Chip select	SPI009 SPI066
[BSW12256] Support of all Controller Peripherals	SPI008 SPI009 SPI034
[BSW12257] Support of chained HW devices	SPI008 SPI063 SPI009 SPI010 SPI034 SPI065 SPI066
[BSW13400] Scalable functionality	SPI107 SPI110 Chapters 7.2.1 and 7.2.4
[BSW12025] Configuration of SPI general SW and HW properties	SPI008 SPI009 SPI063 SPI052 SPI053
[BSW12179] SPI Channel linkage	SPI009 SPI003 SPI064 SPI065
[BSW12026] Assignment of SPI Channel to SPI HW Unit	SPI009
[BSW12197] Definition of data width	SPI063
[BSW13401] Statically configurable functionalities	SPI109 SPI111 SPI121 SPI122 SPI125
[BSW12258] Data shall be accessible device individually	SPI003 SPI065 SPI009
[BSW12259] Support of different timing and HW parameters	SPI009
[BSW12260] Support of different priorities of sequences	SPI009 SPI064 SPI002 SPI014 SPI059 SPI093
[BSW12180] Handling of single SPI channels	SPI003 SPI065
[BSW12181] Handling of linked SPI channels	SPI065 SPI055
[BSW12032] Chip select mode – normal mode	SPI009 SPI066
[BSW12033] Chip select mode – hold mode	SPI009 SPI066
[BSW12198] Transfer one short data sequence with variable data	SPI053 SPI077
[BSW12253] Transfer one short data sequence with constant data	SPI052 SPI078
[BSW12199] Transfer data to several devices in one Sequence	SPI065 SPI003 SPI064
[BSW12200] Read large data sequences from one slave device using dummy send data	SPI053 SPI065 SPI003 SPI035 SPI077
[BSW12261] Read large data sequences from	SPI053 SPI065 SPI003

one slave device using variable send data	
[BSW12201] Read large data sequences from several slave devices using dummy send data	SPI065 SPI003 SPI035 SPI077
[BSW12262] Read large data sequences from several slave devices using variable send data	SPI053 SPI065 SPI003 SPI078
[BSW12202] Support of variable data length	SPI053 SPI078
[BSW12024] Configuration of SPI HW Unit	SPI008 SPI063
[BSW12150] Configuration of SPI asynchronous SW and HW properties	SPI009 SPI064 SPI093
[BSW12108] Callback notification	Chapter 8.6.3 SPI057 SPI118 SPI119 SPI120
[BSW12099] Asynchronous Read Functionality	SPI020 SPI162 SPI163 SPI016 SPI020
[BSW12101] Asynchronous Write Functionality	SPI020 SPI162 SPI163 SPI018 SPI020
[BSW12103] Asynchronous Read-Write Functionality	SPI020 SPI053 SPI058 SPI067
[BSW12037] Job Management Strategy – Priority controlled	Chapter 7.2.3, 7.2.4 and 7.3 SPI014 SPI059 SPI124 SPI127
[BSW12104] SPI status functionality	SPI025 SPI026 SPI039
[BSW12170] Concurrent Channel access	SPI042 SPI084
[BSW12152] Synchronous Read Function	Chapter 7.2.2 SPI134 SPI016
[BSW12153] Synchronous Write Function	Chapter 7.2.2 SPI134 SPI018
[BSW12154] Synchronous Write-Read Function	Chapter 7.2.2 SPI134
[BSW12151] Job Management Strategy – Order of requests	Chapter 7.2.2

7 Functional specification

The SPI (Serial Peripheral Interface) has a 4-wire synchronous serial interface. Data communication is enabled with a Chip select wire (CS). Data is transmitted with a 3-wire interface consisting of wires for serial data output (MOSI), serial data input (MISO) and serial clock (CLOCK).

7.1 Overall view of functionalities and features

This specification is based on previous specification experiences and also based on predominant identified use cases. The intention of this section is to summarize how the scalability of this monolithic SPI Handler/Driver allows getting a simple software module that fits simple needs up to a smart software module that fits enhanced needs.

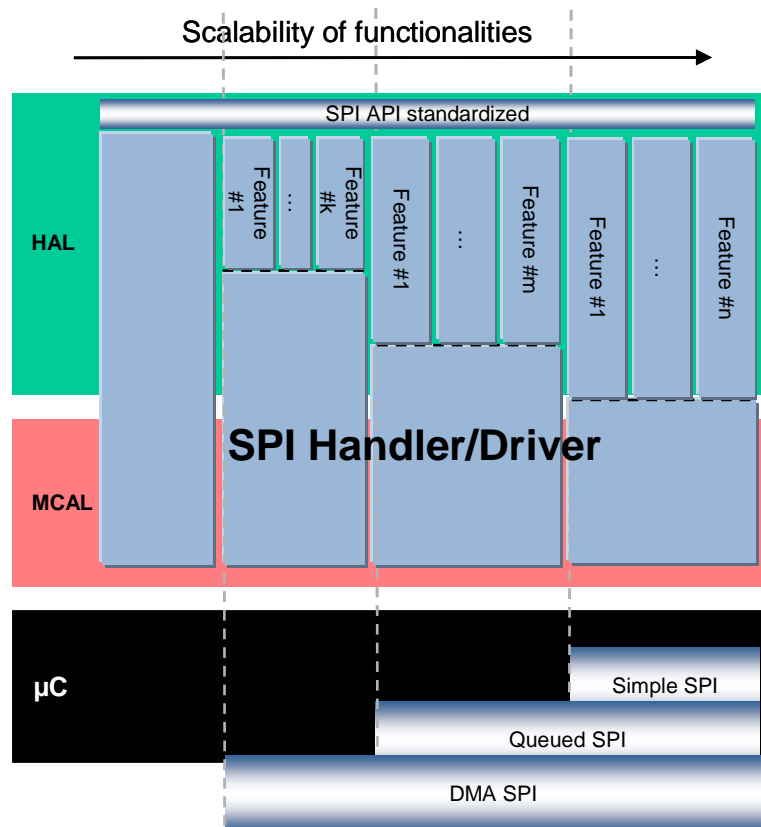

This document specifies the following 3 Levels of Scalable Functionality for the SPI Handler/Driver:

- LEVEL 0, **Simple Synchronous SPI Handler/Driver**: the communication is based on synchronous handling with a FIFO policy to handle multiple accesses. Buffer usage is configurable to optimize and/or to take advantage of HW capabilities.

- LEVEL 1, **Basic Asynchronous SPI Handler/Driver**: the communication is based on asynchronous behavior and with a Priority policy to handle multiple accesses. Buffer usage is configurable as for “Simple Synchronous” level.
- LEVEL 2, **Enhanced (Synchronous/Asynchronous) SPI Handler/Driver**: the communication is based on asynchronous behavior or synchronous handling, using either interrupts or polling mechanism selectable during execution time and with a Priority policy to handle multiple accesses. Buffer usage is configurable as for other levels.

SPI109: The SPI Handler/Driver’s level of scalable functionality shall always be statically configurable, i.e. configured at pre-compile time to allow the best source code optimisation.

SPI110: The `SpiLevelDelivered` parameter shall be configured with one of the 3 authorized values according to the described levels (0, 1 or 2) to allow the selection of the SPI Handler/Driver’s level of scalable functionality.

To improve the scalability, each level has optional features which are configurable (ON / OFF) or selectable. These are described in detail in the dedicated chapters.

7.2 General behaviour

This chapter, on the one hand, introduces common behavior and configuration for all levels. On the other, it specifies the behavior of each level and also the allowed optional features.

SPI041: The SPI Handler/Driver interface configuration shall be based on Channels, Jobs and Sequences as defined in this document (see chapter 2).

SPI034: The SPI Handler/Driver shall support one or more Channels, Jobs and Sequences to drive all kind of SPI compatible HW devices. Data transmissions shall be done according to Channels, Jobs and Sequences configuration parameters.

SPI066: The Chip Select (CS) is attached to the Job definition. Chip Select shall be handled during Job transmission and shall be released at the end of it¹. This Chip Select handling shall be done according to the Job configuration parameters.

Example of CS handling: Set the CS active at the beginning of Job transmission; maintain it until the end of transmission of all Channels belonging to this Job afterwards set the CS inactive.

A Channel is defined one time but it could belong to several Jobs according to the user needs and this software specification.

¹ The software implementation to handle CS depends on several parameters such as microcontroller capabilities and/or ECU hardware design. For this reason, the specification does not specify how to do it but only how to configure a CS reference to a Job.

SPI065: A Job shall contain at least one Channel. If it contains more than one, all Channels contained have the same Job properties during transmission and shall be linked together statically.

A Job is defined one time but it could belong to several Sequences according to the user needs and this software specification.

SPI003: A Sequence shall contain at least one Job. If it contains more than one, all Jobs contained have the same Sequence properties during transmission and shall be linked together statically.

A Channel used for a transmission should have its parameters configured but it is allowed to pass Null pointers as source and destination pointers to generate a dummy transmission (See also [\[SPI028\]](#) & [\[SPI030\]](#)).

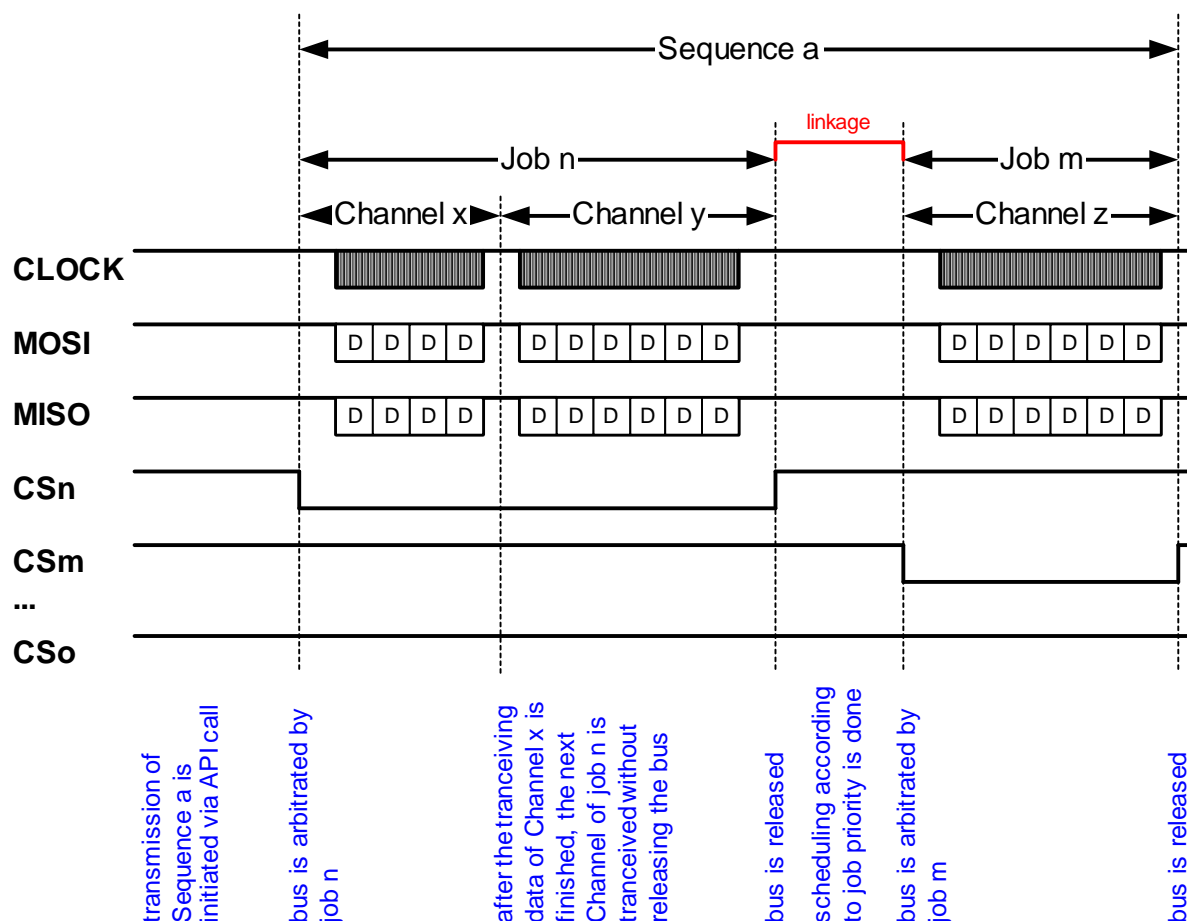

Channel data may differ from the hardware handled and user (client application) given. On the client side the data is handled in 8, 16 or 32bits mode (see chapter 8.2.5). On the microcontroller side, the hardware may handle between 1 and 32bits or may handle a fixed value (8 or 16bits) and this width is configurable for each Channel (see `SpiDataWidth`).

SPI149: The SPI Handler/Driver shall take care of the differences between the width of channel data handled by the user and those handled by the hardware by applying the following rules:

- Spi_DataType 8/16/32 bits, data width 8/16/32 bits: Straightforward send and receive.
- Spi_DataType superior to data width: Send the lower part, ignore the upper part. Receive the lower part, extend with zero.
- Spi_DataType inferior to data width: According to the memory alignment use prior both rules.

This ensures that the user always gets the same interface.

7.2.1 Common configurable feature: Allowed Channel Buffers

In order to allow taking advantages of all microcontroller capabilities but also to allow sending/receiving of data to/from a dedicated memory location, all levels have an optional feature with respect to the location of Channel Buffers.

Hence, two main kinds of channel buffering can be used by configuration:

- Internally buffered Channels (IB): The buffer to transmit/receive data is provided by the Handler/Driver.
- Externally buffered Channels (EB): The buffer to transmit/receive is provided by the user (statically and/or dynamically).

Both channel buffering methods may be used depending on the 3 use cases described below:

- Usage 0: the SPI Handler/Driver manages only Internal Buffers.
- Usage 1: the SPI Handler/Driver manages only External Buffers.
- Usage 2: the SPI Handler/Driver manages both buffers types.

SPI111: The `SpiChannelBuffersAllowed` parameter shall be configured with one of the 3 authorized values according to the described usage (0, 1 or 2) to select which Channel Buffers the SPI Handler/Driver manages.

7.2.1.1 Behaviour of IB channels

The intention of Internal Buffer channels is to take advantage of microcontrollers including this feature by hardware. Otherwise, this feature should be simulated by software.

SPI052: For the IB Channels, the Handler/Driver shall provide the buffering but it is not able to take care of the consistency of the data in the buffer during transmission. The size of the Channel buffer is fixed.

SPI049: The channel data received shall be stored in 1 entry deep internal buffers by channel. The SPI Handler/Driver shall not take care of the overwriting of these “receive” buffers by another transmission on the same channel.

SPI051: The channel data to be transmitted shall be copied in 1 entry deep internal buffers by channel. The SPI Handler/Driver is not able to prevent the overwriting of these “transmit” buffers by users during transmissions, see [\[SPI084\]](#).

7.2.1.2 Behaviour of EB channels

The intention of External Buffer channels is to reuse existing buffers that are located outside. That means the SPI Handler/Driver does not monitor them.

SPI053: For EB Channels the application shall provide the buffering and shall take care of the consistency of the data in the buffer during transmission.

SPI112: The size of the Channel buffer is either fixed or variable. A maximum size for the Channel buffer shall be defined by the configuration but the buffer really provided by the application may have a different size.

7.2.1.3 Buffering channel usage

The following table provides information about the Channel characteristics:

<i>IB Channels</i>	
It provides...	<ul style="list-style-type: none"> • A more abstracted concept (buffering mechanisms are hidden) • Actual and future optimal implementation taken profit of HW buffer facilities (Given size of 256 bytes covers nowadays requirements).
Suggested use ...	<ul style="list-style-type: none"> • Daisy-chain implementation. • Small data transfer devices (up to 10 Bytes).
<i>EB Channels</i>	
It provides...	<ul style="list-style-type: none"> • Efficient mechanism to support large stream communication. • Send constant data out of ROM tables and spare RAM size. • Send various data tables each for a different device (highly complex ASICS with several integrated peripheral devices, also mixed signal types, could exceed IB HW buffer size)
Suggested use ...	<ul style="list-style-type: none"> • Large streams communication. • EEPROM communication. • Control of complex HW Chips .

7.2.2 LEVEL 0, Simple Synchronous behaviour

The intention of this functionality level is to provide a Handler/Driver with a reduced set of services to handle only simple synchronous transmissions. This is often the case for ECU including simple SPI networks but also for ECU using high speed external devices.

A simple synchronous transmission means that the user calling the transmission service is blocked during the ongoing transmission.

SPI160: The LEVEL 0 SPI Handler/Driver shall offer a synchronous transfer service for SPI busses.

SPI161: For an SPI Handler/Driver operating in LEVEL 0, when there is no on-going Sequence transmission, the SPI Handler/Driver shall be in the idle state (`SPI_IDLE`).

This monolithic SPI Handler/Driver is able to handle one to n SPI busses according to the microcontroller used. Then SPI busses are assigned to Jobs and not to Sequences. Consequently, Jobs, on different SPI busses, could belong to the same Sequence. Therefore:

SPI114: The LEVEL 0 SPI Handler/Driver shall not allow transmitting more than one Sequence at the same time. That means during a Sequence on-going transmission, all requests to transmit another Sequence shall be rejected.

SPI115: The LEVEL 0 SPI Handler/Driver behaviour shall include the common feature: Allowed Channel Buffers, which is selected.

SPI084: If different Jobs (and consequently also Sequences) have common Channels, the SPI Handler/Driver' environment shall ensure that read and/or write functions are not called during transmission.

Read and write functions can not guarantee the data integrity while Channel data is being transmitted.

7.2.3 LEVEL 1, Basic Asynchronous behavior

The intention of this functionality level is to provide a Handler/Driver with a reduced set of services to handle asynchronous transmissions only. This is often the case for ECU with functions related to SPI networks having different priorities but also for ECU using low speed external devices.

An asynchronous transmission means that the user calling the transmission service is not blocked when the transmission is on-going. Furthermore, the user can be notified at the end of transmission².

SPI162: The LEVEL 1 SPI Handler/Driver shall offer an asynchronous transfer service for SPI busses.

SPI163: For an SPI Handler/Driver operating in LEVEL 01, when there is no on-going Sequence transmission, the SPI Handler/Driver shall be in the idle state (`SPI_IDLE`).

This Handler/Driver will be used by several software modules which may be independent from each other and also may belong to different layers. Therefore, priorities will be assigned to Jobs in order to figure out specific cases of multiple accesses. These cases usually occur within real time systems based on asynchronous mechanisms.

SPI002: Jobs have priorities assigned. Jobs linked in a Sequence shall have decreasing priorities. That means the first Job shall have the highest priority of all Jobs within the Sequence.

² This basic asynchronous behaviour might be implemented either by using interrupt or by polling mechanism. This software design choice is not in the scope of this document, but only solution is required for the LEVEL 1.

SPI093: Priority order of jobs shall be from the lower to the higher value defined, higher value higher priority (from 0, the lower to 3, the higher, limited to 4 priority levels see [SPI009]).

With reference to Jobs priorities, this Handler/Driver needs rules to make a decision in these specific cases of multiple accesses.

SPI059: The SPI Handler/Driver scheduling method shall schedule Jobs in order to send the highest priority Job first.

This monolithic SPI Handler/Driver is able to handle one to n SPI busses according to the microcontroller used. But SPI busses are assigned to Jobs and not to Sequences. Consequently, Jobs on different SPI busses could belong to the same Sequence. Therefore:

SPI116: The LEVEL 1 SPI Handler/Driver may allow transmitting more than one Sequence at the same time. That means during a Sequence transmission, all requests to transmit another Sequence shall be evaluated in order to accept to start a new sequence or to reject it accordingly to the lead Job.

SPI117: The LEVEL 1 SPI Handler/Driver behaviour shall include the common feature: Allowed Channel Buffers, which is selected, and the configured asynchronous feature: Interruptible Sequence (see next chapter).

SPI083: When a hardware error is detected, the SPI Handler/Driver shall stop the current Sequence, report an error to the error hook of the DET or to the DEM as configured³ and set the state of the Job to `SPI_JOB_FAILED` and the state of the Sequence to `SPI_SEQ_FAILED`.

SPI118: If Jobs and Sequences are configured with a specific end notification function, the SPI Handler/Driver shall call this notification function at the end of the Job/Sequence transmission (see [SPI071] & [SPI073]).

SPI119: When a valid notification function pointer is configured (see [SPI071]), the SPI Handler/Driver shall call this notification function at the end of a Job transmission regardless of the result of the Job transmission being either `SPI_JOB_FAILED` or `SPI_JOB_OK` (rational: avoid deadlocks or endless loops).

SPI120: When a valid notification function pointer is configured (see [SPI073]), the SPI Handler/Driver shall call this notification function at the end of a Sequence transmission regardless of the result of the Sequence transmission being either `SPI_SEQ_FAILED`, `SPI_SEQ_OK` or `SPI_SEQ_CANCELLED` (rational: avoid deadlocks or endless loops).

³ Implementation and hardware capabilities related errors are specified in this document, Production errors could be defined later during the software design stage.

7.2.4 Asynchronous configurable feature: Interruptible Sequences

In order to allow taking advantages of asynchronous transmission mechanism, level 1 and level 2 of this SPI Handler/Driver have an optional feature with respect to suspending the transmission of Sequences.

Hence two main kinds of sequences can be used by configuration:

- Non-Interruptible Sequences, every Sequence transmission started is not suspended by the Handler/Driver until the end of transmission.
- Mixed Sequences, according to its configuration, a Sequence transmission started may be suspended by the Handler/Driver between two of their consecutive Jobs.

SPI121: The SPI Handler/Driver's environment shall configure the `SpiInterruptibleSeqAllowed` parameter (ON / OFF) in order to select which kind of Sequences the SPI Handler/Driver manages.

7.2.4.1 Behavior of Non-Interruptible Sequences

The intention of the Non-Interruptible Sequences feature is to provide a simple software module based on a basic asynchronous mechanism, if only non blocking transmissions should be used.

SPI122: Interruptible Sequences are not allowed within levels 1 and 2 of the SPI/Handler/Driver: the `SpiInterruptibleSeqAllowed` parameter is switched off (i.e. configured with value "OFF").

SPI123: When the SPI Handler/Driver is configured not allowing ininterruptible Sequences, all Sequences declared are considered as Non-Interruptible Sequences. That means, their dedicated parameter `SpiInterruptibleSequence` (see [SPI064](#) & [SPI106](#)) can be omitted or the `FALSE` value should be used as default⁴.

SPI124: According to [[SPI116](#)] and [[SPI122](#)] requirements, the SPI Handler/Driver is not allowed to suspend a Sequence transmission already started in favour of another Sequence.

7.2.4.2 Behavior of Mixed Sequences

The intention of the Mixed Sequences feature is to provide a software module with specific asynchronous mechanisms, if, for instance, very long Sequences that could or should be suspended by others with higher priority are used.

⁴ The intention of this requirement is not to enforce any implementation solution in comparison with another one. But, it is only to ensure that anyhow, all Sequences will be considered as Non Interruptible Sequences.

SPI125: Interruptible Sequences are allowed within levels 1 and 2 of SPI Handler/Driver: the `SpiInterruptibleSeqAllowed` parameter is switched on (i.e. configured with value "ON").

SPI126: When the SPI Handler/Driver is configured allowing interruptible Sequences, all Sequences declared shall have their dedicated parameter `SpiInterruptibleSequence` (see [SPI064](#) & [SPI106](#)) to identify whether the Sequence can be suspended during transmission.

SPI014: In case of a Sequence configured as Interruptible Sequence and according to [\[SPI125\]](#) requirement, the SPI Handler/Driver is allowed to suspend an already started Sequence transmission in favour of another Sequence with a higher priority Job (see [SPI002](#) & [SPI093](#)). That means, at the end of a Job transmission (that belongs to the interruptible sequence) with another Sequence transmit request pending, the SPI Handler/Driver shall perform a rescheduling in order to elect the next Job to transmit.

SPI127: In case of a Sequence configured as Non-Interruptible Sequence and according to requirement [\[SPI125\]](#), the SPI Handler/Driver is not allowed to suspend this already started Sequence transmission in favour of another Sequence.

SPI080: When using Interruptible Sequences, the caller must be aware that if the multiple Sequences access the same Channels, the data for these Channels may be overwritten by the highest priority Job accessing each Channel.

7.2.5 LEVEL 2, Enhanced behaviour

The intention of this functionality level is to provide a Handler/Driver with a complete set of services to handle synchronous and asynchronous transmissions. This could be the case for ECU with a lot of functions related to SPI networks having different priorities but also for ECU using external devices with different speeds.

Handling asynchronous and synchronous transmissions means that the microcontroller for which this software module is dedicated has to provide more than one SPI bus (see [\[SPI108\]](#)). In fact, the goal is to support SPI buses using a so-called synchronous driver and to support other SPI buses using a so-called asynchronous driver.

SPI128: The LEVEL 2 SPI Handler/Driver shall offer a synchronous transfer service for a dedicated SPI bus and it shall also offer an asynchronous transfer service for other SPI busses. When there is no on-going Sequence transmission, the SPI Handler/Driver shall be in idle state (`SPI_IDLE`).

SPI129: The SPI bus dedicated for synchronous transfers is prearranged. This information shall be published by the supplier of this software module (see [\[SPI094\]](#)).

This functionality level, based on a mixed usage of synchronous transmission on one prearranged SPI bus and asynchronous transmission on others, generates restrictions on configuration and usage of Sequences and Jobs.

SPI130: The so-called synchronous Sequences shall only be composed of Jobs that are associated to the prearranged SPI bus (see [SPI094]). These Sequences shall be used with synchronous services⁵ only.

SPI131: Jobs associated with the prearranged SPI bus (see [SPI094]) shall not belong to Sequences containing Jobs associated with another SPI bus. In other words, mixed Sequences (synchronous with asynchronous Jobs) shall not be allowed.

Usually, depending on software design, asynchronous end transmission may be detected by polling or interrupt mechanisms. This level of functionality proposes both mechanisms that are selectable during execution time.

SPI155: The SPI Handler/Driver LEVEL 2 shall implement one polling mechanism mode and one interrupt mechanism mode for SPI busses handled asynchronously.

SPI156: Both the polling mechanism and interrupt mechanism modes for SPI busses shall be selectable during execution time (see [SPI188]).

SPI132: The requirements for LEVEL 0 applies to synchronous behaviour and the requirements for LEVEL 1 applies to asynchronous behaviour.

7.3 Scheduling Advices

For asynchronous levels, LEVEL 1 and LEVEL 2, the SPI Handler/Driver can call end notification functions at the end of a Job and/or Sequence transmission (see [SPI118]). In a second time, in case of interruptible Sequences (that could be suspended), if another Sequence transmit request is pending, a rescheduling is also done by the SPI Handler/Driver in order to elect the next Job to transmit (see [SPI014]).

SPI088: In case these two actions are fully done by software; the order between these shall be first scheduling and then the call of end notification function. Otherwise, if they are done by hardware and the order could not be configured as required, the order shall be completely documented.

7.4 Error classification

SPI004: Depending on its build version (development/production mode), the SPI Handler/driver shall be able to detect the errors listed in the table below:

Type or error	Relevance	Related error code	Value(hex)
API service called with wrong parameter	Development	SPI_E_PARAM_CHANNEL	0x0A
		SPI_E_PARAM_JOB	0x0B
		SPI_E_PARAM_SEQ	0x0C
		SPI_E_PARAM_LENGTH	0x0D

⁵ The second part of this requirement is aim at SPI Handler/Driver users. But, it is up to the software module supplier to implement mechanisms in order to prevent potential misuses by users.

		SPI_E_PARAM_UNIT	0x0E
API service used without module initialization	Development	SPI_E_UNINIT	0x1A
Services called in a wrong sequence	Development	SPI_E_SEQ_PENDING	0x2A
Synchronous transmission service called at wrong time	Development	SPI_E_SEQ_IN_PROCESS	0x3A
API SPI_Init service called while the SPI driver has already been initialized	Development	SPI_E_ALREADY_INITIALIZED	0x4A

SPI097: Values for production code Event Ids are assigned externally by the configuration of the Dem. They are published in the file Dem_IntErrId.h and included via Dem.h.

SPI007: Additional errors that are detected because of specific implementation and/or specific hardware properties shall be added to the SPI device specific implementation description. The classification and enumeration shall be compatible to the errors listed above [SPI004].

SPI098: Development error values are of type `uint8`.

7.5 Error detection

SPI005: The detection of all development errors is configurable (On / Off) at pre-compile time. The switch `SpiDevErrorDetect` (see chapter 10) shall activate or deactivate the detection of all development errors.

SPI029: If the switch `SpiDevErrorDetect` is enabled API parameter checking is also enabled. The detailed description of the detected errors can be found in chapter 7.5.1.

SPI099: The detection of production code errors cannot be switched off.

7.5.1 API parameter checking

SPI031: The API parameter `Channel` shall have a value within the defined channels in the initialization data structure, and the correct type of channel (IB or EB) has to be used with services. Related error value: `SPI_E_PARAM_CHANNEL`. Otherwise, the service is not done and the return value shall be `E_NOT_OK`.

SPI032: The API parameters `Sequence` and `Job` shall have values within the specified range of values. Related errors values: `SPI_E_PARAM_SEQ` or `SPI_E_PARAM_JOB`. Otherwise, the service is not done and, depending on services, either the return value shall be `E_NOT_OK` or a failed result (`SPI_JOB_FAILED` or `SPI_SEQ_FAILED`).

SPI060: The API parameter `Length` of data shall have a value within the specified buffer maximum values (see SPI063). Related error value: `SPI_E_PARAM_LENGTH`. Otherwise, the service is not done and the return value shall be `E_NOT_OK`.

SPI143: The API parameter `HWUnit` shall have a value within the specified range of values. Related error value: `SPI_E_PARAM_UNIT`. Otherwise, the service is not done and the return value shall be `SPI_UNINIT`.

7.5.2 SPI state checking

SPI046: If the SPI Handler/Driver's environment calls any API function before initialization, an error should be reported to the DET with the error value `SPI_E_UNINIT` according to the configuration (see chapter 7.5). In this case, the SPI Handler/Driver shall not process the invoked function but, depending on the invoked function, shall either return the value `E_NOT_OK` or a failed result (`SPI_JOB_FAILED` or `SPI_SEQ_FAILED`).

SPI233: The calling of the routine `SPI_Init()` while the SPI driver is already initialized will cause a development error `SPI_E_ALREADY_INITIALIZED` and the desired functionality shall be left without any action.

7.6 Error notification

SPI100: Detected development errors shall be reported to the error hook of the Development Error Tracer (DET) if the pre-processor switch `SpidevErrorDetect` is set (see chapter 10).

SPI006: Production relevant errors shall be reported to the Diagnostic Event Manager (DEM). They shall not be used as the return value of the called function.

7.7 Version check

SPI069: `spi.c` shall check if the correct version of `spi.h` is included. This shall be done by a pre-processor check.

8 API specification

8.1 Imported types

In this chapter all types included from the following files are listed:

SPI174:

Header file	Imported Type
Dem_Types.h	Dem_EventIdType
Std_Types.h	Std_VersionInfoType
	Std_ReturnType

8.2 Type definitions

8.2.1 Spi_ConfigType

Name:	Spi_ConfigType	
Type:	Structure	
Range:	Implementation Specific	The contents of the initialization data structure are SPI specific.
Description:	This type of the external data structure shall contain the initialization data for the SPI Handler/Driver.	

SPI008: The type `Spi_ConfigType` is an external data structure and shall contain the initialization data for the SPI Handler/Driver. It shall contain:

- MCU dependent properties for SPI HW units
- Definition of Channels
- Definition of Jobs
- Definition of Sequences

SPI063: For the type `Spi_ConfigType`, the definition for each Channel shall contain:

- Buffer usage with EB/IB Channel
- Transmit data width (1 up to 32 bits)
- Number of data buffers for IB Channels (at least 1) or it is the maximum of data for EB Channels (a value of 0 makes no sense)
- Transfer start LSB or MSB
- Default transmit value

SPI009: For the type `Spi_ConfigType`, the definition for each Job shall contain:

- Assigned SPI HW Unit
- Assigned Chip Select pin (it is possible to assign no pin)
- Chip select functionality on/off
- Chip select pin polarity high or low
- Baud rate
- Timing between clock and chip select
- Shift clock idle low or idle high
- Data shift with leading or trailing edge

- Priority (4 levels are available from 0, the lower to 3, the higher)
- Job finish end notification function
- MCU dependent properties for the Job (only if needed)
- Fixed link of Channels (at least one)

SPI064: For the type `Spi_ConfigType`, the definition for each Sequence shall contain:

- Collection of Jobs (at least one)
- Interruptible or not interruptible after each Job
- Sequence finish end notification function

SPI010: For the type `Spi_ConfigType`, the configuration will map the Jobs to the different SPI hardware units and the devices.

8.2.2 Spi_StatusType

Name:	Spi_StatusType	
Type:	Enumeration	
Range:	SPI_UNINIT	The SPI Handler/Driver is not initialized or not usable.
	SPI_IDLE	The SPI Handler/Driver is not currently transmitting any Job.
	SPI_BUSY	The SPI Handler/Driver is performing a SPI Job (transmit).
Description:	This type defines a range of specific status for SPI Handler/Driver.	

SPI061: The type `Spi_StatusType` defines a range of specific status for SPI Handler/Driver. It informs about the SPI Handler/Driver status and can be obtained calling the API service `Spi_GetStatus` or the configurable `Spi_GetHWUnitStatus`.

SPI011: After reset, the type `Spi_StatusType` shall have the default value `SPI_UNINIT` with the numeric value 0.

8.2.3 Spi_JobResultType

Name:	Spi_JobResultType	
Type:	Enumeration	
Range:	SPI_JOB_OK	The last transmission of the Job has been finished successfully.
	SPI_JOB_PENDING	The SPI Handler/Driver is performing a SPI Job. The meaning of this status is equal to <code>SPI_BUSY</code> .
	SPI_JOB_FAILED	The last transmission of the Job has failed.
Description:	This type defines a range of specific Jobs status for SPI Handler/Driver.	

SPI062: The type `Spi_JobResultType` defines a range of specific Jobs status for SPI Handler/Driver. It informs about a SPI Handler/Driver Job status and can be obtained calling the API service `Spi_GetJobResult` with the Job ID.

SPI012: After reset, the type `Spi_JobResultType` shall have the default value `SPI_JOB_OK` with the numeric value 0.

8.2.4 Spi_SeqResultType

Name:	Spi_SeqResultType	
Type:	Enumeration	
Range:	SPI_SEQ_OK	The last transmission of the Sequence has been finished successfully.
	SPI_SEQ_PENDING	The SPI Handler/Driver is performing a SPI Sequence. The meaning of this status is equal to SPI_BUSY.
	SPI_SEQ_FAILED	The last transmission of the Sequence has failed.
	SPI_SEQ_CANCELLED	The last transmission of the Sequence has been cancelled by user.
Description:	This type defines a range of specific Sequences status for SPI Handler/Driver.	

SPI019: The type `Spi_SeqResultType` defines a range of specific Sequences status for SPI Handler/Driver. It informs about a SPI Handler/Driver Sequence status and can be obtained calling the API service `Spi_GetSequenceResult` with the Sequence ID.

SPI017: After reset, the type `Spi_SeqResultType` shall have the default value `SPI_SEQ_OK` with the numeric value 0.

8.2.5 Spi_DataType

Name:	Spi_DataType	
Type:	uint8, uint16, uint32	
Range:	8..32 bit	This is implementation specific but not all values may be valid within the type. This type shall be chosen in order to have the most efficient implementation on a specific microcontroller platform.
Description:	Type of application data buffer elements.	

SPI164: The type `Spi_DataType` refers to application data buffer elements.

8.2.6 Spi_NumberOfDataType

Name:	Spi_NumberOfDataType	
Type:	uint16	
Description:	Type for defining the number of data elements of the type <code>Spi_DataType</code> to send and / or receive by Channel	

SPI165: The type `Spi_NumberOfDataType` is used for defining the number of data elements of the type `Spi_DataType` to send and / or receive by Channel.

8.2.7 Spi_ChannelType

Name:	Spi_ChannelType	
--------------	-----------------	--

Type:	uint8
Description:	Specifies the identification (ID) for a Channel.

SPI166: The type `Spi_ChannelType` is used for specifying the identification (ID) for a Channel.

8.2.8 Spi_JobType

Name:	<code>Spi_JobType</code>
Type:	uint16
Description:	Specifies the identification (ID) for a Job.

SPI167: The type `Spi_JobType` is used for specifying the identification (ID) for a Job.

8.2.9 Spi_SequenceType

Name:	<code>Spi_SequenceType</code>
Type:	uint8
Description:	Specifies the identification (ID) for a sequence of jobs.

SPI168: The type `Spi_SequenceType` is used for specifying the identification (ID) for a sequence of jobs.

8.2.10 Spi_HWUnitType

Name:	<code>Spi_HWUnitType</code>
Type:	uint8
Description:	Specifies the identification (ID) for a SPI Hardware microcontroller peripheral (unit).

SPI169: The type `Spi_HWUnitType` is used for specifying the identification (ID) for a SPI Hardware microcontroller peripheral (unit).

8.2.11 Spi_AsyncModeType

Name:	<code>Spi_AsyncModeType</code>	
Type:	Enumeration	
Range:	<code>SPI_POLLING_MODE</code>	The asynchronous mechanism is ensured by polling, so interrupts related to SPI busses handled asynchronously are disabled.
	<code>SPI_INTERRUPT_MODE</code>	The asynchronous mechanism is ensured by interrupt, so interrupts related to SPI busses handled asynchronously are enabled.
Description:	Specifies the asynchronous mechanism mode for SPI busses handled asynchronously in LEVEL 2.	

SPI170: The type `Spi_AsyncModeType` is used for specifying the asynchronous mechanism mode for SPI busses handled asynchronously in LEVEL 2.

SPI150: The type `Spi_AsyncModeType` is made available or not depending on the pre-compile time parameter: `SpiLevelDelivered`. This is only relevant for LEVEL 2.

8.3 Function definitions

8.3.1 Spi_Init

SPI175:

Service name:	Spi_Init	
Syntax:	<pre>void Spi_Init(const Spi_ConfigType* ConfigPtr)</pre>	
Service ID[hex]:	0x00	
Sync/Async:	Synchronous	
Reentrancy:	Non Reentrant	
Parameters (in):	ConfigPtr	Pointer to configuration set
Parameters (in-out):	None	
Parameters (out):	None	
Return value:	None	
Description:	Service for SPI initialization.	

SPI013: The function `Spi_Init` shall initialize all SPI relevant registers with the values of the structure referenced by the parameter `ConfigPtr`.

SPI082: The function `Spi_Init` shall define default values for required parameters of the structure referenced by the `ConfigPtr`. For example: all buffer pointers shall be initialized as a null value pointer.

SPI015: After the module initialization using the function `Spi_Init`, the SPI Handler/Driver shall set its state to `SPI_IDLE`, the Sequences result to `SPI_SEQ_OK` and the jobs result to `SPI_JOB_OK`.

SPI151: For LEVEL 2 (see chapter 7.2.5 and [SPI103](#)), the function `Spi_Init` shall set the SPI Handler/Driver asynchronous mechanism mode to `SPI_POLLING_MODE` by default. Interrupts related to SPI busses shall be disabled.

A re-initialization of a SPI Handler/Driver by executing the `Spi_Init()` function requires a de-initialization before by executing a `Spi_DeInit()`.

Parameters of the function `Spi_Init` shall be checked as it is explained in section [API parameter checking](#)

8.3.2 Spi_DeInit

SPI176:

Service name:	Spi_DeInit	
Syntax:	Std_ReturnType Spi_DeInit())	
Service ID[hex]:	0x01	
Sync/Async:	Synchronous	
Reentrancy:	Non Reentrant	
Parameters (in):	None	
Parameters (in-out):	None	
Parameters (out):	None	
Return value:	Std_ReturnType	E_OK: de-initialisation command has been accepted E_NOT_OK: de-initialisation command has not been accepted
Description:	Service for SPI de-initialization.	

SPI021: The function `Spi_DeInit` shall de-initialization SPI Handler/Driver. In case of a `SPI_BUSY` state, the SPI Handler/Driver shall reject this command. Otherwise, the De-Initialization function shall put all already initialized microcontroller SPI peripherals into the same state such as Power On Reset.

SPI022: After the module de-initialization using the function `Spi_DeInit`, the SPI Handler/Driver shall set its state to `SPI_UNINIT`.

The SPI Handler/Driver shall have been initialized before the function `Spi_DeInit` is called, otherwise see [SPI046].

8.3.3 Spi_WriteIB

SPI177:

Service name:	Spi_WriteIB	
Syntax:	Std_ReturnType Spi_WriteIB(Spi_ChannelType Channel, const Spi_DataType* DataBufferPtr)	
Service ID[hex]:	0x02	
Sync/Async:	Synchronous	
Reentrancy:	Reentrant	
Parameters (in):	Channel	Channel ID.
	DataBufferPtr	Pointer to source data buffer. If this pointer is null, it is assumed that the data to be transmitted is not relevant and the default transmit value of this channel will be used instead.
Parameters (in-out):	None	
Parameters (out):	None	
Return value:	Std_ReturnType	E_OK: write command has been accepted E_NOT_OK: write command has not been accepted
Description:	Service for writing one or more data to an IB SPI Handler/Driver Channel specified	

	by parameter.
--	---------------

SPI018: The function `Spi_WriteIB` shall write one or more data to an IB SPI Handler/Driver Channel specified by the respective parameter.

SPI024: The function `Spi_WriteIB` shall take over the given parameters, and save the pointed data to the internal buffer defined with the function `Spi_Init`.

SPI023: If the given parameter “DataBufferPtr” is null, the function `Spi_WriteIB` shall assume that the data to be transmitted is not relevant and the default transmit value of the given channel shall be used instead.

SPI137: The function `Spi_WriteIB` shall be pre-compile time configurable by the parameter `SpiChannelBuffersAllowed`. This function is only relevant for Channels with IB.

Parameters of the function `Spi_WriteIB` shall be checked as it is explained in section [API parameter checking](#).

The SPI Handler/Driver shall have been initialized before the function `Spi_WriteIB` is called, otherwise see [\[SPI046\]](#).

8.3.4 Spi_AsyncTransmit

SPI178:

Service name:	Spi_AsyncTransmit	
Syntax:	Std_ReturnType Spi_AsyncTransmit(Spi_SequenceType Sequence)	
Service ID[hex]:	0x03	
Sync/Async:	Asynchronous	
Reentrancy:	Reentrant	
Parameters (in):	Sequence	Sequence ID.
Parameters (in-out):	None	
Parameters (out):	None	
Return value:	Std_ReturnType	E_OK: Transmission command has been accepted E_NOT_OK: Transmission command has not been accepted
Description:	Service to transmit data on the SPI bus.	

SPI020: The function `Spi_AsyncTransmit` shall take over the given parameter, initiate a transmission, set the SPI Handler/Driver status to `SPI_BUSY`, set the sequence result to `SPI_SEQ_PENDING` and return.

SPI157: When the function `Spi_AsyncTransmit` is called, the SPI Handler/Driver shall handle the Job results when the transmission of Jobs is started (result set to `SPI_JOB_PENDING`) and/or ended (set either to `SPI_JOB_OK` or `SPI_JOB_FAILED`).

SPI081: When the function `Spi_AsyncTransmit` is called and the requested Sequence is already in state `SPI_SEQ_PENDING`, the SPI Handler/Driver shall not take in account this new request and this function shall return with value `E_NOT_OK`. In this case and according to [\[SPI100\]](#), the SPI Handler/Driver shall report the `SPI_E_SEQ_PENDING` error.

SPI086: When the function `Spi_AsyncTransmit` is called and the requested Sequence shares Jobs with another sequence that is in the state `SPI_SEQ_PENDING`, the SPI Handler/Driver shall not take into account this new request and this function shall return the value `E_NOT_OK`. In this case and according to [\[SPI100\]](#), the SPI Handler/Driver shall report the `SPI_E_SEQ_PENDING` error.

SPI035: When the function `Spi_AsyncTransmit` is used with EB and the source data pointer has been provided as NULL using the `Spi_SetupEB` method, the default transmit data configured for each channel will be transmitted. (See also [\[SPI028\]](#))

SPI036: When the function `Spi_AsyncTransmit` is used with EB and the destination data pointer has been provided as NULL using the `Spi_SetupEB` method, the SPI Handler/Driver shall ignore receiving data (See also [\[SPI030\]](#))

SPI055: When the function `Spi_AsyncTransmit` is used for a Sequence with linked Jobs, the function shall transmit from the first Job up to the last Job in the sequence.

SPI057: At the end of a sequence transmission initiated by the function `Spi_AsyncTransmit` and if configured, the SPI Handler/Driver shall invoke the sequence notification call-back function after the last Job end notification if this one is also configured.

SPI133: The function `Spi_AsyncTransmit` is pre-compile time selectable by the configuration parameter `SpiLevelDelivered`. This function is only relevant for LEVEL 1 and LEVEL 2.

SPI173: The SPI Handler/Driver's environment shall call the function `Spi_AsyncTransmit` after a function call of `Spi_SetupEB` for EB Channels or a function call of `Spi_WriteIB` for IB Channels but before the function call `Spi_ReadIB`.

Parameters of the function `Spi_AsyncTransmit` shall be checked as explained in section [API parameter checking](#)

The SPI Handler/Driver shall have been initialized before the function `Spi_AsyncTransmit` is called otherwise see [\[SPI046\]](#).

8.3.5 Spi_ReadIB

SPI179:

Service name:	Spi_ReadIB	
Syntax:	<pre>Std_ReturnType Spi_ReadIB(Spi_ChannelType Channel, Spi_DataType* DataBufferPointer)</pre>	
Service ID[hex]:	0x04	
Sync/Async:	Synchronous	
Reentrancy:	Reentrant	
Parameters (in):	Channel	Channel ID.
Parameters (in-out):	None	
Parameters (out):	DataBufferPointer	Pointer to destination data buffer in RAM
Return value:	Std_ReturnType	E_OK: read command has been accepted E_NOT_OK: read command has not been accepted
Description:	Service for reading synchronously one or more data from an IB SPI Handler/Driver Channel specified by parameter.	

SPI016: The function `Spi_ReadIB` shall read synchronously one or more data from an IB SPI Handler/Driver Channel specified by the respective parameter.

SPI027: The SPI Handler/Driver's environment shall call the function `Spi_ReadIB` after a Transmit method call to have relevant data within IB Channel.

SPI138: The function `Spi_ReadIB` is pre-compile time configurable by the parameter `SpiChannelBuffersAllowed`. This function is only relevant for Channels with IB.

Parameters of the function `Spi_ReadIB` shall be checked as it is explained in section [API parameter checking](#).

The SPI Handler/Driver shall have been initialized before the function `Spi_ReadIB` is called otherwise see [\[SPI046\]](#).

8.3.6 Spi_SetupEB

SPI180:

Service name:	Spi_SetupEB	
Syntax:	<pre>Std_ReturnType Spi_SetupEB(Spi_ChannelType Channel, const Spi_DataType* SrcDataBufferPtr, Spi_DataType* DesDataBufferPtr, Spi_NumberOfDataType Length)</pre>	
Service ID[hex]:	0x05	
Sync/Async:	Synchronous	
Reentrancy:	Reentrant	
Parameters (in):	Channel	Channel ID.
	SrcDataBufferPtr	Pointer to source data buffer.
	DesDataBufferPtr	Pointer to destination data buffer in RAM.

	Length	Length of the data to be transmitted from SrcdataBufferPtr and/or received from DesDataBufferPtr Min.: 1 Max.: Max of data specified at configuration for this channel
Parameters (in-out):	None	
Parameters (out):	None	
Return value:	Std_ReturnType	E_OK: Setup command has been accepted E_NOT_OK: Setup command has not been accepted
Description:	Service to setup the buffers and the length of data for the EB SPI Handler/Driver Channel specified.	

SPI058: The function `Spi_SetupEB` shall set up the buffers and the length of data for the specific EB SPI Handler/Driver Channel.

SPI067: The function `Spi_SetupEB` shall update the buffer pointers and length attributes of the specified Channel with the provided values.

As these attributes are persistent, they will be used for all succeeding calls to a Transmit method (for the specified Channel).

SPI028: When the SPI Handler/Driver's environment is calling the function `Spi_SetupEB` with the parameter `SrcDataBufferPtr` being a Null pointer, the function shall transmit the default transmit value configured for the channel after a Transmit method is requested. (See also [SPI035])

SPI030: When the function `Spi_SetupEB` is called with the parameter `DesDataBufferPtr` being a Null pointer, the SPI Handler/Driver shall ignore the received data after a Transmit method is requested. (See also [SPI036])

SPI037: The SPI Handler/Driver's environment shall call the `Spi_SetupEB` function once for each Channel with EB declared before the SPI Handler/Driver's environment calls a Transmit method on them.

SPI139: The function `Spi_SetupEB` is pre-compile time configurable by the parameter `SpiChannelBuffersAllowed`. This function is only relevant for Channels with EB.

Parameters of the function `Spi_SetupEB` shall be checked as it is explained in section [API parameter checking](#).

The SPI Handler/Driver shall have been initialized before the function `Spi_SetupEB` is called otherwise see [SPI046].

8.3.7 Spi_GetStatus

SPI181:

Service name:	Spi_GetStatus	
Syntax:	Spi_StatusType Spi_GetStatus()	
Service ID[hex]:	0x06	
Sync/Async:	Synchronous	
Reentrancy:	Reentrant	
Parameters (in):	None	
Parameters (in-out):	None	
Parameters (out):	None	
Return value:	Spi_StatusType	Spi_StatusType
Description:	Service returns the SPI Handler/Driver software module status.	

SPI025: The function `Spi_GetStatus` shall return the SPI Handler/Driver software module status.

8.3.8 Spi_GetJobResult

SPI182:

Service name:	Spi_GetJobResult	
Syntax:	Spi_JobResultType Spi_GetJobResult(Spi_JobType Job)	
Service ID[hex]:	0x07	
Sync/Async:	Synchronous	
Reentrancy:	Reentrant	
Parameters (in):	Job	Job ID. An invalid job ID will return an undefined result.
Parameters (in-out):	None	
Parameters (out):	None	
Return value:	Spi_JobResultType	Spi_JobResultType
Description:	This service returns the last transmission result of the specified Job.	

SPI026: The function `Spi_GetJobResult` shall return the last transmission result of the specified Job.

SPI038: The SPI Handler/Driver's environment shall call the function `Spi_GetJobResult` to inquire whether the Job transmission has succeeded (`SPI_JOB_OK`) or failed (`SPI_JOB_FAILED`).

NOTE: Every new transmit job that has been accepted by the SPI Handler/Driver overwrites the previous job result with `SPI_JOB_PENDING`.

Parameters of the function `Spi_GetJobResult` shall be checked as it is explained in section [API parameter checking](#).

If SPI Handler/Driver has not been initialized before the function `Spi_GetJobResult` is called, the return value is undefined.

8.3.9 Spi_GetSequenceResult

SPI183:

Service name:	Spi_GetSequenceResult	
Syntax:	Spi_SeqResultType Spi_GetSequenceResult(Spi_SequenceType Sequence)	
Service ID[hex]:	0x08	
Sync/Async:	Synchronous	
Reentrancy:	Reentrant	
Parameters (in):	Sequence	Sequence ID. An invalid sequence ID will return an undefined result.
Parameters (in-out):	None	
Parameters (out):	None	
Return value:	Spi_SeqResultType	Spi_SeqResultType
Description:	This service returns the last transmission result of the specified Sequence.	

SPI039: The function `Spi_GetSequenceResult` shall return the last transmission result of the specified Sequence.

SPI042: The SPI Handler/Driver's environment shall call the function `Spi_GetSequenceResult` to inquire whether the full Sequence transmission has succeeded (`SPI_SEQ_OK`) or failed (`SPI_SEQ_FAILED`).

Note:

- Every new transmit sequence that has been accepted by the SPI Handler/Driver overwrites the previous sequence result with `SPI_SEQ_PENDING`.
- If the SPI Handler/Driver has not been initialized before the function `Spi_GetSequenceResult` is called, the return value is undefined.

Parameters of the function `Spi_GetSequenceResult` shall be checked as it is explained in section [API parameter checking](#).

8.3.10 Spi_GetVersionInfo

SPI184:

Service name:	Spi_GetVersionInfo
----------------------	--------------------

Syntax:	void Spi_GetVersionInfo(Std_VersionInfoType* versioninfo)
Service ID[hex]:	0x09
Sync/Async:	Synchronous
Reentrancy:	Non Reentrant
Parameters (in):	None
Parameters (in-out):	None
Parameters (out):	versioninfo Pointer to where to store the version information of this module.
Return value:	None
Description:	This service returns the version information of this module.

SPI101: The function `Spi_GetVersionInfo` shall return the version information of the module. The version information includes:

- Module Id
- Vendor Id
- Vendor specific version numbers (BSW00407).

SPI196: If source code for caller and callee of `Spi_GetVersionInfo` is available, the SPI Handler/Driver should realize `Spi_GetVersionInfo` as a macro, defined in the module's header file.

SPI102: The function `Spi_GetVersionInfo` is pre-compile time configurable On/Off by the configuration parameter `SpiVersionInfoApi`.

8.3.11 Spi_SyncTransmit

SPI185:

Service name:	Spi_SyncTransmit	
Syntax:	Std_ReturnType Spi_SyncTransmit(Spi_SequenceType Sequence)	
Service ID[hex]:	0x0a	
Sync/Async:	Synchronous	
Reentrancy:	Reentrant	
Parameters (in):	Sequence	Sequence ID.
Parameters (in-out):	None	
Parameters (out):	None	
Return value:	Std_ReturnType	E_OK: Transmission command has been accepted E_NOT_OK: Transmission command has not been accepted
Description:	Service to transmit data on the SPI bus	

SPI134: The function `Spi_SyncTransmit` shall take over the given parameter, set the SPI Handler/Driver status to `SPI_BUSY`, set the sequence result to `SPI_SEQ_PENDING`, set the first job result to `SPI_JOB_PENDING` and perform the transmission.

SPI135: When the function `Spi_SyncTransmit` is called while a Sequence is on transmission, the SPI Handler/Driver shall not take into account this new transmission request and the function shall return the value `E_NOT_OK` (see [SPI114]). In this case and according to [SPI100], the SPI Handler/Driver shall report the `SPI_E_SEQ_IN_PROCESS` error.

SPI136: The function `Spi_SyncTransmit` is pre-compile time selectable by the configuration parameter `SpiLevelDelivered`. This function is only relevant for LEVEL 0 and LEVEL 2.

Parameters of the function `Spi_SyncTransmit` shall be checked as it is explained in section [API parameter checking](#)

8.3.12 Spi_GetHWUnitStatus

SPI186:

Service name:	Spi_GetHWUnitStatus	
Syntax:	Spi_StatusType Spi_GetHWUnitStatus(Spi_HWUnitType HWUnit)	
Service ID[hex]:	0x0b	
Sync/Async:	Synchronous	
Reentrancy:	Reentrant	
Parameters (in):	HWUnit	SPI Hardware microcontroller peripheral (unit) ID.
Parameters (in-out):	None	
Parameters (out):	None	
Return value:	Spi_StatusType	Spi_StatusType
Description:	This service returns the status of the specified SPI Hardware microcontroller peripheral.	

SPI141: The function `Spi_GetHWUnitStatus` shall return the status of the specified SPI Hardware microcontroller peripheral. The SPI Handler/Driver's environment shall call this function to inquire whether the specified SPI Hardware microcontroller peripheral is `SPI_IDLE` or `SPI_BUSY`.

SPI142: The function `Spi_GetHWUnitStatus` is pre-compile time configurable On / Off by the configuration parameter `SpiHwStatusApi`.

Parameters of the function `Spi_GetHWUnitStatus` shall be checked as it is explained in section [API parameter checking](#).

If SPI Handler/Driver has not been initialized before the function `Spi_GetHWUnitStatus` is called, the return value is undefined.

8.3.13 Spi_Cancel

SPI187:

Service name:	Spi_Cancel	
Syntax:	void Spi_Cancel(Spi_SequenceType Sequence)	
Service ID[hex]:	0x0c	
Sync/Async:	Asynchronous	
Reentrancy:	Reentrant	
Parameters (in):	Sequence	Sequence ID.
Parameters (in-out):	None	
Parameters (out):	None	
Return value:	None	
Description:	Service cancels the specified on-going sequence transmission.	

SPI144: The function `Spi_Cancel` shall cancel the specified on-going sequence transmission without cancelling any Job transmission and set the sequence result to `SPI_SEQ_CANCELLED`.

With other words, the `Spi_Cancel` function stops a Sequence transmission after a (possible) on transmission Job ended and before a (potential) next Job transmission starts.

SPI145: When the sequence is cancelled by the function `Spi_Cancel` and if configured, the SPI Handler/Driver shall call the sequence notification call-back function instead of starting a potential next job belonging to it.

SPI146: The function `Spi_Cancel` is pre-compile time configurable On / Off by the configuration parameter `SpiCancelApi`.

The SPI Handler/Driver is not responsible on external devices damages or undefined state due to cancelling a sequence transmission. It is up to the SPI Handler/Driver's environment to be aware to what it is doing!

8.3.14 Spi_SetAsyncMode

SPI188:

Service name:	Spi_SetAsyncMode	
Syntax:	Std_ReturnType Spi_SetAsyncMode(Spi_AsyncModeType Mode)	
Service ID[hex]:	0x0d	
Sync/Async:	Synchronous	
Reentrancy:	Non Reentrant	
Parameters (in):	Mode	New mode required.
Parameters (in-out):	None	
Parameters (out):	None	
Return value:	Std_ReturnType	E_OK: Setting command has been done E_NOT_OK: setting command has not been accepted

Description:	Service to set the asynchronous mechanism mode for SPI busses handled asynchronously.
---------------------	---

SPI152: The function `Spi_SetAsyncMode` according to the given parameter shall set the asynchronous mechanism mode for SPI channels configured to behave asynchronously and the synchronous mechanism mode for the SPI channels configured to behave synchronously.

SPI171: When the function `Spi_SetAsyncMode` is called in asynchronous mode while the SPI Handler/Driver status is not `SPI_IDLE`, the SPI Handler/Driver shall not take into account the function call, the mode is kept as it is and the function returns the value `E_NOT_OK`.

SPI172: When the function `Spi_SetAsyncMode` is called in synchronous mode, the SPI Handler/Driver shall accept the function call even if the SPI Handler/Driver status is `SPI_BUSY`.

SPI154: The function `Spi_SetAsyncMode` is pre-compile time selectable by the configuration parameter `SpiLevelDelivered`. This function is only relevant for LEVEL 2.

8.4 Callback notifications

This chapter lists all functions provided by the SPI module to lower layer modules.

The SPI Handler/Driver module belongs to the lowest layer of AUTOSAR Software Architecture hence this module specification has not identified any callback functions.

8.5 Scheduled functions

This chapter lists all functions provided by the SPI Handler/Driver and called directly by the Basic Software Module Scheduler.

The SPI Handler/Driver module does not require any scheduled function. The specified functions below exemplify how to implement them if they are needed.

8.5.1 Spi_MainFunction_Handling

SPI189:

Service name:	Spi_MainFunction_Handling
Syntax:	void Spi_MainFunction_Handling()
Service ID[hex]:	0x10
Timing:	FIXED_CYCLIC
Description:	--

8.5.2 Spi_MainFunction_Driving

SPI190:

Service name:	Spi_MainFunction_Driving
Syntax:	void Spi_MainFunction_Driving()
Service ID[hex]:	0x11
Timing:	FIXED_CYCLIC
Description:	--

8.6 Expected Interfaces

This chapter lists all functions that the SPI Handler/Driver requires from other modules.

8.6.1 Mandatory Interfaces

The SPI Handler/Driver module does not define any interface which is required to fulfill its core functionality.

8.6.2 Optional Interfaces

This chapter defines all interfaces which are required to fulfill an optional functionality of SPI Handler/Driver module.

SPI191:

<i>API function</i>	<i>Description</i>
Dem_ReportErrorStatus	Reports errors to the DEM.
Det_ReportError	Service to report development errors.

8.6.3 Configurable interfaces

In this chapter all interfaces are listed where the target function could be configured. The target function is usually a call-back function. The name of these interfaces is not fixed because they are configurable.

SPI075: The SPI Handler/Driver shall use the callback routines `Spi_JobEndNotification` and `Spi_SeqEndNotification` to inform other software modules about certain states or state changes. The other modules are required to provide the routines in the expected manner.

he callback notifications `Spi_JobEndNotification` and `Spi_SeqEndNotification` as function pointers defined within the initialization data structure (`Spi_ConfigType`).

The callback notifications `Spi_JobEndNotification` and `Spi_SeqEndNotification` shall have no parameters and no return value.

SPI054: If a callback notification is configured as null pointer, no callback shall be executed.

SPI085: It is allowed to use the following API calls within the SPI callback notifications:

- `Spi_ReadIB`
- `Spi_WriteIB`
- `Spi_SetupEB`
- `Spi_GetJobResult`
- `Spi_GetSequenceResult`
- `Spi_GetHWUnitStatus`
- `Spi_Cancel`

All other SPI Handler/Driver API calls are not allowed.

8.6.3.1 Spi_JobEndNotification

SPI192:

Service name:	(*Spi_JobEndNotification)
Syntax:	void (*Spi_JobEndNotification)()
Sync/Async:	Synchronous
Reentrancy:	Reentrant
Parameters (in):	None
Parameters (in-out):	None
Parameters (out):	None
Return value:	None
Description:	Callback routine provided by the user for each Job to notify the caller that a job has been finished.

SPI071: If the `SpiJobEndNotification` is configured (i.e. not a null pointer), the SPI Handler/Driver shall call the configured callback notification at the end of a Job transmission.

Note: This routine might be called on interrupt level, depending on the calling function.

8.6.3.2 Spi_SeqEndNotification

SPI193:

Service name:	(*Spi_SeqEndNotification)
Syntax:	void (*Spi_SeqEndNotification)()
Sync/Async:	Synchronous
Reentrancy:	Reentrant
Parameters (in):	None
Parameters (in-out):	None
Parameters (out):	None
Return value:	None
Description:	Callback routine provided by the user for each Sequence to notify the caller that a sequence has been finished.

SPI073: If the `SpiSeqEndNotification` is configured (i.e. not a null pointer), the SPI Handler/Driver shall call the configured callback notification at the end of a Sequence transmission.

Note: This routine might be called on interrupt level, depending on the calling function.

9 Sequence diagrams

9.1 Initialization

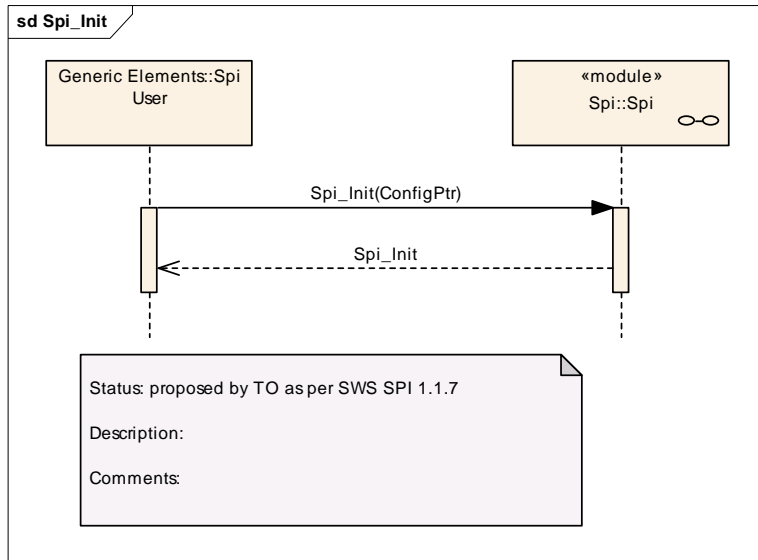

9.2 Modes transitions

The following sequence diagram shows an example of an Init / Delnit calls for a running mode transition.

9.3 Write/AsyncTransmit/Read (IB)

9.3.1 One Channel, one Job then one Sequence

The following sequence diagram shows an example of Spi_WriteIB / Spi_AsyncTransmit / Spi_ReadIB calls for a Sequence transmission with only one Job composed of only one Channel. Write or Read step could be skipped when Job is just reading or writing respectively.

Example: Channel ID 2 belongs to Job ID 1 which belongs to Sequence ID 0

Sequence	Job	Channel
ID0	ID1	ID2

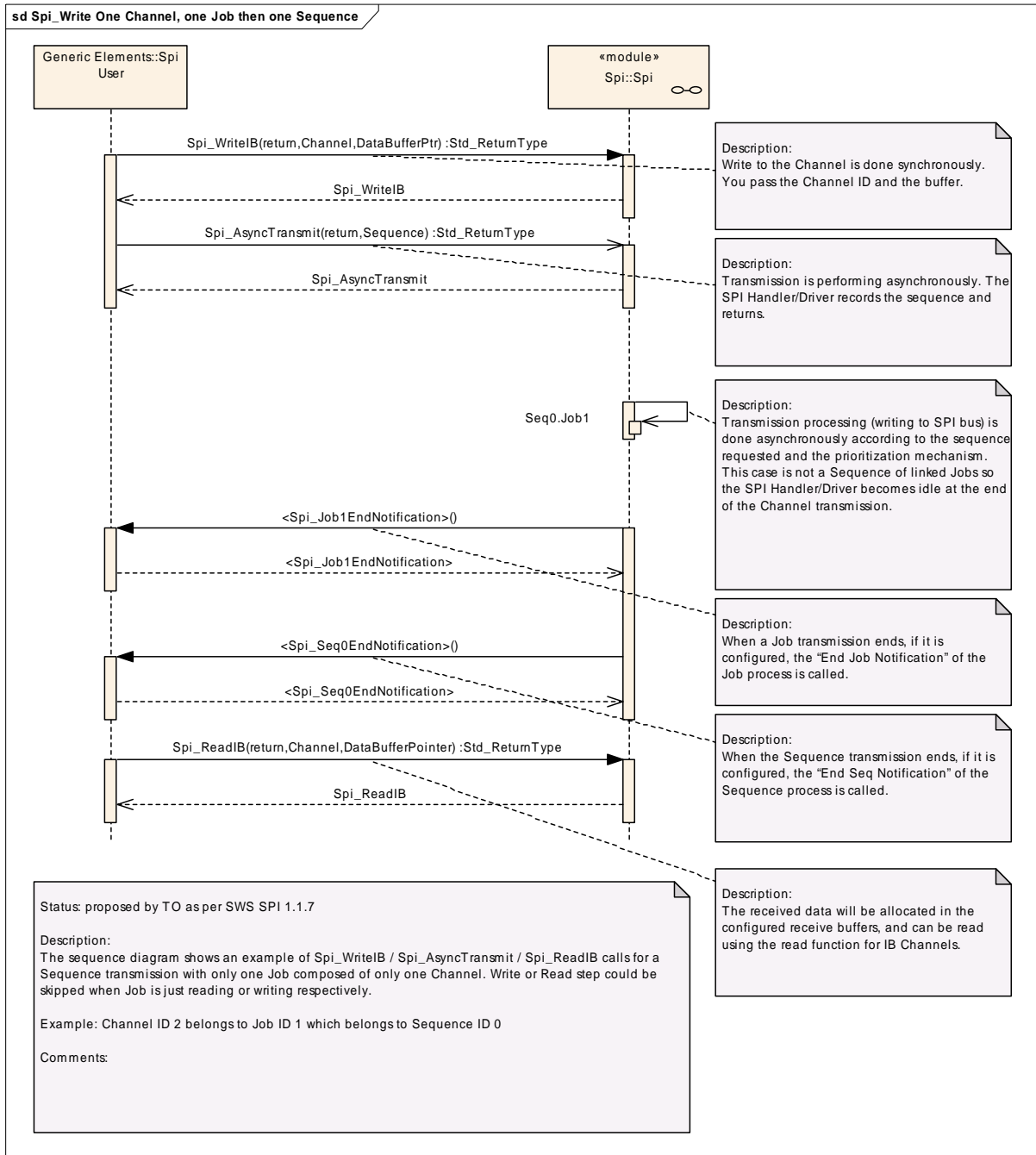

9.3.2 Many Channels, one Job then one Sequence

The following sequence diagram shows an example of Spi_WriteIB / Spi_AsyncTransmit / Spi_ReadIB calls for a Sequence transmission with only one Job composed of many Channels. Write or Read steps could be skipped when Job is just reading or writing respectively.

Example: Channels ID 2 & 3 belong to Job ID 1 which belongs to Sequence ID 0

Sequence	Job	Channel
ID0	ID1	ID2
		ID3

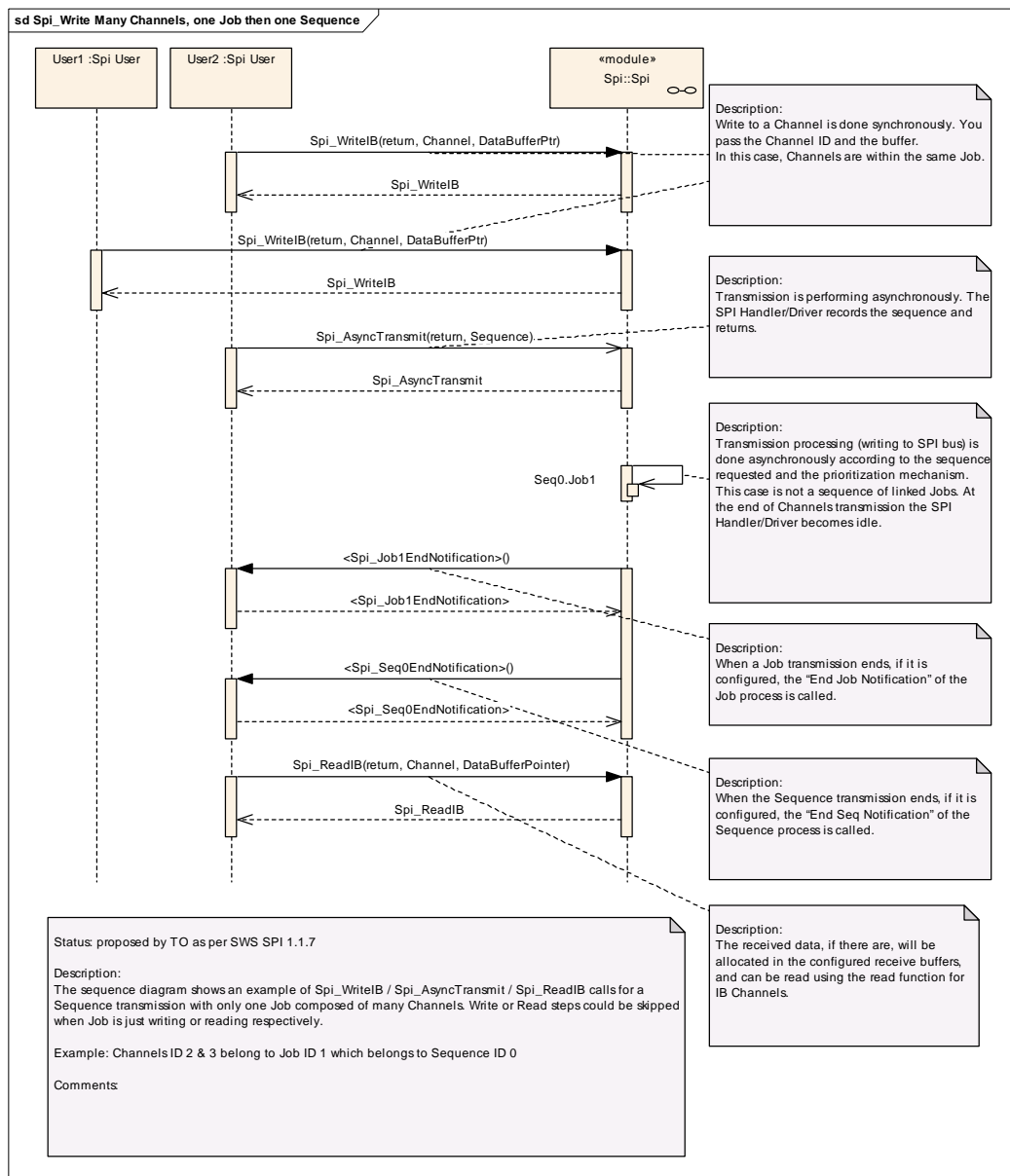

9.3.3 Many Channels, many Jobs and one Sequence

The following sequence diagram shows an example of Spi_WriteIB / Spi_AsyncTransmit / Spi_ReadIB calls for a Sequence transmission of linked Jobs. Write or Read steps could be skipped when Jobs are just reading or writing respectively.

Example: Channels ID 0 to 3 belong to Job ID 1 (higher priority), Channels ID 4 to 10 belong to Job ID 2 (Lower priority) which has not an end notification function. These Jobs belong to the same Sequence ID 0

Sequence	Job		Channel
	Name	Priority	
ID0	ID1	High	ID0...ID3
	ID2	Low	ID4...ID10

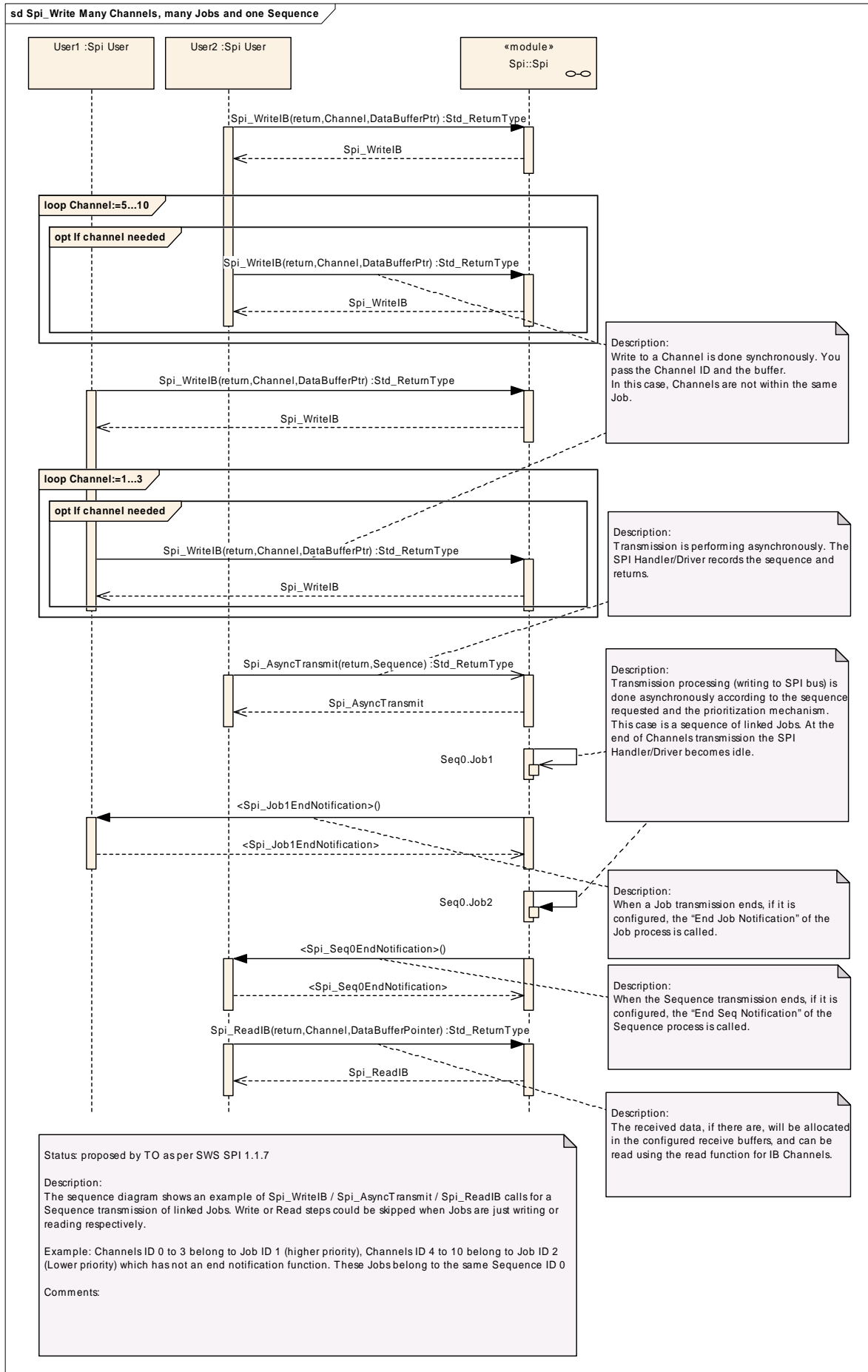

9.3.4 Many Channels, many Jobs and many Sequences

The following sequence diagram shows an example of Spi_WriteIB / Spi_AsyncTransmit / Spi_ReadIB calls for Sequences transmission. Write or Read steps could be skipped when Jobs are just reading or writing respectively.

Example: Channels ID 0 to 3 belong to Job ID 1 (high priority 2), Channels ID 4 to 10 belong to Job ID 2 (Low priority 1) which has not an end notification function. These Jobs belong to the same Sequence ID 0 which is configured as interruptible. Channels ID 11 to 13 belong to Job ID 0 (higher priority 3) which belongs to Sequence ID 1 which is configured as not interruptible.

Sequence		Job		Channel
Name	Interruptible	Name	Priority	
ID0	Yes	ID1	2	ID0...ID3
		ID2	1	ID4...ID10
ID1	No	ID0	3	ID11...ID13

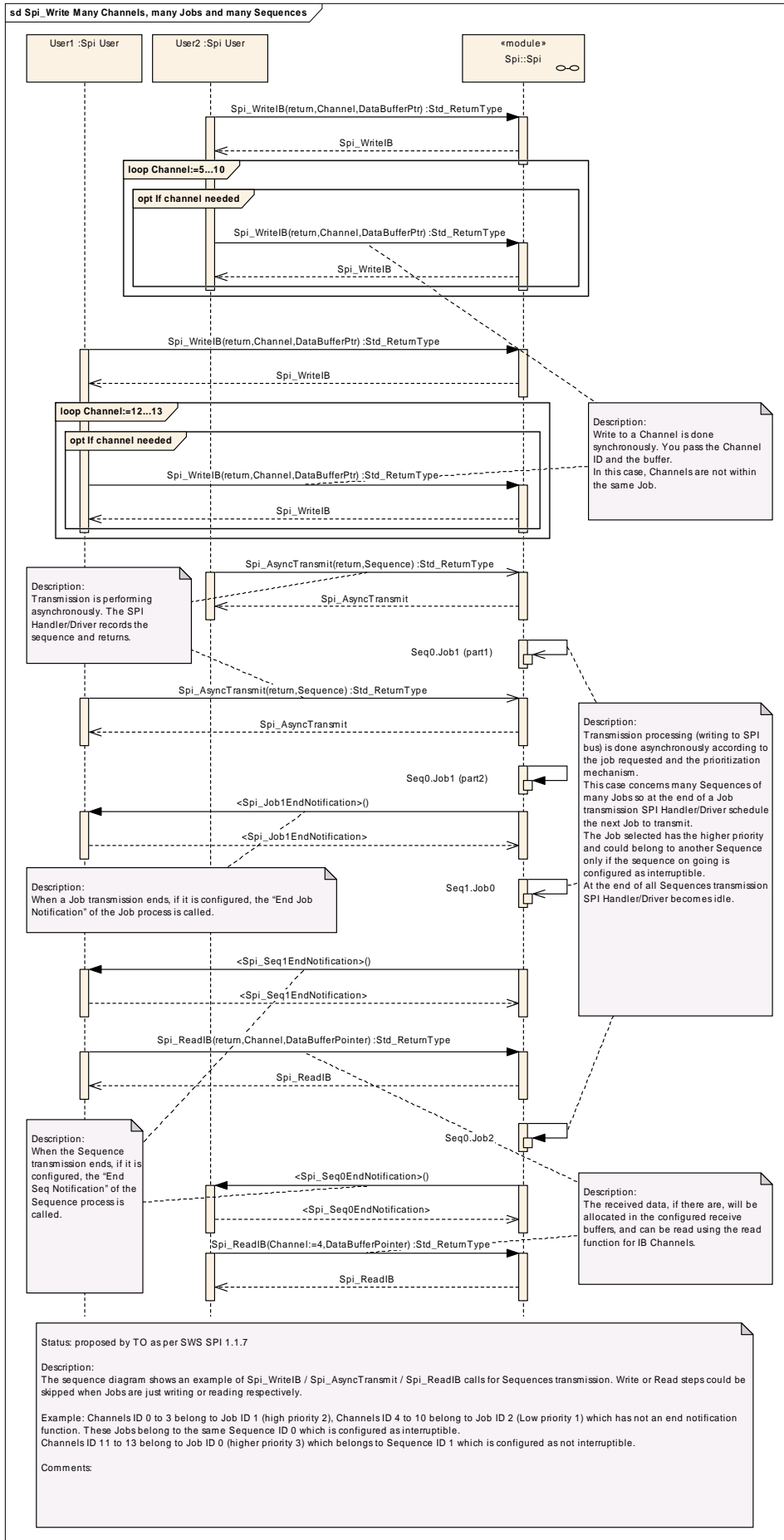

9.4 Setup/AsyncTransmit (EB)

9.4.1 Variable Number of Data / Constant Number of Data

SPI077: To transmit a variable number of data, it is mandatory to call the `Spi_SetupEB` function to store new parameters within SPI Handler/Driver before each `Spi_AsyncTransmit` function call.

SPI078: To transmit a constant number of data, it is only mandatory to call the `Spi_SetupEB` function to store parameters within SPI Handler/Driver before the first `Spi_AsyncTransmit` function call.

9.4.2 One Channel, one Job then one Sequence

The following sequence diagram shows an example of `Spi_SetupEB` / `Spi_AsyncTransmit` calls for a Sequence transmission with only one Job composed of only one Channel. Write or Read accesses are “User Dependant” and could be skipped when Job is just reading or writing respectively.

Example: Channel ID 2 belongs to Job ID 1 which belongs to Sequence ID 0

Sequence	Job	Channel
ID0	ID1	ID2

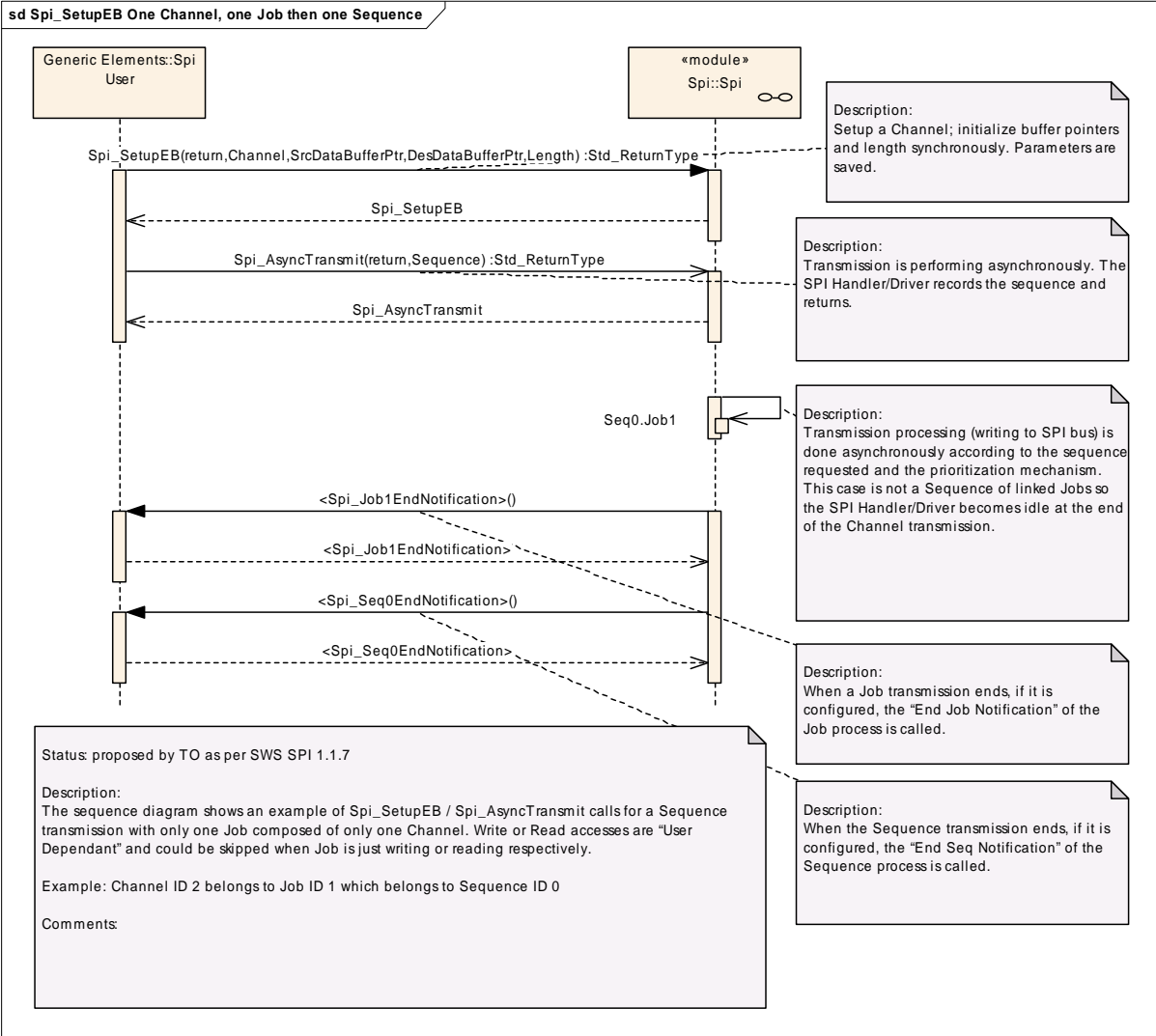

9.4.3 Many Channels, one Job then one Sequence

The following sequence diagram shows an example of `Spi_SetupEB` / `Spi_AsyncTransmit` calls for a Sequence transmission with only one Job composed of many Channels. Write or Read accesses are "User Dependant" and could be skipped when Job is just reading or writing respectively.

Example: Channels ID 2 & 3 belong to Job ID 1 which belongs to Sequence ID 0

Sequence	Job	Channel
ID0	ID1	ID2
		ID3

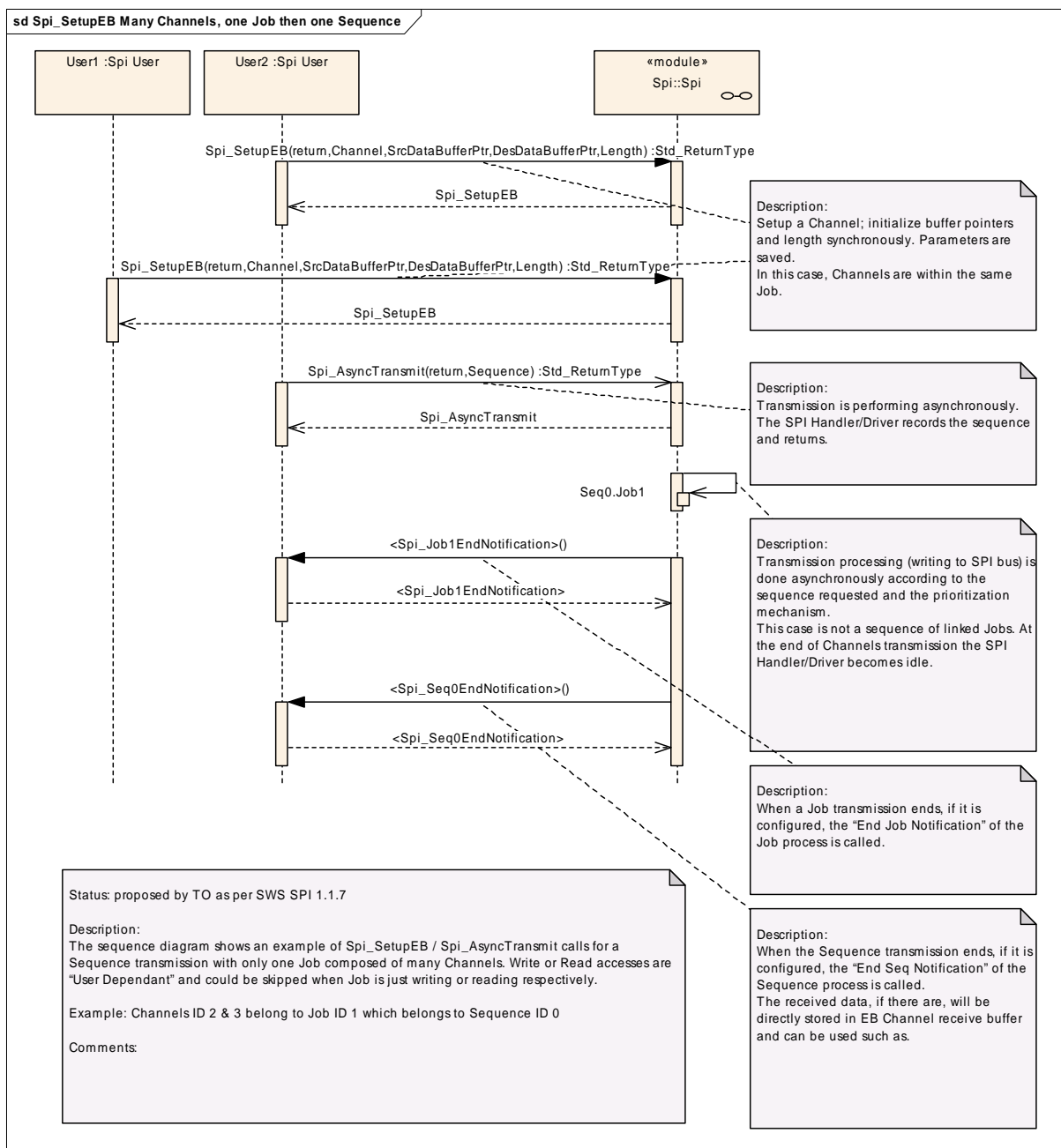

9.4.4 Many Channels, many Jobs and one Sequence

The following sequence diagram shows an example of `Spi_SetupEB` / `Spi_AsyncTransmit` calls for a Sequence transmission of linked Jobs. Write or Read accesses are “User Dependant” and could be skipped when Job is just reading or writing respectively.

Example: Channels ID 0 to 3 belong to Job ID 1 (higher priority), Channels ID 4 to 10 belong to Job ID 2 (Lower priority) which has not an end notification function. These Jobs belong to the same Sequence ID 0

Sequence	Job	Channel
ID0	ID1	ID0...ID3
	ID2	ID4...ID10

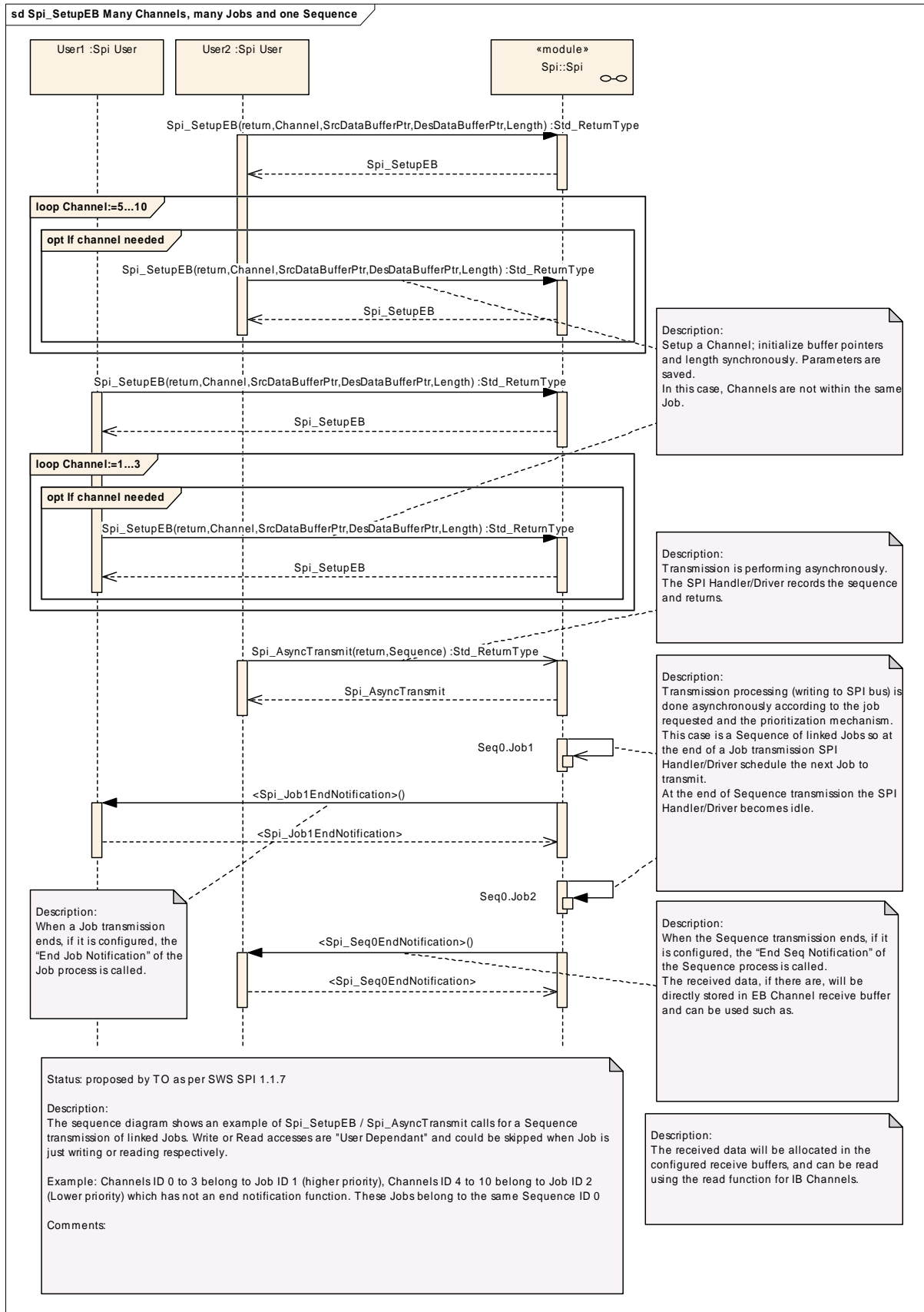

9.4.5 Many Channels, many Jobs and many Sequences

The following sequence diagram shows an example of `Spi_SetupEB` / `Spi_AsyncTransmit` calls for Sequences transmission. Write or Read accesses are “User Dependant” and could be skipped when Job is just reading or writing respectively.

Example: Channels ID 0 to 3 belong to Job ID 1 (high priority 2), Channels ID 4 to 10 belong to Job ID 2 (Low priority 1) which has not an end notification function. These Jobs belong to the same Sequence ID 0 which is configured as interruptible. Channels ID 11 to 13 belong to Job ID 0 (higher priority 3) which belongs to Sequence ID 1 which is configured as not interruptible.

Sequence		Job		Channel
Name	Interruptible	Name	Priority	
ID0	Yes	ID1	2	ID0...ID3
		ID2	1	ID4...ID10
ID1	No	ID0	3	ID11...ID13

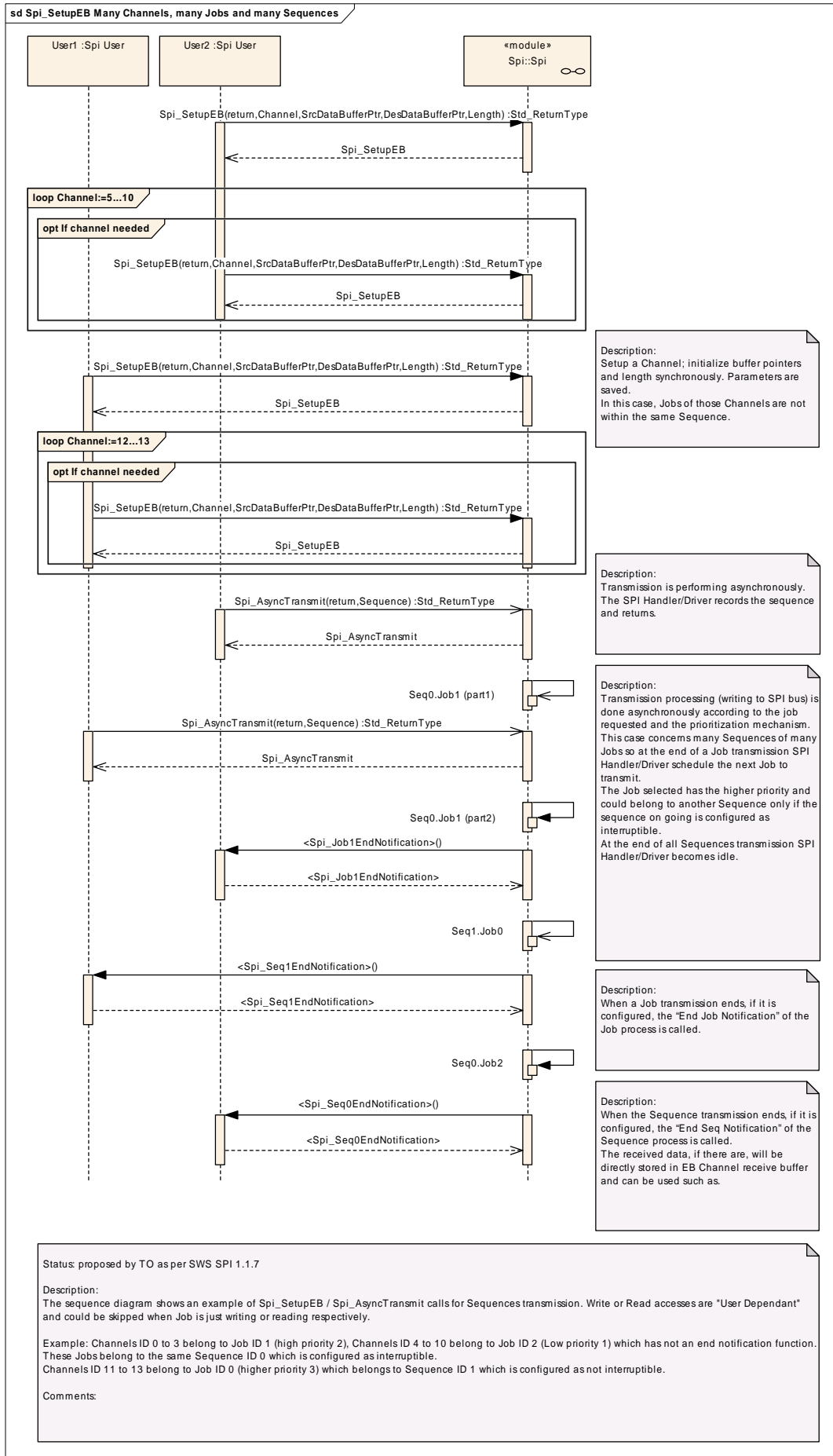

9.5 Mixed Jobs Transmission

All kind of mixed Jobs transmission is possible according to the Channels configuration and the priority requirement inside Sequences.

The user knows which Channels are in use. Then, according to the types of these Channels, the appropriate methods shall be called.

9.6 LEVEL 0 SyncTransmit diagrams

9.6.1 Write/SyncTransmit/Read (IB): Many Channels, many Jobs and one Sequence

The following sequence diagram shows an example of Spi_WriteIB / Spi_SyncTransmit / Spi_ReadIB calls for a Sequence transmission of linked Jobs. Write or Read steps could be skipped when Jobs are just reading or writing respectively.

Example: Channels ID 0 to 3 belong to Job ID 1 (higher priority), Channels ID 4 to 10 belong to Job ID 2 (Lower priority). These Jobs belong to the same Sequence ID 0

Sequence	Job		Channel
	Name	Priority	
ID0	ID1	High	ID0...ID3
	ID2	Low	ID4...ID10

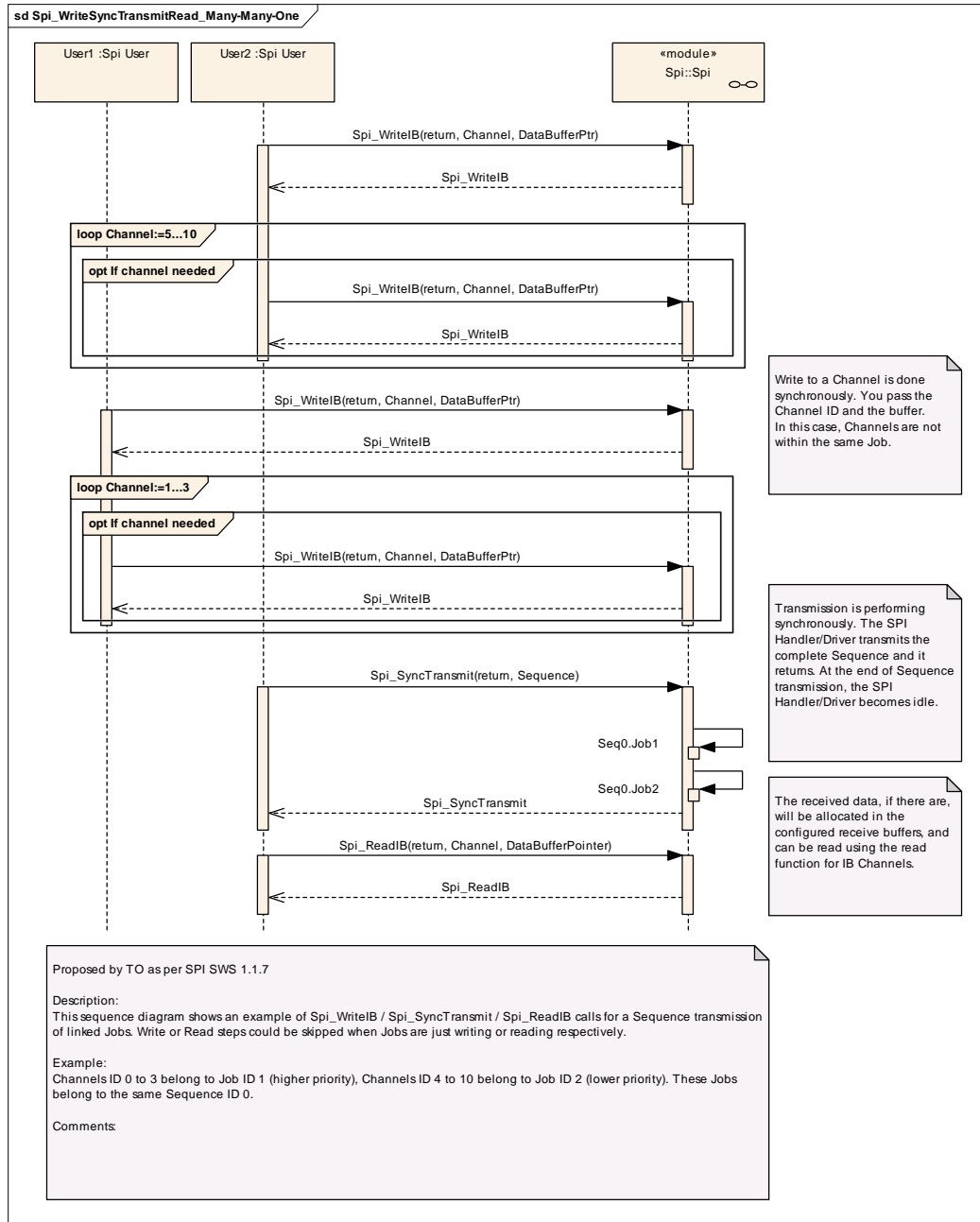

9.6.2 Setup/SyncTransmit (EB): Many Channels, many Jobs and one Sequence

The following sequence diagram shows an example of Spi_SetupEB / Spi_SyncTransmit calls for a Sequence transmission of linked Jobs. Write or Read accesses are “User Dependant” and could be skipped when Job is just reading or writing respectively.

Example: Channels ID 0 to 3 belong to Job ID 1 (higher priority), Channels ID 4 to 10 belong to Job ID 2 (Lower priority). These Jobs belong to the same Sequence ID 0

Sequence	Job	Channel
ID0	ID1	ID0...ID3
	ID2	ID4...ID10

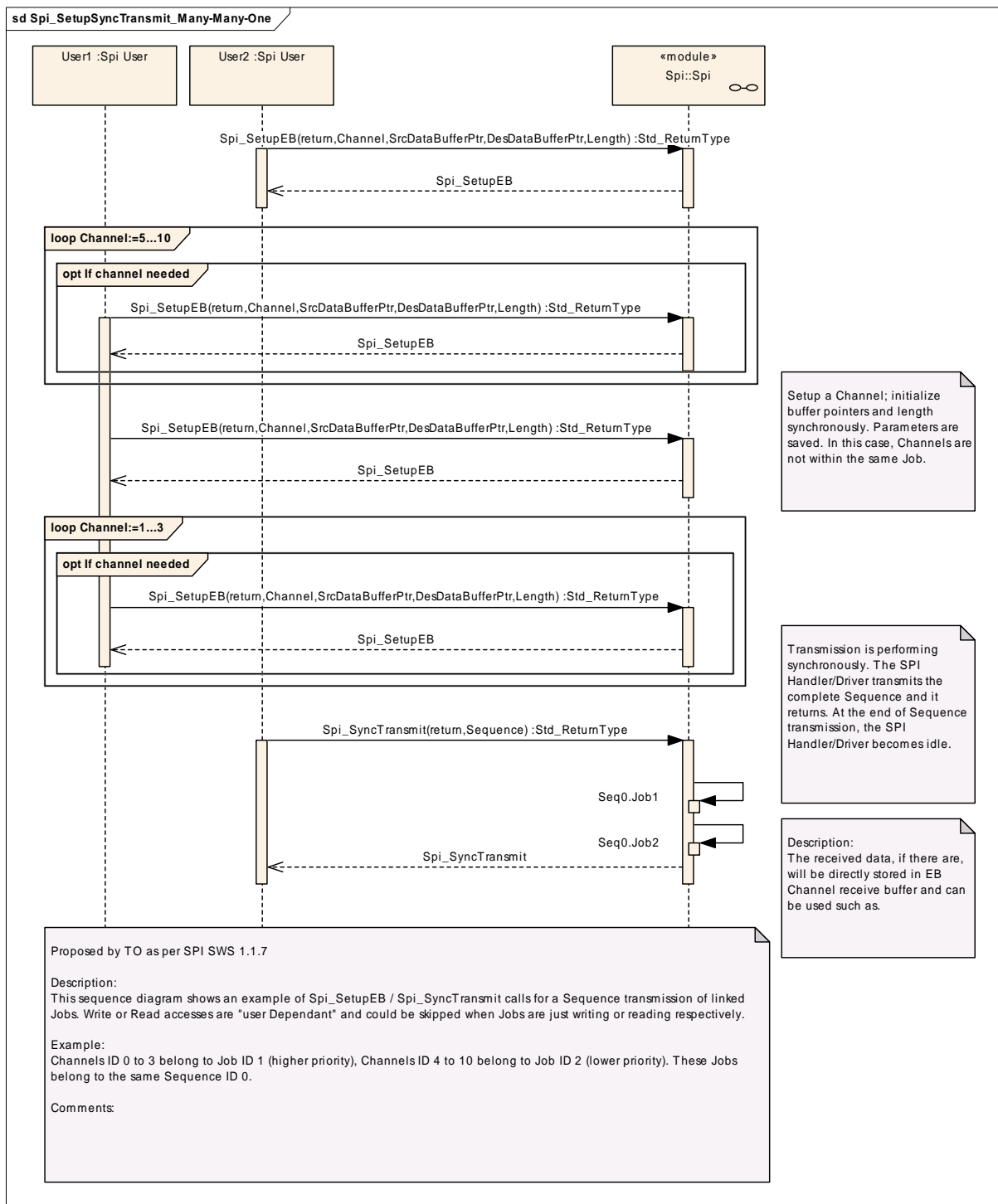

10 Configuration specification

10.1 How to read this chapter

In addition to this section, it is highly recommended to read the documents:

- AUTOSAR Layered Software Architecture [1]
- AUTOSAR ECU Configuration Specification [5]
This document describes the AUTOSAR configuration methodology and the AUTOSAR configuration metamodel in detail.

The following is only a short survey of the topic and it will not replace the ECU Configuration Specification document.

10.1.1 Configuration and configuration parameters

Configuration parameters define the variability of the generic part(s) of an implementation of a module. This means that only generic or configurable module implementation can be adapted to the environment (software/hardware) in use during system and/or ECU configuration.

The configuration of parameters can be achieved at different times during the software process: before compile time, before link time or after build time. In the following, the term “configuration class” (of a parameter) shall be used in order to refer to a specific configuration point in time.

10.1.2 Containers

Containers structure the set of configuration parameters. This means:

- *all* configuration parameters are kept in containers.
- (sub-) containers can reference (sub-) containers. It is possible to assign a multiplicity to these references. The multiplicity then defines the possible number of instances of the contained parameters.

10.1.3 Specification template for configuration parameters

The following tables consist of three sections:

- the general section
- the configuration parameter section
- the section of included/referenced containers

Pre-compile time - specifies whether the configuration parameter shall be of configuration class *Pre-compile time* or not

Label	Description
x	The configuration parameter shall be of configuration class <i>Pre-compile time</i> .
--	The configuration parameter shall never be of configuration class <i>Pre-compile time</i> .

Link time - specifies whether the configuration parameter shall be of configuration class *Link time* or not

Label	Description
x	The configuration parameter shall be of configuration class <i>Link time</i> .
--	The configuration parameter shall never be of configuration class <i>Link time</i> .

Post Build - specifies whether the configuration parameter shall be of configuration class *Post Build* or not

Label	Description
x	The configuration parameter shall be of configuration class <i>Post Build</i> and no specific implementation is required.
L	<i>Loadable</i> - the configuration parameter shall be of configuration class <i>Post Build</i> and only one configuration parameter set resides in the ECU.
M	<i>Multiple</i> - the configuration parameter shall be of configuration class <i>Post Build</i> and is selected out of a set of multiple parameters by passing a dedicated pointer to the init function of the module.
--	The configuration parameter shall never be of configuration class <i>Post Build</i> .

10.2 Containers and configuration parameters

The following chapters summarize all configuration parameters. The detailed meanings of the parameters are described in Chapter 7 and Chapter 8. Further hardware / implementation specific parameters can be added if necessary.

10.2.1 Variants

SPI056: Variant PC: This variant is limited to pre-compile-configuration parameters only. The intention of this variant is to optimize the parameters configuration for a source code delivery.

SPI076: Variant LT: This variant allows a mix of pre-compile time-, link time-configuration parameters. The intention of this variant is to optimize the parameters configuration for an object code delivery.

SPI148: Variant PB: This variant allows a mix of pre-compile time-, post build-time configuration parameters. The intention of this variant is to optimize the parameters configuration for a re-loadable binary.

SPI234: The initialization function of this module shall always have a pointer as a parameter, even though for Variant PC no configuration set shall be given. Instead a NULL pointer shall be passed to the initialization function.

SPI235: If not applicable, the SPI Handler/Driver module's environment shall pass a NULL pointer to the function Spi_Init.

SpiGeneral

SWS Item	SPI225 :		
Container Name	SpiGeneral		
Description	General configuration settings for SPI-Handler		
Configuration Parameters			

SWS Item	SPI226 :		
Name	SpiCancelApi {SPI_CANCEL_API}		
Description	Switches the Spi_Cancel function ON or OFF.		
Multiplicity	1		
Type	BooleanParamDef		
Default value	--		
ConfigurationClass	Pre-compile time	X	All Variants
	Link time	--	
	Post-build time	--	
Scope / Dependency	scope: module		

SWS Item	SPI227 :		
Name	SpiChannelBuffersAllowed {SPI_CHANNEL_BUFFERS_ALLOWED}		
Description	Selects the SPI Handler/Driver Channel Buffers usage allowed and delivered.		
Multiplicity	1		

Type	IntegerParamDef		
Range	0 .. 2		
Default value	--		
ConfigurationClass	Pre-compile time	X	All Variants
	Link time	--	
	Post-build time	--	
Scope / Dependency	scope: module		

SWS Item	SPI228 :		
Name	SpiDevErrorDetect {SPI_DEV_ERROR_DETECT}		
Description	Switches the Development Error Detection and Notification ON or OFF.		
Multiplicity	1		
Type	BooleanParamDef		
Default value	--		
ConfigurationClass	Pre-compile time	X	All Variants
	Link time	--	
	Post-build time	--	
Scope / Dependency	scope: module		

SWS Item	SPI229 :		
Name	SpiHwStatusApi {SPI_HW_STATUS_API}		
Description	Switches the Spi_GetHWUnitStatus function ON or OFF.		
Multiplicity	1		
Type	BooleanParamDef		
Default value	--		
ConfigurationClass	Pre-compile time	X	All Variants
	Link time	--	
	Post-build time	--	
Scope / Dependency	scope: module		

SWS Item	SPI230 :		
Name	SpiInterruptibleSeqAllowed {SPI_INTERRUPTIBLE_SEQ_ALLOWED}		
Description	Switches the Interruptible Sequences handling functionality ON or OFF.		
Multiplicity	1		
Type	BooleanParamDef		
Default value	--		
ConfigurationClass	Pre-compile time	X	All Variants
	Link time	--	
	Post-build time	--	
Scope / Dependency	scope: module dependency: This parameter depends on SPI_LEVEL_DELIVERED value. It is only used for SPI_LEVEL_DELIVERED configured to 1 or 2.		

SWS Item	SPI231 :		
Name	SpiLevelDelivered {SPI_LEVEL_DELIVERED}		
Description	Selects the SPI Handler/Driver level of scalable functionality that is available and delivered.		
Multiplicity	1		
Type	IntegerParamDef		
Range	0 .. 2		
Default value	--		
ConfigurationClass	Pre-compile time	X	All Variants
	Link time	--	
	Post-build time	--	
Scope / Dependency	scope: module		

SWS Item	SPI232 :		
Name	SpiVersionInfoApi {SPI_VERSION_INFO_API}		
Description	Switches the Spi_GetVersionInfo function ON or OFF.		
Multiplicity	1		
Type	BooleanParamDef		
Default value	--		
ConfigurationClass	Pre-compile time	X	All Variants
	Link time	--	
	Post-build time	--	
Scope / Dependency	scope: module		

No Included Containers

SpiSequence

SWS Item	SPI106 :		
Container Name	SpiSequence{SpiSequenceConfiguration}		
Description	All data needed to configure one SPI-sequence		
Configuration Parameters			

SWS Item	SPI222 :		
Name	SpiInterruptibleSequence {SPI_INTERRUPTIBLE_SEQUENCE}		
Description	This parameter allows or not this Sequence to be suspended by another one.		
Multiplicity	1		
Type	BooleanParamDef		
Default value	--		
ConfigurationClass	Pre-compile time	X	VARIANT-PRE-COMPILE
	Link time	X	VARIANT-LINK-TIME
	Post-build time	X	VARIANT-POST-BUILD
Scope / Dependency	scope: module dependency: This SPI_INTERRUPTIBLE_SEQ_ALLOWED parameter as to be configured as ON.		

SWS Item	SPI223 :		
Name	SpiSeqEndNotification {SPI_SEQ_END_NOTIFICATION}		
Description	This parameter is a reference to a notification function.		
Multiplicity	1		
Type	FunctionNameDef		
Default value	--		
ConfigurationClass	Pre-compile time	X	VARIANT-PRE-COMPILE
	Link time	X	VARIANT-LINK-TIME
	Post-build time	X	VARIANT-POST-BUILD
Scope / Dependency	scope: ECU		

SWS Item	SPI224 :		
Name	SpiSequenceId {SPI_SEQUENCE_NAME}		
Description	--		
Multiplicity	1		
Type	IntegerParamDef (Symbolic Name generated for this parameter)		
Default value	--		
ConfigurationClass	Pre-compile time	X	All Variants
	Link time	--	
	Post-build time	--	

Scope / Dependency	scope: ECU
---------------------------	------------

SWS Item	SPI221 :		
Name	JobAssignment {SPI_JOB_LINKING}		
Description	A sequence references several jobs, which are executed during a communication sequence		
Multiplicity	1..*		
Type	Reference to SpiJob		
ConfigurationClass	Pre-compile time	X	VARIANT-PRE-COMPILE
	Link time	X	VARIANT-LINK-TIME
	Post-build time	X	VARIANT-POST-BUILD
Scope / Dependency	scope: ECU		

No Included Containers

SpiChannel

SWS Item	SPI104 :		
Container Name	SpiChannel{SpiChannelConfiguration}		
Description	All data needed to configure one SPI-channel		
Configuration Parameters			

SWS Item	SPI200 :		
Name	SpiChannelId {SPI_CHANNEL_NAME}		
Description	--		
Multiplicity	1		
Type	IntegerParamDef (Symbolic Name generated for this parameter)		
Default value	--		
ConfigurationClass	Pre-compile time	X	All Variants
	Link time	--	
	Post-build time	--	
Scope / Dependency	scope: ECU		

SWS Item	SPI201 :		
Name	SpiChannelType {SPI_CHANNEL_TYPE}		
Description	Buffer usage with EB/IB channel		
Multiplicity	1		
Type	EnumerationParamDef		
Range	EB	External Buffer	
	IB	SPI Handler/Driver Internal Buffer	
ConfigurationClass	Pre-compile time	X	VARIANT-PRE-COMPILE
	Link time	X	VARIANT-LINK-TIME
	Post-build time	X	VARIANT-POST-BUILD
Scope / Dependency	scope: ECU dependency: SPI_CHANNEL_BUFFERS_ALLOWED		

SWS Item	SPI202 :		
Name	SpiDataWidth {SPI_DATA_WIDTH}		
Description	This parameter is the width of a transmitted data unit.		
Multiplicity	1		
Type	IntegerParamDef		
Range	1 .. 32		
Default value	--		
ConfigurationClass	Pre-compile time	X	VARIANT-PRE-COMPILE
	Link time	X	VARIANT-LINK-TIME

	Post-build time	X	VARIANT-POST-BUILD
Scope / Dependency	scope: module		

SWS Item	SPI203 :		
Name	SpiDefaultData {SPI_DEFAULT_DATA}		
Description	This parameter is the default value to transmit.		
Multiplicity	1		
Type	IntegerParamDef		
Default value	--		
ConfigurationClass	Pre-compile time	X	VARIANT-PRE-COMPILE
	Link time	X	VARIANT-LINK-TIME
	Post-build time	X	VARIANT-POST-BUILD
Scope / Dependency	scope: module		

SWS Item	SPI204 :		
Name	SpiEbMaxLength {SPI_EB_MAX_LENGTH}		
Description	This parameter contains the maximum size of data buffers in case of EB Channels and only.		
Multiplicity	1		
Type	IntegerParamDef		
Default value	--		
ConfigurationClass	Pre-compile time	X	VARIANT-PRE-COMPILE
	Link time	X	VARIANT-LINK-TIME
	Post-build time	X	VARIANT-POST-BUILD
Scope / Dependency	scope: module dependency: The SPI_CHANNEL_TYPE parameter has to be configured as EB for this Channel. The SPI_CHANNEL_BUFFERS_ALLOWED parameter has to be configured as 1 or 2.		

SWS Item	SPI205 :		
Name	SpiIbNBuffers {SPI_IB_N_BUFFERS}		
Description	This parameter contains the maximum number of data buffers in case of IB Channels and only.		
Multiplicity	1		
Type	IntegerParamDef		
Default value	--		
ConfigurationClass	Pre-compile time	X	VARIANT-PRE-COMPILE
	Link time	X	VARIANT-LINK-TIME
	Post-build time	X	VARIANT-POST-BUILD
Scope / Dependency	scope: module dependency: The SPI_CHANNEL_TYPE parameter has to be configured as IB for this Channel. The SPI_CHANNEL_BUFFERS_ALLOWED parameter has to be configured as 0 or 2.		

SWS Item	SPI206 :		
Name	SpiTransferStart {SPI_TRANSFER_START}		
Description	This parameter defines the first starting bit for transmission.		
Multiplicity	1		
Type	EnumerationParamDef		
Range	LSB	Transmission starts with the Least Significant Bit first	
	MSB	Transmission starts with the Most Significant Bit first	
ConfigurationClass	Pre-compile time	X	VARIANT-PRE-COMPILE
	Link time	X	VARIANT-LINK-TIME
	Post-build time	X	VARIANT-POST-BUILD
Scope / Dependency	scope: module		

No Included Containers
SpiJob

SWS Item	SPI105 :
Container Name	SpiJob{SpiJobConfiguration}
Description	All data needed to configure one SPI-Job, amongst others the connection between the internal SPI unit and the special settings for an external device is done.
Configuration Parameters	

SWS Item	SPI217 :		
Name	SpiHwUnit {SPI_HW_UNIT}		
Description	This parameter is the symbolic name to identify the HW SPI Hardware micro-controller peripheral allocated to this Job.		
Multiplicity	1		
Type	EnumerationParamDef		
Range	CSIB0	--	
	CSIB1	--	
	CSIB2	--	
	CSIB3	--	
ConfigurationClass	Pre-compile time	X	VARIANT-PRE-COMPILE
	Link time	X	VARIANT-LINK-TIME
	Post-build time	X	VARIANT-POST-BUILD
Scope / Dependency	scope: module		

SWS Item	SPI218 :		
Name	SpiJobEndNotification {SPI_JOB_END_NOTIFICATION}		
Description	This parameter is a reference to a notification function.		
Multiplicity	1		
Type	FunctionNameDef		
Default value	--		
ConfigurationClass	Pre-compile time	X	VARIANT-PRE-COMPILE
	Link time	X	VARIANT-LINK-TIME
	Post-build time	X	VARIANT-POST-BUILD
Scope / Dependency	scope: module		

SWS Item	SPI219 :		
Name	SpiJobId {SPI_JOB_NAME}		
Description	--		
Multiplicity	1		
Type	IntegerParamDef (Symbolic Name generated for this parameter)		
Default value	--		
ConfigurationClass	Pre-compile time	X	All Variants
	Link time	--	
	Post-build time	--	
Scope / Dependency	scope: ECU		

SWS Item	SPI220 :		
Name	SpiJobPriority {SPI_JOB_PRIORITY}		
Description	Priority of the Job		
Multiplicity	1		
Type	IntegerParamDef		
Range	0 .. 3		

Default value	--		
ConfigurationClass	Pre-compile time	X	VARIANT-PRE-COMPILE
	Link time	X	VARIANT-LINK-TIME
	Post-build time	X	VARIANT-POST-BUILD
Scope / Dependency	scope: module		

SWS Item	SPI215 :		
Name	ChannelAssignment {SPI_CHANNEL_LINKING}		
Description	A job references several channels.		
Multiplicity	1..*		
Type	Reference to SpiChannel		
ConfigurationClass	Pre-compile time	X	VARIANT-PRE-COMPILE
	Link time	X	VARIANT-LINK-TIME
	Post-build time	X	VARIANT-POST-BUILD
Scope / Dependency	scope: ECU		

SWS Item	SPI216 :		
Name	DeviceAssignment		
Description	Reference to the external device used by this job		
Multiplicity	1		
Type	Reference to SpiExternalDevice		
ConfigurationClass	Pre-compile time	--	
	Link time	--	
	Post-build time	--	
Scope / Dependency			

No Included Containers

SpiExternalDevice

SWS Item	SPI207 :		
Container Name	SpiExternalDevice		
Description	The communication settings of an external device. Closely linked to Spi-Job.		
Configuration Parameters			

SWS Item	SPI208 :		
Name	SpiBaudrate {SPI_BAUDRATE}		
Description	This parameter is the communication baudrate - This parameter allows using a range of values, from the point of view of configuration tools, from Hz up to MHz.		
Multiplicity	1		
Type	FloatParamDef		
Default value	--		
ConfigurationClass	Pre-compile time	X	VARIANT-PRE-COMPILE
	Link time	X	VARIANT-LINK-TIME
	Post-build time	X	VARIANT-POST-BUILD
Scope / Dependency	scope: module		

SWS Item	SPI209 :		
Name	SpiCsIdentifier {SPI_CS_IDENTIFIER}		
Description	This parameter is the symbolic name to identify the Chip Select (CS) allocated to this Job.		
Multiplicity	1		
Type	StringParamDef (Symbolic Name generated for this parameter)		

Default value	--		
ConfigurationClass	Pre-compile time	X	VARIANT-PRE-COMPILE
	Link time	X	VARIANT-LINK-TIME
	Post-build time	X	VARIANT-POST-BUILD
Scope / Dependency	scope: module		

SWS Item	SPI210 :		
Name	SpiCsPolarity {SPI_CS_POLARITY}		
Description	This parameter defines the active polarity of Chip Select.		
Multiplicity	1		
Type	EnumerationParamDef		
Range	HIGH	--	
	LOW	--	
ConfigurationClass	Pre-compile time	X	VARIANT-PRE-COMPILE
	Link time	X	VARIANT-LINK-TIME
	Post-build time	X	VARIANT-POST-BUILD
Scope / Dependency	scope: module		

SWS Item	SPI211 :		
Name	SpiDataShiftEdge {SPI_DATA_SHIFT_EDGE}		
Description	This parameter defines the SPI data shift edge.		
Multiplicity	1		
Type	EnumerationParamDef		
Range	LEADING	--	
	TRAILING	--	
ConfigurationClass	Pre-compile time	X	VARIANT-PRE-COMPILE
	Link time	X	VARIANT-LINK-TIME
	Post-build time	X	VARIANT-POST-BUILD
Scope / Dependency	scope: module		

SWS Item	SPI212 :		
Name	SpiEnableCs {SPI_ENABLE_CS}		
Description	This parameter enables or not the Chip Select handling functions.		
Multiplicity	1		
Type	BooleanParamDef		
Default value	--		
ConfigurationClass	Pre-compile time	X	VARIANT-PRE-COMPILE
	Link time	X	VARIANT-LINK-TIME
	Post-build time	X	VARIANT-POST-BUILD
Scope / Dependency	scope: module		

SWS Item	SPI213 :		
Name	SpiShiftClockIdleLevel {SPI_SHIFT_CLOCK_IDLE_LEVEL}		
Description	This parameter defines the SPI shift clock idle level.		
Multiplicity	1		
Type	EnumerationParamDef		
Range	HIGH	--	
	LOW	--	
ConfigurationClass	Pre-compile time	X	VARIANT-PRE-COMPILE
	Link time	X	VARIANT-LINK-TIME
	Post-build time	X	VARIANT-POST-BUILD
Scope / Dependency	scope: module		

SWS Item	SPI214 :		
-----------------	-----------------	--	--

Name	SpiTimeClk2Cs {SPI_TIME_CLK2CS}		
Description	Timing between clock and chip select - This parameter allows to use a range of values from 0 up to 100 microSec. the real configuration-value used in software BSW-SPI is calculated out of this by the generator-tools		
Multiplicity	1		
Type	FloatParamDef		
Range	0.0 .. 100.0		
Default value	--		
ConfigurationClass	Pre-compile time	X	VARIANT-PRE-COMPILE
	Link time	X	VARIANT-LINK-TIME
	Post-build time	X	VARIANT-POST-BUILD
Scope / Dependency	scope: module		

No Included Containers

10.2.2 SpiDriver

SWS Item	SPI091 :		
Container Name	SpiDriver{SpiDriverConfiguration} [Multi Config Container]		
Description	--		
Configuration Parameters			

SWS Item	SPI197 :		
Name	SpiMaxChannel {SPI_MAX_CHANNEL}		
Description	This parameter contains the number of Channels configured. It will be gathered by tools during the configuration stage.		
Multiplicity	0..1		
Type	IntegerParamDef		
Default value	--		
ConfigurationClass	Pre-compile time	X	VARIANT-PRE-COMPILE
	Link time	X	VARIANT-LINK-TIME
	Post-build time	X	VARIANT-POST-BUILD
Scope / Dependency			

SWS Item	SPI198 :		
Name	SpiMaxJob {SPI_MAX_JOB}		
Description	--		
Multiplicity	0..1		
Type	IntegerParamDef		
Default value	--		
ConfigurationClass	Pre-compile time	X	VARIANT-PRE-COMPILE
	Link time	X	VARIANT-LINK-TIME
	Post-build time	X	VARIANT-POST-BUILD
Scope / Dependency			

SWS Item	SPI199 :		
Name	SpiMaxSequence {SPI_MAX_SEQUENCE}		
Description	--		
Multiplicity	0..1		
Type	IntegerParamDef		
Default value	--		
ConfigurationClass	Pre-compile time	X	VARIANT-PRE-COMPILE
	Link time	X	VARIANT-LINK-TIME
	Post-build time	X	VARIANT-POST-BUILD
Scope / Dependency			

Included Containers		
Container Name	Multiplicity	Scope / Dependency
SpiChannel	1..*	All data needed to configure one SPI-channel
SpiExternalDevice	1..*	The communication settings of an external device. Closely linked to SpiJob.
SpiJob	1..*	All data needed to configure one SPI-Job, amongst others the connection between the internal SPI unit and the special settings for an external device is done.
SpiSequence	1..*	All data needed to configure one SPI-sequence

10.3 Published parameters

SPI089: The following table specifies information that is published in the module's header file `Spi.h` or in the module's description file. Published information contains data defined by the implementer of the SW module that does not change when the module is adapted (i.e. configured) to the actual HW/SW environment. It thus contains version and manufacturer information.

SPI068: This published information is provided in the module's description for use by configuration tools. Further hardware / implementation specific parameters can be added if necessary.

The standard common published information like

```
vendorId (<Module>_VENDOR_ID),
moduleId (<Module>_MODULE_ID),
arMajorVersion (<Module>_AR_MAJOR_VERSION),
arMinorVersion (<Module>_AR_MINOR_VERSION),
arPatchVersion (<Module>_AR_PATCH_VERSION),
swMajorVersion (<Module>_SW_MAJOR_VERSION),
swMinorVersion (<Module>_SW_MINOR_VERSION),
swPatchVersion (<Module>_SW_PATCH_VERSION),
vendorApiInfix (<Module>_VENDOR_API_INFIX)
```

is provided in the BSW Module Description Template (see [11] Figure 4.1 and Figure 7.1).

Additional published parameters are listed below if applicable for this module.

10.4 Configuration concept

There is a relationship between the SPI Handler/Driver module and the modules that use it. This relationship is resolved during the configuration stage and the result of it influences the proper API and behaviour between those modules.

The user needs to provide to the SPI Handler/Driver part of the configuration to adapt it to its necessities. The SPI Handler/Driver shall take this configuration and provide the needed tools to the user.

The picture shows the information flow during the configuration of the SPI Handler/Driver. It is shown only for one user, using an External EEPROM Driver as example, but this situation is common to all users of the SPI Handler/Driver. To highlight the situation where more users are affected, several overlapping documents are drawn.

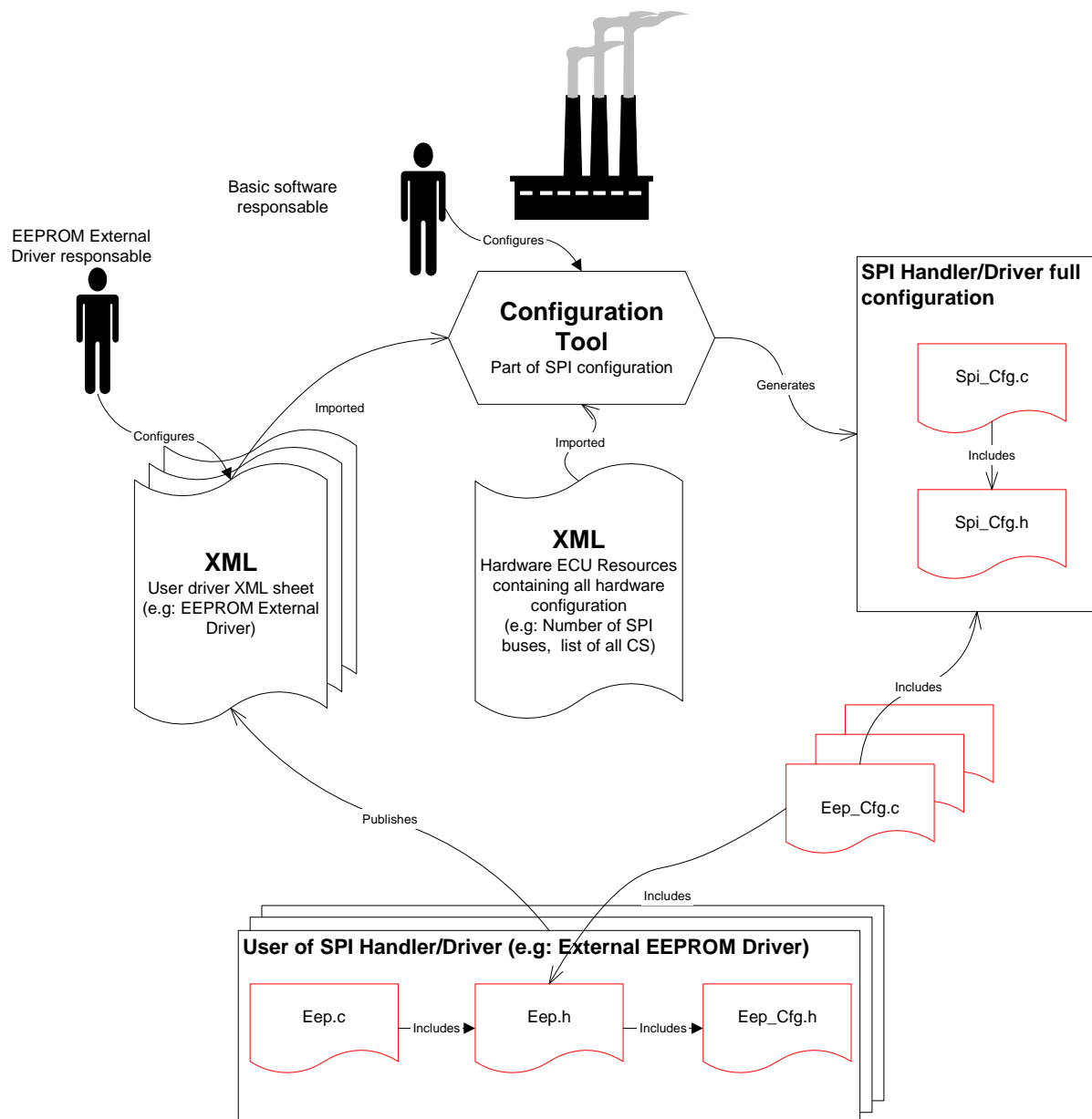

The steps on the diagrams are:

1. The user (External EEPROM Driver) of SPI Handler/Driver edits a XML configuration file. This XML configuration file is the same used by the user to generate its own configuration.
2. For each ECU, a XML HW configuration document contains information which should be used in order to configure some parameters.
3. The “SPI generation tool”. The Generation tool (here is reflected only the part that generates code to SPI usage) shall generate the handles to export and the instance of the configuration sets. In this step the software integrator will provide missing information.
4. SPI instance configuration file. As a result of the generation all the symbolic handlers needed by the user are included in the configuration header file of the SPI Handler/Driver.
5. User gets the symbolic name of handlers. User imports the handle generated to make use of them as requested by its XML configuration file.

11 Appendix

The table shown on the next page is just an example to help future users (and/or developers) that have to configure software modules to use the SPI Handler/Driver. This table is independent of the `Spi_ConfigType` structure but contains all elements and aggregations like Channels, Jobs and Sequences.

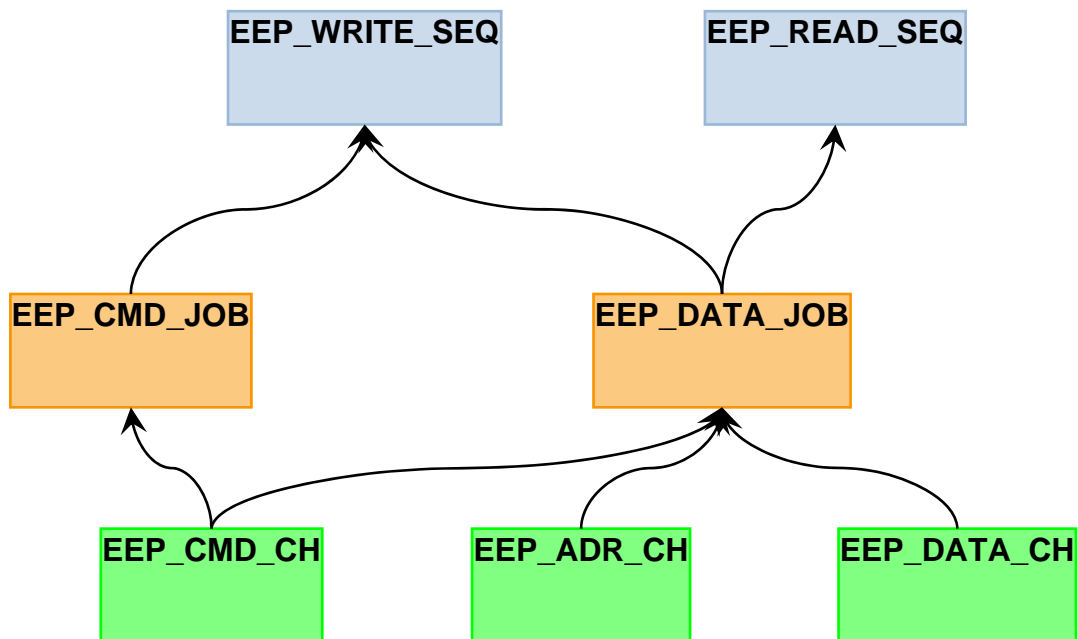

External EEPROM Write/Read Configuration for SPI Handler/Driver								
Sequences			Jobs			Channels		
Symbolic Name	ID	Attributes	Symbolic Name	ID	Attributes	Symbolic Name	ID	Attributes
EEP_WRITE_SEQ	0	2 (Number of Jobs), {EEP_CMD_JOB, EEP_DATA_JOB} (List of Jobs), Not Interruptible, EEP_vidEndOfWriteSeq	EEP_CMD_JOB	0	SPI_BUS_0, CS_EEPROM, CS_ON, CS_LOW, CLK_2MHz, 1 (time in μs), Polarity 180, Falling Edge, 3, EEP_vidEndOfStartWrJob, 1 (Number of Channels) {EEP_CMD_CH} (List of Chan- nels)	EEP_CMD_CH	0	EB, 8 bits, 1 data to TxD, MSB First, Default value is 0x00
EEP_READ_SEQ	1	1 (Number of Jobs), {EEP_DATA_JOB} (List of Jobs), Not Interruptible, EEP_vidEndOfReadSeq	EEP_DATA_JOB	1	SPI_BUS_0, CS_EEPROM, CS_ON, CS_LOW, CLK_2MHz, 1 (time in μs), Polarity 180, Falling Edge, 2, NULL, 3 (Number of Channels) {EEP_CMD_CH, EEP_ADR_CH, EEP_DATA_CH} (List of Chan- nels)	EEP_ADR_CH	1	EB, 16 bits, 1 data to TxD, MSB First, Default value is 0x0000
						EEP_DATA_CH	2	EB, 8 bits, 32 data to TxD, MSB First, Default value is 0x00

12 Changes to Release 1

12.1 Deleted SWS Items

<i>SWS Item</i>	<i>Rationale</i>
SPI090	Redundant with the new version of SPI089

12.2 Replaced SWS Items

<i>SWS Item of Release 1</i>	<i>replaced by SWS Item</i>	<i>Rationale</i>
SPI056	<u>SPI056</u> , <u>SPI103</u>	To split the old requirement into two requirements to fit to the new SWS template with containers and variants.
SPI053	<u>SPI053</u> , <u>SPI112</u>	To split the old requirement into two requirements to improve the testability. Description for the maximum size of External Buffers.

12.3 Changed SWS Items

<i>SWS Item</i>	<i>Rationale</i>
<u>SPI089</u>	To take in account the new template sentence to describe requirement.
<u>SPI029</u>	To take in account the new template location and sentence to describe requirement.
<u>SPI092</u>	Clarify the structure of includes files as described in new template.
<u>SPI076</u>	To take in account the new SWS template with variants.
<u>SPI091</u>	To take in account the new SWS template with containers definitions.
<u>SPI001</u>	To take in account the scalability with Levels of Functionalities concept.
<u>SPI014</u>	Improvement for interruptible sequences behavior.
<u>SPI021</u>	Changes according to a bug from Bugzilla accepted.
<u>SPI052</u>	Changes according to a bug from Bugzilla accepted.
<u>SPI031</u> , <u>SPI032</u> , <u>SPI060</u> , <u>SPI046</u>	Changes to fulfill BSW12448
<u>SPI103</u>	After creation, add of new parameters for pre-compile time configuration
<u>SPI044</u>	Changed to fulfill a requirement concerning object code delivery
<u>SPI085</u>	To add new interfaces
<u>SPI020</u>	Delete the Job result setting from this service.
<u>SPI094</u>	Fulfill the SWS template

12.4 Added SWS Items

<i>SWS Item</i>	<i>Rationale</i>
<u>SPI094</u>	Additional requirement to identify the table of published parameters and creation of new parameters.
<u>SPI095</u>	New item to fulfill the required code file structure.
<u>SPI096</u>	New item to describe the relationship with the Dem module.
<u>SPI097</u>	New item to describe Dem Ids allocation rules.
<u>SPI098</u>	Clarify development errors C type.
<u>SPI099</u>	New requirement to the production errors detection.
<u>SPI100</u>	Clarify development errors reporting.
<u>SPI101</u>	New item for Spi_GetVersionInfo service description.
<u>SPI102</u>	New item for Spi_GetVersionInfo configuration rules.

<u>SPI104</u>	Creation of SpiChannel container with all its parameters.
<u>SPI105</u>	Creation of SpiJobConfiguration container with all its parameters.
<u>SPI106</u>	Creation of SpiSequence with all its parameters.
<u>SPI107</u>	Introduction of the selectable levels of functionalities concept.
<u>SPI108</u>	Restriction to LEVEL 2 usage at microcontrollers with more than 1 SPI bus.
<u>SPI109</u>	The level is selected at pre-compile time.
<u>SPI110</u>	Define the parameter to configure level of functionality.
<u>SPI111</u>	Define the parameter to configure buffers usage IB / EB / Both.
<u>SPI113</u>	Global requirement for the LEVEL 0 synchronous behavior.
<u>SPI114</u>	Multiple sequences transmission restriction for synchronous level.
<u>SPI115</u>	Requirement to include buffers usage in LEVEL 0.
<u>SPI116</u>	Multiple sequences transmission acceptance rule for asynchronous level.
<u>SPI117</u>	Requirement to include buffers usage and interruptible sequences in LEVEL 1.
<u>SPI118</u>	Requirement for End Notification Function.
<u>SPI119</u>	Additional requirement for Job end notification.
<u>SPI120</u>	Additional requirement for Sequence end notification.
<u>SPI121</u>	Define the parameter to configure interruptible sequences.
<u>SPI122</u>	Description of behavior in case of interruptible sequences disabled.
<u>SPI123</u>	Additional requirement in case of interruptible sequences disabled.
<u>SPI124</u>	Additional requirement in case of interruptible sequences disabled.
<u>SPI125</u>	Description of behavior in case of interruptible sequences enabled.
<u>SPI126</u>	Additional requirement in case of interruptible sequences enabled.
<u>SPI127</u>	Additional requirement in case of interruptible sequences enabled.
<u>SPI128</u>	Global requirement for the LEVEL 2 synchronous and asynchronous behavior.
<u>SPI129</u>	Description for the prearrange SPI bus for synchronous transmissions..
<u>SPI130</u>	Description of a so-called synchronous sequence.
<u>SPI131</u>	Restrictions to Jobs linkage within a Sequence.
<u>SPI132</u>	Applicability of requirements coming from LEVEL 0 and LEVEL 1.
<u>SPI133</u>	<code>Spi_AsyncTransmit()</code> configuration dependance.
<u>SPI134</u>	<code>Spi_SyncTransmit()</code> main behavior requirement.
<u>SPI135</u>	<code>Spi_SyncTransmit()</code> re-entrance behavior requirement.
<u>SPI136</u>	<code>Spi_SyncTransmit()</code> configuration dependance.
<u>SPI137</u>	<code>Spi_WriteIB()</code> configuration dependance.
<u>SPI138</u>	<code>Spi_ReadIB()</code> configuration dependance.
<u>SPI139</u>	<code>Spi_SetupEB()</code> configuration dependance.
<u>SPI141</u>	Creation of API interface <code>Spi_GetHWUnitStatus</code> to get the status of a specified SPI Hardware microcontroller peripheral (unit)
<u>SPI142</u>	<code>Spi_GetHWUnitStatus()</code> configuration dependance.
<u>SPI143</u>	Creation in order to fulfill BSW12448
<u>SPI144</u>	Creation of API interface <code>Spi_Cancel</code> to stop a specified Sequence transmission.
<u>SPI145</u>	Additional requirement for end sequence notification in case of cancelling.
<u>SPI146</u>	<code>Spi_Cancel()</code> configuration dependance.
<u>SPI147</u>	Additional requirement for checking API parameter and what should be done in case of error
<u>SPI148</u>	Creation of a dedicated variant for post build-time parameters.
<u>SPI149</u>	Global requirement concerning data width handled by HW and data type given by users.
<u>SPI150</u>	Creation of API type <code>Spi_AsyncModeType</code> configurable at pre-compile time
<u>SPI151</u>	Additional requirement to the service in order to cover the polling or interrupt handling at initialisation for LEVEL 2.
<u>SPI152</u>	Creation of API interface <code>Spi_SetAsyncMode</code> to set the asynchronous mechanism mode.
<u>SPI153</u>	Additional requirement in case of setting mode while SPI Handler/Driver is

	busy.
<u>SPI154</u>	<code>Spi_SetAsyncMode()</code> configuration dependance.
<u>SPI155</u>	Requirement to include both polling and interrupt asynchronous mechanisms in LEVEL 2.
<u>SPI156</u>	Additional requirement to have selectable modes during execution time.
<u>SPI157</u>	Additional requirement for asynchronous transmissions of Jobs and specially for setting their results.

13 Changes during SWS Improvements by Technical Office

13.1 Deleted SWS Items

<i>SWS Item</i>	<i>Rationale</i>
SPI079	Not a requirement but an example (sequence diagram)
SPI147	Redundant to SPI032

13.2 Replaced SWS Items

<i>SWS Item of Release 1</i>	<i>replaced by SWS Item</i>	<i>Rationale</i>
SPI096	SPI158 , SPI159	Splitting because original requirement was on different objects.
SPI113	SPI160 , SPI161	Splitting because original requirement was on different issues.
SPI001	SPI162 , SPI163	Splitting because original requirement was on different issues.
SPI153	SPI171 , SPI172	Splitting because for better distinction between modes
SPI070	SPI174	Replaced by UML Model linking of imported types

13.3 Changed SWS Items

Many requirements have been changed to improve understandability without changing the technical contents.

13.4 Added SWS Items

<i>SWS Item</i>	<i>Rationale</i>
SPI164	Definition of Spi_DataType
SPI165	Definition of Spi_NumberOfDataType
SPI166	Definition of Spi_ChannelType
SPI167	Definition of Spi_JobType
SPI168	Definition of Spi_SequenceType
SPI169	Definition of Spi_HWUnitType
SPI170	Definition of Spi_AsyncModeType
SPI173	Requirement had no ID
SPI175	UML Model linking of Spi_Init
SPI176	UML Model linking of Spi_DeInit
SPI177	UML Model linking of Spi_WriteIB
SPI178	UML Model linking of Spi_AsyncTransmit
SPI179	UML Model linking of Spi_ReadIB
SPI180	UML Model linking of Spi_SetupEB
SPI181	UML Model linking of Spi_GetStatus
SPI182	UML Model linking of Spi_GetJobResult
SPI183	UML Model linking of Spi_GetSequenceResult
SPI184	UML Model linking of Spi_GetVersionInfo

<u>SPI185</u>	UML Model linking of Spi_SyncTransmit
<u>SPI186</u>	UML Model linking of Spi_GetHWUnitStatus
<u>SPI187</u>	UML Model linking of Spi_Cancel
<u>SPI188</u>	UML Model linking of Spi_SetAsyncMode
<u>SPI189</u>	UML Model linking of Spi_MainFunction_Handling
<u>SPI190</u>	UML Model linking of Spi_MainFunction_Driving
<u>SPI191</u>	UML Model linking of the optional interfaces
<u>SPI192</u>	UML Model linking of Spi_JobEndNotification
<u>SPI193</u>	UML Model linking of Spi_SeqEndNotification
<u>SPI196</u>	Hint Spi_GetVersionInfo
<u>SPI233</u>	Requirement added for inclusion of development error SPI_E_ALREADY_INITIALIZED.
<u>SPI234</u>	Bug 18346: sentence agreed within SPAL, 2006-12-12
<u>SPI235</u>	Extension of SPI198