

| | |
|-----------------------------------|---|
| Document Title | Explanation of Application Interfaces of the Powertrain Engine Domain |
| Document Owner | AUTOSAR |
| Document Responsibility | AUTOSAR |
| Document Identification No | 269 |

| | |
|---------------------------------|------------------|
| Document Status | published |
| Part of AUTOSAR Standard | Classic Platform |
| Part of Standard Release | R21-11 |

| Document Change History | | | |
|--------------------------------|----------------|----------------------------|---|
| Date | Release | Changed by | Change Description |
| 2021-11-25 | R21-11 | AUTOSAR Release Management | <ul style="list-style-type: none"> No content changes |
| 2020-11-30 | R20-11 | AUTOSAR Release Management | <ul style="list-style-type: none"> Version update, No content changes |
| 2019-11-28 | R19-11 | AUTOSAR Release Management | <ul style="list-style-type: none"> Remove obsolete Reference [2] Table of Application Interfaces and change to [3] Update Table of Contents Update of figures to reflect the latest definitions of Transmission – Engine Interfaces Extension of chapter 3.1 by section “Consideration of the inertia in torque signals” Chapter 6.3.6: “Special rules for engine-transmission interfaces” modified Changed Document Status from Final to published |
| 2018-10-31 | 4.4.0 | AUTOSAR Release Management | <ul style="list-style-type: none"> Update of figures Chapter 7 deleted |

| Document Change History | | | |
|-------------------------|---------|------------|--|
| Date | Release | Changed by | Change Description |
| | | | <ul style="list-style-type: none"> • Chapter 3.5: Note to obsolete interfaces deleted • Figure 2: Torque Reserve concept with Fast and Slow torque requests: update picture – but no content change • Chapter 7: Correction of Correction of wrong Short Name of PtEngTqCrksftMinFast -> PtEngTqCluMinFast • Chapter 5.2: <ul style="list-style-type: none"> - Update of figure “Example of signal flow of gear signals during a single upshift or downshift”. • Chapter 3.2: <ul style="list-style-type: none"> - Figure 1: Modification of “Torque at engine clutch” to “Torque at crankshaft reduced by ancillary losses” - More detailed description of section “Ancillary torque losses”. • Chapter 6.3.6: Extension of the table by “Special rules for WP-TRSM specific signals”. • Figure 4: Correction of the wrong Short Name PtEngTqCrksftMinFast => PtEngTqCluMinFast. • Chapter 5.3.4 added: Timing- and Accuracy requirements to the signal “Engine Speed Including Start Stop”, necessary for transmission. |

| Document Change History | | | |
|--------------------------------|----------------|----------------------------|--|
| Date | Release | Changed by | Change Description |
| 2016-11-30 | 4.3.0 | AUTOSAR Release Management | <ul style="list-style-type: none"> • Chapters “Terminology – Torque within the Powertrain Domain” and “Overview of AUTOSAR torque application interfaces” updated by new torque signals requested by WP-I-TRSM. • Update Chapter “Appendix: Mapping Ports to Display Names - Powertrain Domain” according Sensor/Actuator Pattern Definitions. Keep elements from earlier AUTOSAR Releases inside. |
| 2015-07-31 | 4.2.2 | AUTOSAR Release Management | <ul style="list-style-type: none"> • Chapter “Timing and Accuracy Requirements to Torque Signals” and related figure removed and moved into description of related Interfaces in AI-Tool |
| 2014-10-31 | 4.2.1 | AUTOSAR Release Management | <ul style="list-style-type: none"> • Chapter “Sensor/Actuator Design Pattern” moved to new document “AIDesignPatternsCatalogue” • Integrate new interfaces / update existing interfaces for network representation of engine & transmission interfaces |
| 2013-10-31 | 4.1.2 | AUTOSAR Release Management | <ul style="list-style-type: none"> • Updated/Rework of Chapter “Sensor/Actuator Design Pattern” • Update of Chapter “Appendix: Mapping Ports to Display Names - Powertrain Domain” according to changes in application interfaces model or patterns |
| 2013-03-15 | 4.1.1 | AUTOSAR Administration | <ul style="list-style-type: none"> • New: chapter describing Sensor Actuator Design Pattern • Update w.r.t. to obsolete names etc. according to changes in AISpecification etc. |

| Document Change History | | | |
|--------------------------------|----------------|------------------------|--|
| Date | Release | Changed by | Change Description |
| 2011-12-22 | 4.0.3 | AUTOSAR Administration | <ul style="list-style-type: none"> • Splitting of document: Topic of Measurement and Calibration moved to new document TR_AIMeasurementCalibrationDiagnostics_537 • Update w.r.t. to names etc. according to changes in AISpecification |
| 2010-09-30 | 3.1.5 | AUTOSAR Administration | <ul style="list-style-type: none"> • Display names made consistent to AISpecification • Rule MCM390 added: Suffix should not exceed 3 char |
| 2010-02-02 | 3.1.4 | AUTOSAR Administration | <ul style="list-style-type: none"> • Added: overview figures of different torque interfaces • New: chapter about modeling aspects and automatic generation of display names • New: Mapping Ports to Display Names • Legal disclaimer revised |
| 2008-08-13 | 3.1.1 | AUTOSAR Administration | <ul style="list-style-type: none"> • Legal disclaimer revised |
| 2007-12-21 | 3.0.1 | AUTOSAR Administration | <ul style="list-style-type: none"> • Initial Release |

Disclaimer

This work (specification and/or software implementation) and the material contained in it, as released by AUTOSAR, is for the purpose of information only. AUTOSAR and the companies that have contributed to it shall not be liable for any use of the work. The material contained in this work is protected by copyright and other types of intellectual property rights. The commercial exploitation of the material contained in this work requires a license to such intellectual property rights.

This work may be utilized or reproduced without any modification, in any form or by any means, for informational purposes only. For any other purpose, no part of the work may be utilized or reproduced, in any form or by any means, without permission in writing from the publisher.

The work has been developed for automotive applications only. It has neither been developed, nor tested for non-automotive applications.

The word AUTOSAR and the AUTOSAR logo are registered trademarks.

Table of Contents

| | |
|--|----|
| 1 Purpose of this Document..... | 7 |
| 2 References | 8 |
| 3 Description of Terms and Concepts | 9 |
| 3.1 Abbreviations..... | 9 |
| 3.2 Terminology – Torque within the Powertrain Domain..... | 9 |
| 3.3 Terminology – Fast and Slow Torque Requests..... | 10 |
| 3.4 Typical combinations of signals for transmission shift intervention..... | 12 |
| 3.5 Overview of AUTOSAR torque application interfaces | 14 |
| 4 Architecture Overview | 20 |
| 5 Description of Exemplary Software Components | 21 |
| 5.1 Powertrain Coordinator – PTC (PtCoorr)..... | 21 |
| 5.2 Transmission System (Trsm) | 21 |
| 5.3 Combustion Engine (CmbEng) | 22 |
| 5.3.1 Engine Speed and Position (EngSpdAndPosn) | 22 |
| 5.3.2 Engine Torque Mode Management (EngTqModMngt)..... | 23 |
| 5.3.3 Combustion Engine: Miscellaneous (CmbEngMisc)..... | 23 |
| 5.3.4 Combustion Engine: Timing- and Accuracy requirements on the signal “Powertrain: Engine Speed Including Start Stop”, necessary for transmission. | 24 |
| 5.4 Vehicle Motion relevant for Powertrain (VehMtnForPt) | 26 |
| 5.4.1 Driver Request (DrvReq)..... | 26 |
| 5.4.2 Accelerator Pedal Position (AccrPedlPosn)..... | 27 |
| 5.4.3 Safety Vehicle Speed Limitation (VehSpdLimnForSfty) | 27 |
| 5.4.4 Vehicle Motion (Powertrain): Miscellaneous (VehMtnForPtMisc) | 27 |
| 5.5 Powertrain: Miscellaneous (PtMisc)..... | 27 |
| 6 Additional Information | 28 |
| 6.1 Differences between SW-Cs and ECUs | 28 |
| 6.2 Functional safety | 28 |
| 6.3 Powertrain Application Interfaces - Decisions / Assumptions | 28 |
| 6.3.1 Scope | 28 |
| 6.3.2 PTC Composition (PtCoorr) | 28 |
| 6.3.3 Definition of overboost | 28 |
| 6.3.4 Coordination at the vehicle level | 29 |
| 6.3.5 PTC Arbitration between Driver and Chassis torque requests..... | 29 |
| 6.3.6 Assumptions on modeling style and naming aspects specific for powertrain domain..... | 30 |

1 Purpose of this Document

This document explains design decisions that lead to the standardized applications interfaces relevant to the Powertrain Domain.

The sensor actuator pattern described in this document is not specific to the powertrain domain but can be applied to other domains too, e.g. the chassis domain.

***NOTE:** If any information in diagrams or text (or conclusions drawn from them) conflict with the information in [3] or [3b] and this is not explicitly mentioned the information in [3] or [3b], resp., should be regarded as definitive.*

2 References

- [1] SW-C and System Modeling Guide
AUTOSAR_TR_SW-CModelingGuide
- [3] XML Specification of Application Interfaces
AUTOSAR_MOD_AISpecification
- [3b] Application Interfaces Examples
AUTOSAR_MOD_AISpecificationExamples
- [4] Explanation of Application Interfaces of the Chassis Domain
AUTOSAR_EXP_AIChassisExplanation
- [5] Unique Names for Documentation, Measurement and Calibration: Modeling and Naming Aspects including Automatic Generation
AUTOSAR_TR_AIMeasurementCalibrationDiagnostics
- [6] Software Component Template
AUTOSAR_TPS_SoftwareComponentTemplate
- [7] Standardization Template
AUTOSAR_TPS_StandardizationTemplate
- [8] ANTLR parser generator V3
<http://www.antlr.org>
- [9] Virtual Function Bus
AUTOSAR_EXP_VFB
- [10] Glossary
AUTOSAR_TR_Glossary
- [11] AIDesignPatternCatalogue
AUTOSAR_TR_AIDesignPatternCatalogue

3 Description of Terms and Concepts

3.1 Abbreviations

For abbreviations used in this document please refer to the keyword list in [3] (as .arxml).

Additionally, please also refer to [10] for explanation of commonly used terms and abbreviations within AUTOSAR.

3.2 Terminology – Torque within the Powertrain Domain

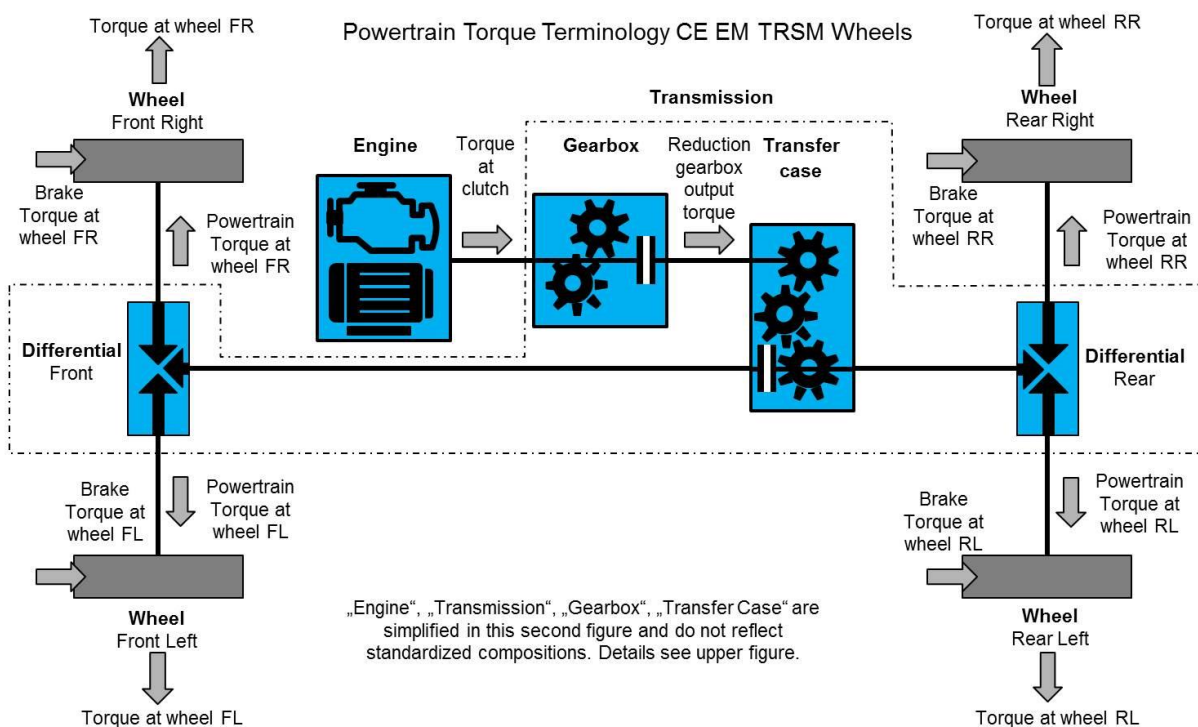
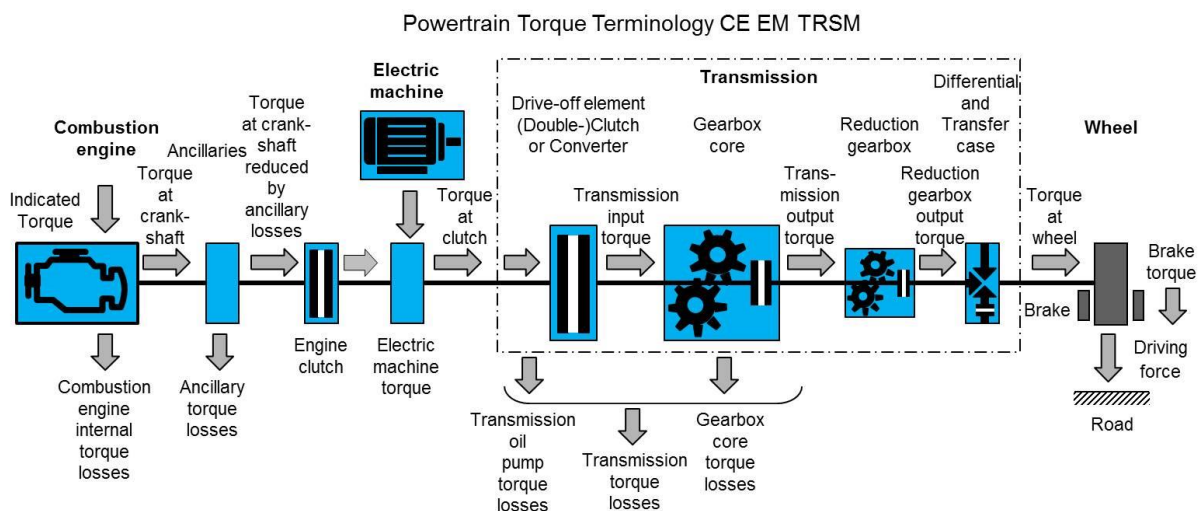

Sign definition for torque at clutch / torque at wheels:

Positive value means that torque is transmitted from the engine to the drivetrain / from the powertrain to the wheels.

Negative value means that torque is transmitted from the drivetrain to the engine / from the wheels to the powertrain.

Zero means that no torque is transmitted between engine and drivetrain / between wheels and powertrain.

Ancillary torque losses:

Ancillary torque losses are losses with influence on “torque at crankshaft reduced by ancillary losses” and “Torque at clutch” caused by e.g. alternator, airconditioning, power steering.

Consideration of the inertia in torque signals:

Torque influence of inertia is not considered, viz.

Torque effect caused by the inertia is not permitted to be considered additionally on engine side, viz.

- for an increasing engine speed, the indicated torque is not permitted to be increased by the torque which is necessary for the positive speed gradient, respectively
- for a decreasing engine speed, the indicated torque is not permitted to be decreased by the torque which is necessary for the negative speed gradient.

Engine Clutch:

For Hybrid Systems an additional clutch can be present between combustion engine and electric machine.

3.3 Terminology – Fast and Slow Torque Requests

Many torque request interfaces have the additional descriptors “Fast” or “Slow”. These descriptors are relevant to gasoline spark ignition engines, whose torque output can be modified by means of throttle angle (and hence air mass) and ignition timing. In general, the torque output responds slowly to changes in throttle angle due to fluid dynamics in the manifold and cylinder head. The reaction to ignition timing changes is almost instantaneous, especially at higher engine speeds.

“Fast” refers to the “immediate” / “instant” torque request, typically achieved by ignition timing.

“Slow” refers to the longer term or “torque reserve” request, usually the input to throttle control.

Note that a gasoline engine running at optimum ignition timing cannot **increase** torque quickly as the throttle is the only means for the increase. However, preemptively opening the throttle and running with retarded ignition to maintain the original (lower) torque allows the torque to be increased quickly by ignition a short time in the future. This operation is usually achieved by setting the “Slow” torque request to be greater than the “Fast” torque request to provide this “torque reserve”, allowing the torque to be rapidly increased by increasing the “Fast” request.

Torque Reserve concept with Fast and Slow torque requests

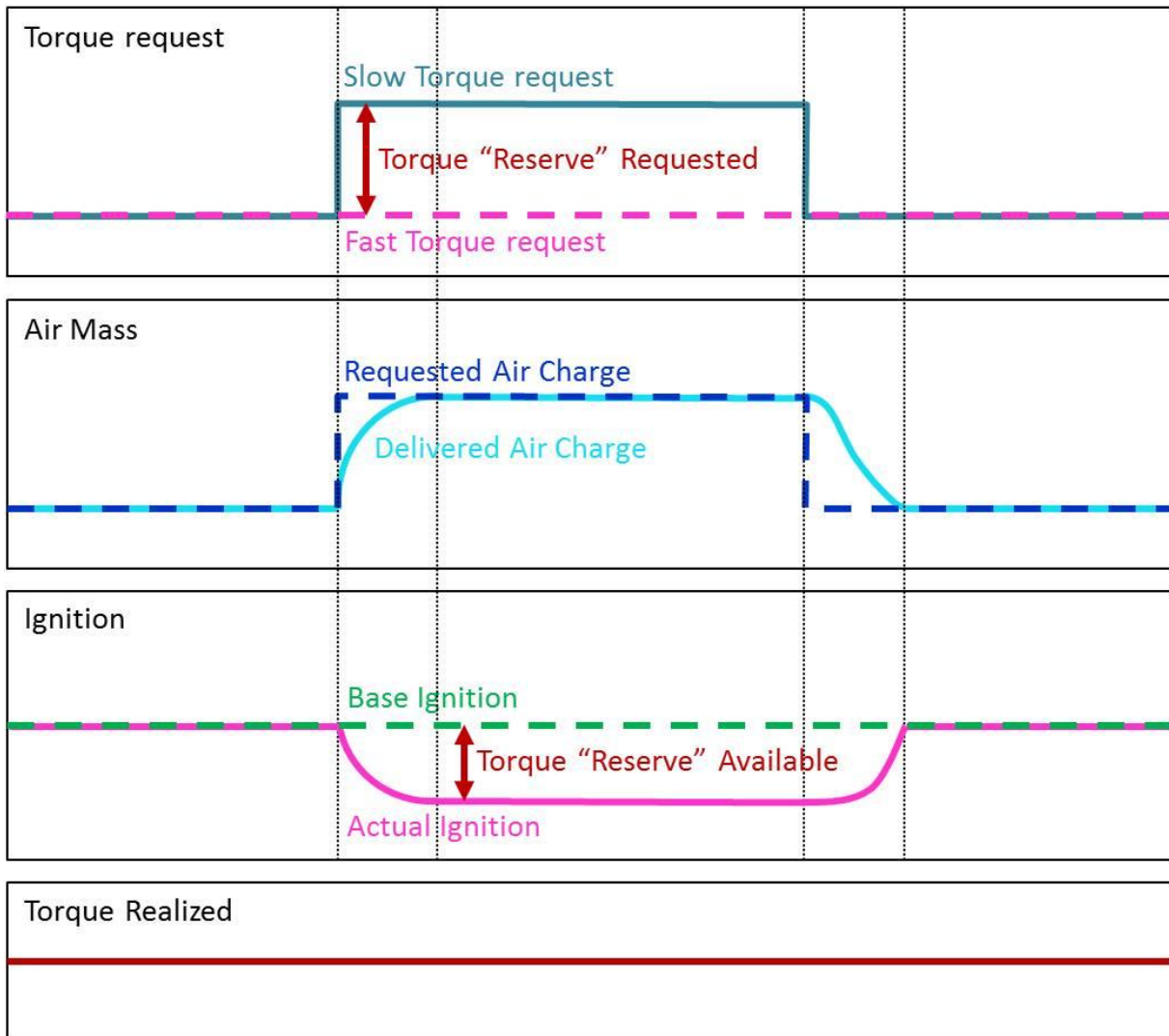

Torque Reserve concept with Fast and Slow torque requests

For conventional diesel engines only the fast torque interfaces are relevant. However, future diesel engines could have the possibility to use both fast and slow torque interfaces.

3.4 Typical combinations of signals for transmission shift intervention

Basically, there are two different possibilities to transmit a transmission torque at clutch request:

A) Torque request via one torque signal, which can transmit increasing and reducing torque requests *Transmission: Request for Torque at Clutch for Shift Intervention* in combination with a Request for implementation type, which defines if the request on the torque signal is an increasing or a reducing one, an absolute or a relative one *Transmission: Implementation Type of Request for Torque at Clutch for Shift Intervention*

or

B) Request via two torque signals and one signal for implementation type:

- One torque signal defines the “maximum torque”, which reflects the upper limit of the allowed torque. This is used to request a reducing torque intervention, *Transmission: Request for Maximum Torque at Clutch for Shift Intervention on Fast Path*,
- The other torque signal defines the “minimum torque”, which reflects the lower limit of the requested torque. This is used to request an increasing torque intervention, *Transmission: Request for Minimum Torque at Clutch for Shift Intervention on Fast Path*,
- The signal for implementation type defines, if the request is an absolute one (request to decrease/increase torque TONm) or a relative one (request to decrease/increase torque BYNm), *Transmission: Implementation Type of Request for Maximum and Minimum Torque at Clutch for Shift Intervention on Fast and Slow Path*.

Both possibilities may be accompanied project specific by extended or more detailed requirements as, for example,

- Intervention mode, which requests that the intervention has to be implemented by ignition angle and/or air and/or cylinder cut off.
- A torque reserve (which has no influence to “torque at clutch”) and its request for implementation type. These two signals prepare the possibility for an upcoming fast increasing torque intervention on gasoline engines.

Request for shift intervention concerning possibility A:

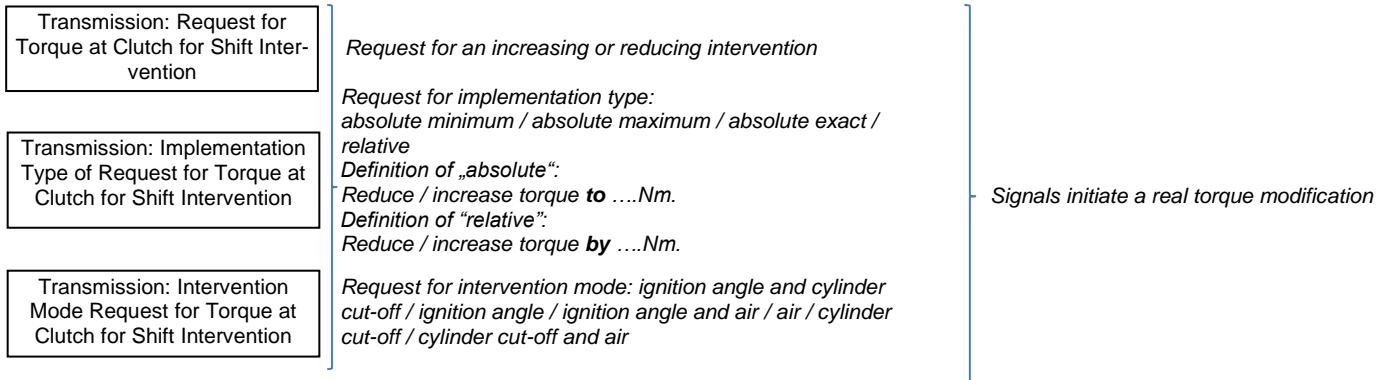

Request for shift intervention concerning possibility B:

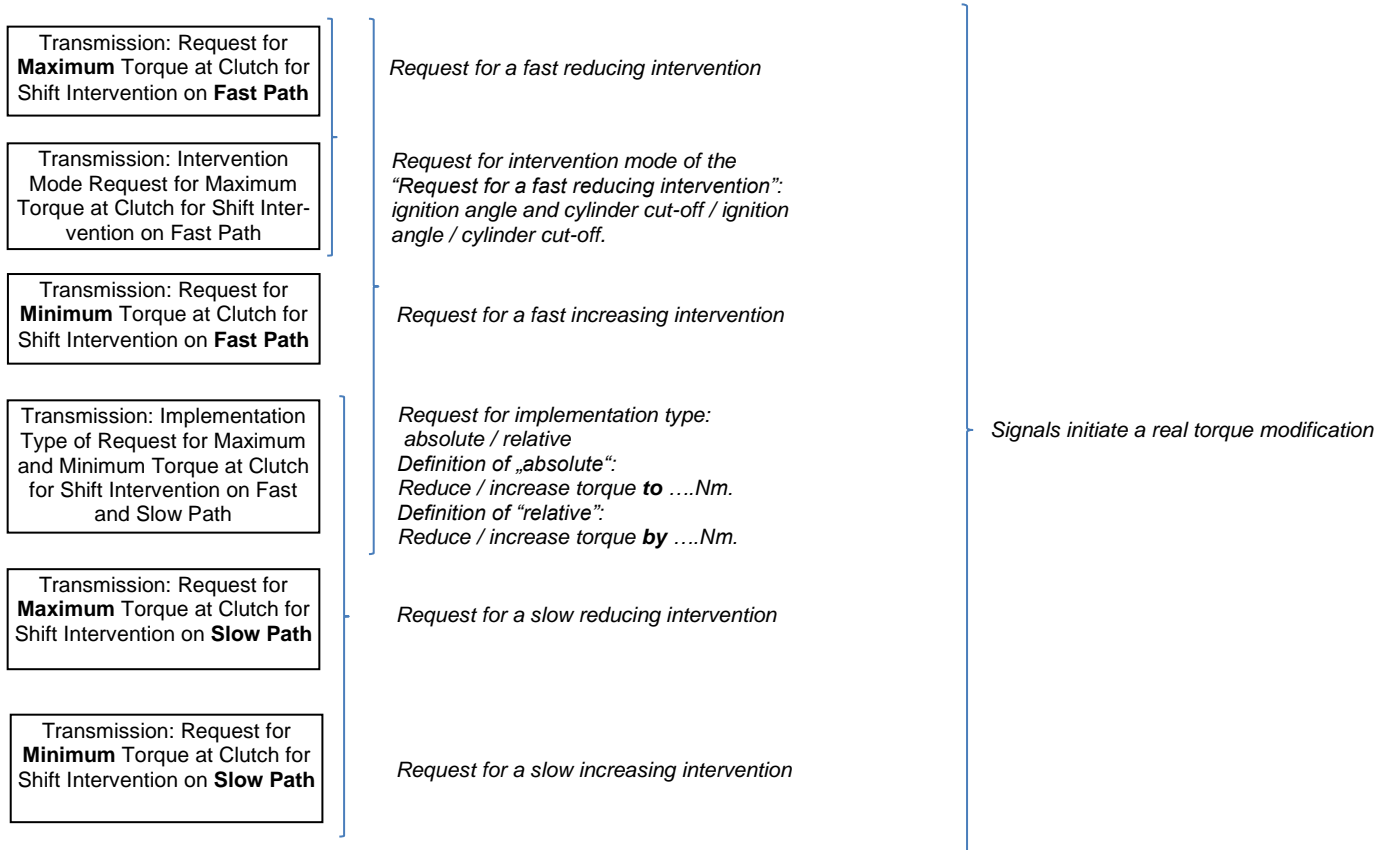

Request for a torque reserve as add on for possibilities A and B:

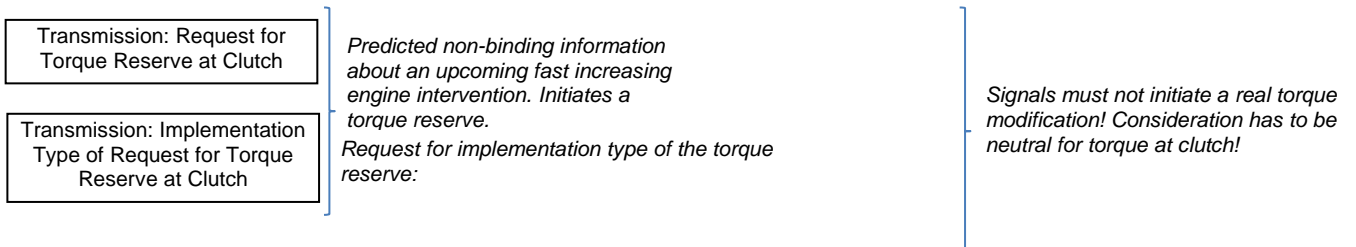

3.5 Overview of AUTOSAR torque application interfaces

Legend:

<shortName of Port>

<longName of Port>

Arrows represent the direction of the requirement (increase/ decrease of torque).

Horizontal lines represent the target level of the requirement.

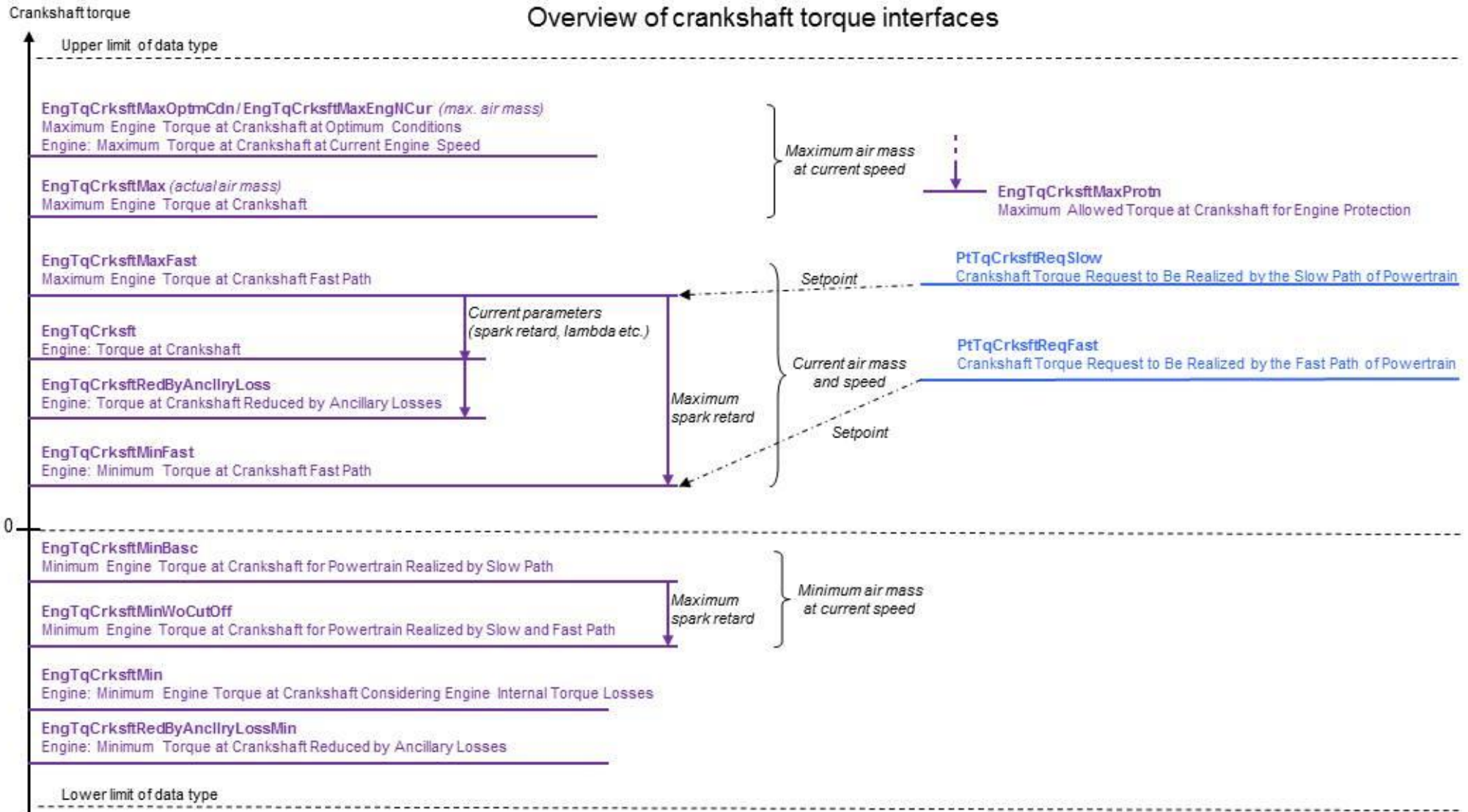

Overview of crankshaft torque interfaces

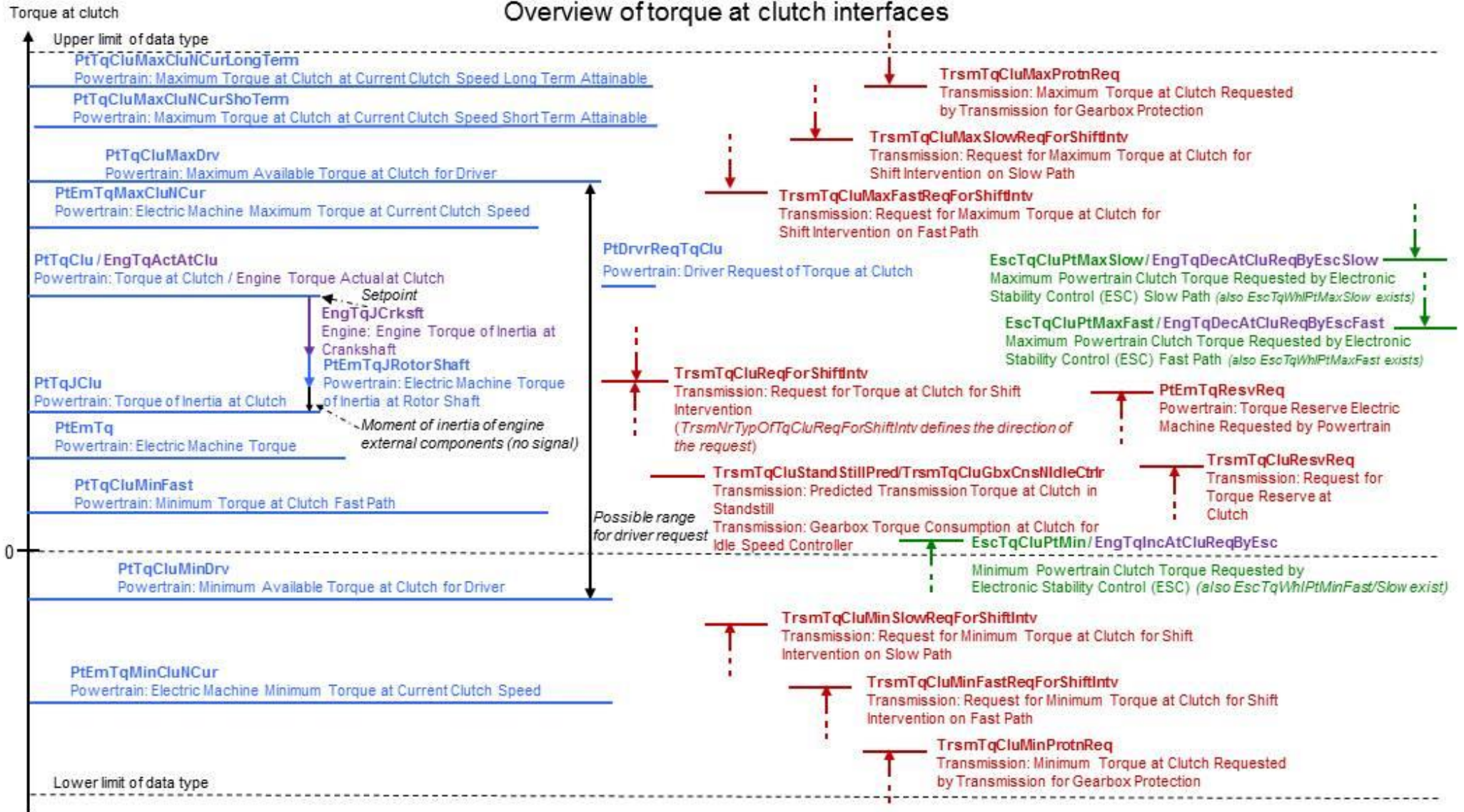

Overview of torque at clutch interfaces

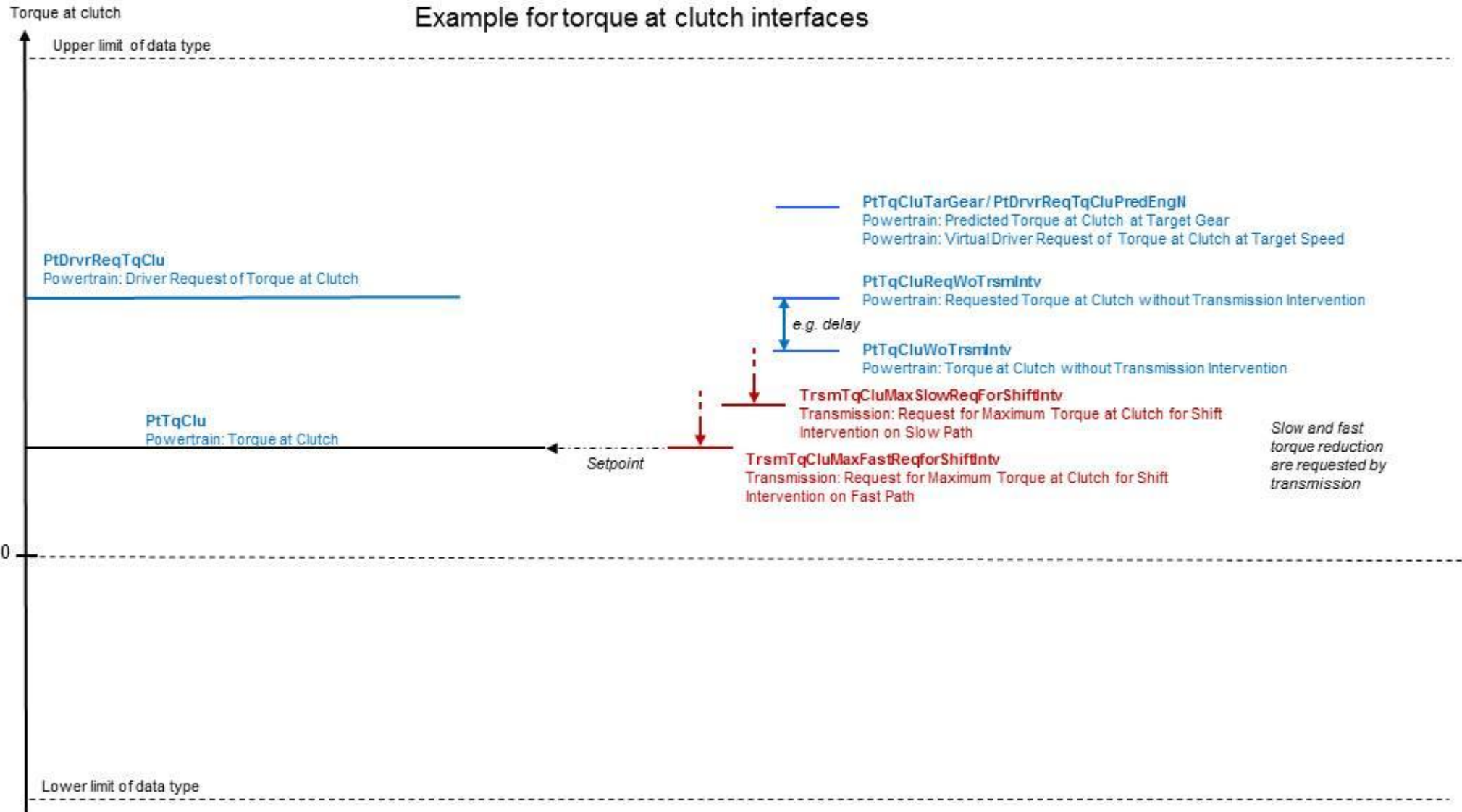

Example for torque at clutch interfaces

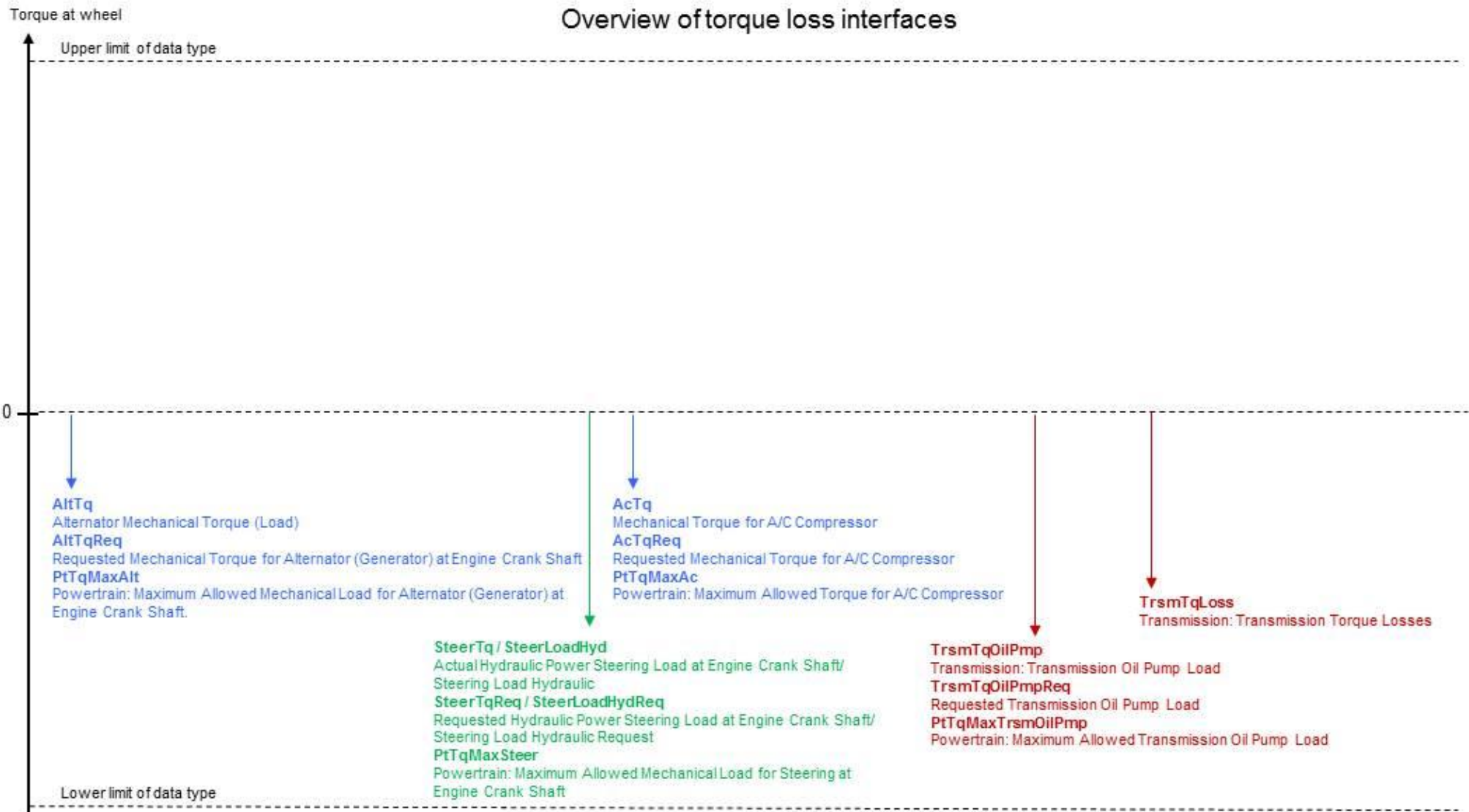

Overview of torque loss interfaces

Overview of torque at wheel interfaces

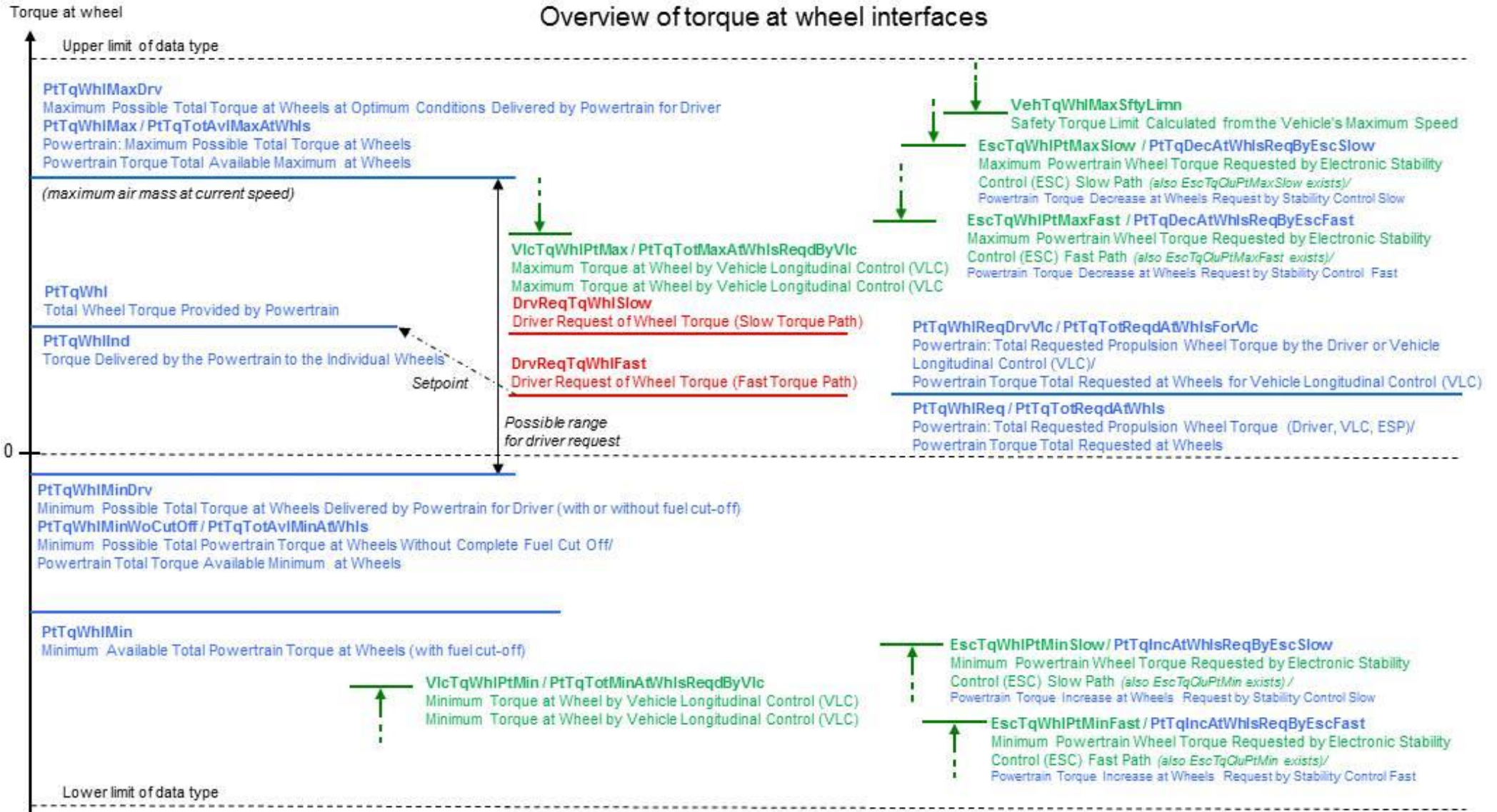

Overview of torque at wheel interfaces

4 Architecture Overview

The following figures give an overview of the domain or functional architecture. They not necessarily give a complete picture but show the most relevant interconnections and components.

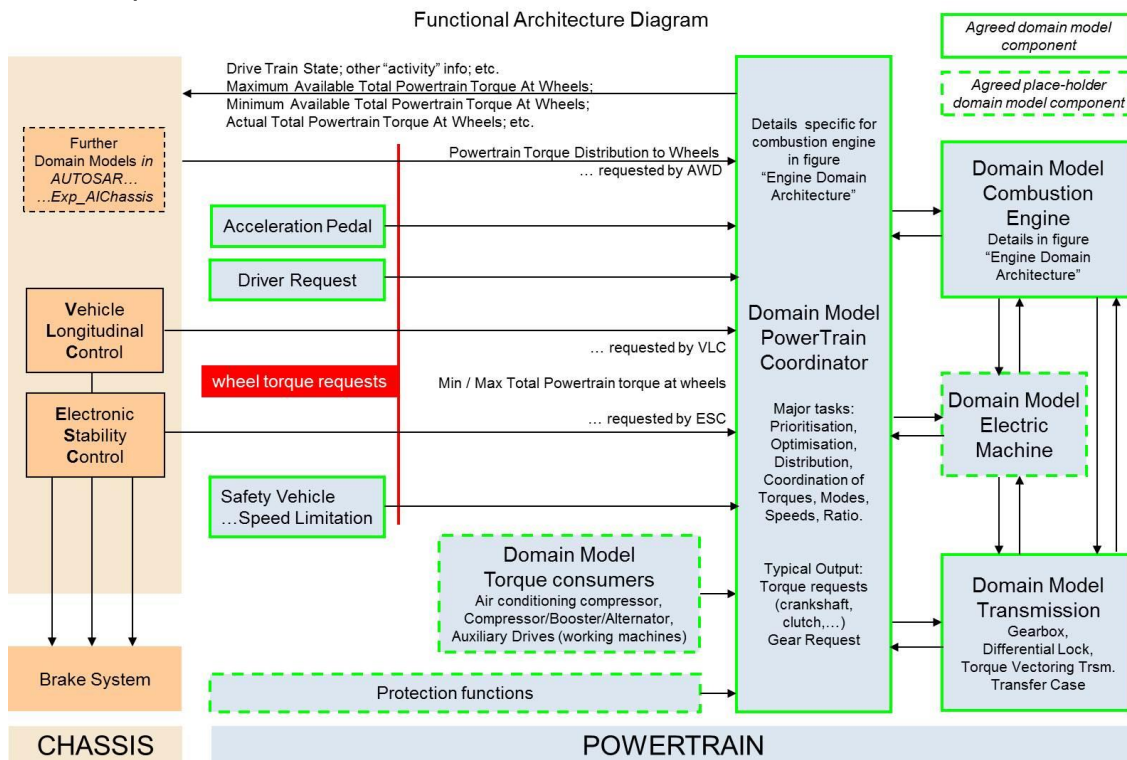

Functional Architecture Diagram

Engine Domain Architecture Diagram

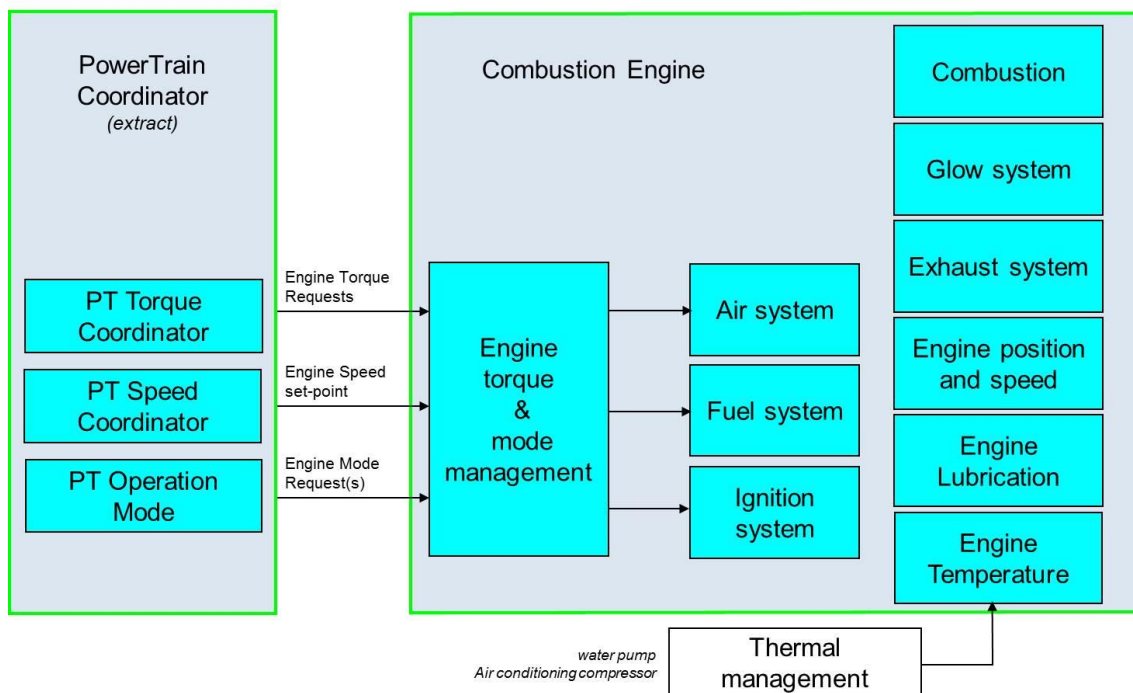

Engine Domain Architecture Diagram

5 Description of Exemplary Software Components

For being able to use and understand the standardized application interfaces a typical domain architecture was used as basis for demonstrating the signal flow. The components of this example domain architecture are described in the following.

5.1 Powertrain Coordinator – PTC (PtCoorr)

This composition includes all functions that coordinate the operation of the Powertrain, including:

Powertrain operation mode – management of states of all actuators (e.g. combustion engine, clutch(es), transmission, electric motors, etc.), including engine start / stop management (conventional & hybrid Powertrains).

Powertrain torque coordination – Torque coordination at Powertrain (PT) level, torque prioritisation, torque distribution for realization at at PT level, torque reserve request for the PTC, pre-coordination of driveability functions for hybrids, Powertrain driveability filters, determination of total Powertrain losses for torque calculation, wheel torque calculation (min, max, consolidated), torque at clutch calculation (min, max, consolidated), transformation of torque set point from wheel torque to torque at clutch, transformation of torque set point from torque at clutch to torque at crankshaft, control/coordination of auxiliary drivers/actuators.

Powertrain speed coordination – Maximum speed limitation coordination (for protection of all PT components from damage from over speed) and coordination of idle speed / engine speed set point requests from all sources, e.g. transmission.

Powertrain ratio coordination – all transmission ratio set point logic. Note that realization of ratio set point is carried out by transmission system, not PTC.

5.2 Transmission System (Trsm)

This composition includes all functions of the transmission system, including:

Transmission system coordination – Determines the torque and speed ratio over transmission, converter and differential, including the calculation of torque losses in the transmission system. Coordinates mechanical protection of the Drivetrain (gearbox, driveshafts, etc.), including calculation of torque limitation.

For manual transmission, this function includes the determination of the current gear and clutch status.

Transmission – Management of particular states in the transmission, including shift transition, driving off situation, creeping mode etc.. In case of shift transition, this functionality calculates torque requests to optimise the transition.

Control of transmission actuators to adjust the gear to the target gear (or to adjust the gear ratio to the target gear ratio in case of CVT). Gear ratio means the theoretical / physical ratio belonging to each gear and not any actual measured value. Control of gearbox countershaft (low/higher range) actuators is not included.

Calculates the torque gain of a hydrodynamic converter and the torque required to the converter input side in idle, etc. and controls clutch or converter actuators.

All functionality related to the protection of the transmission, including calculation of torque limitation, measurement or calculation of gearbox oil temperature, etc., and calculation of requests to other systems.

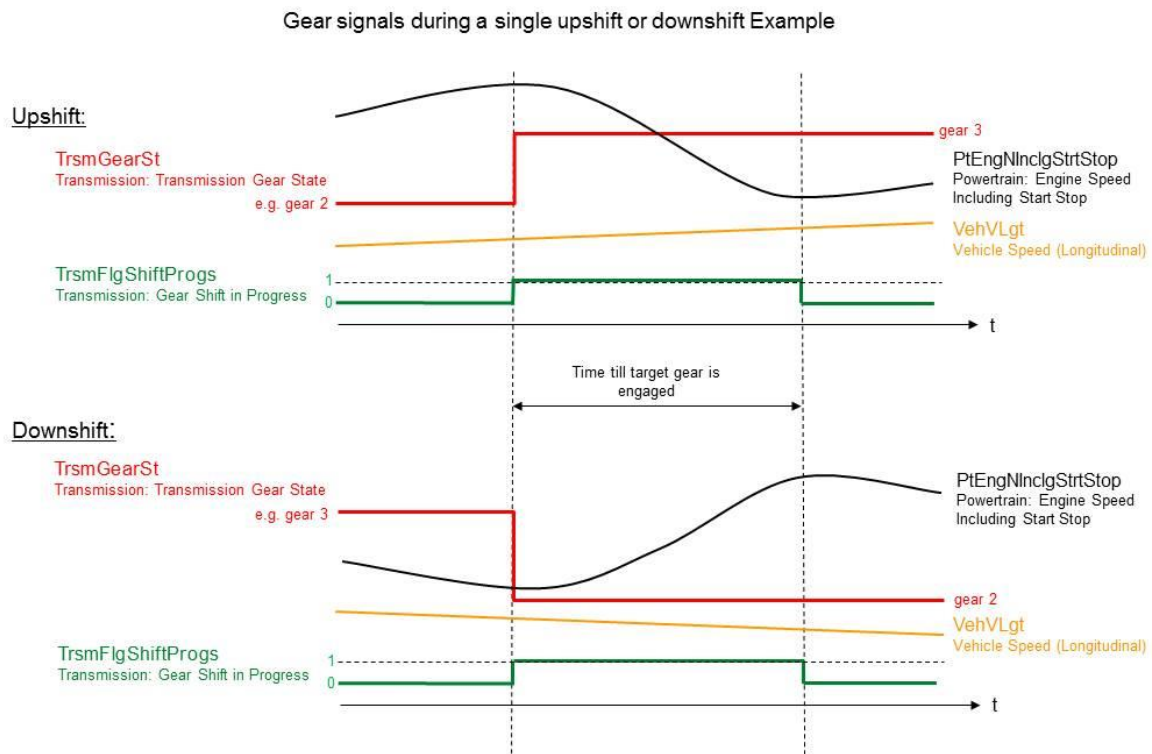

Gear signals during a single upshift or downshift Example

Drivetrain Torque Distribution (DtTqDibtn) Differential Lock – All functionality related to the differential(s), which manage the torque distribution between left and right wheels, for example locking of the differential. Does not include the calculation of the distribution set point.

Drivetrain Torque Distribution (DtTqDibtn) Transfer Case – All functionality related to the transfer case, which manages the torque distribution between front and rear wheels. Does not include the calculation of the distribution set point.

Drivetrain Torque Distribution (DtTqDibtn) Torque vectoring axle transmission – All functionality related to active distribution of powertrain torque to all four wheels individually. Does not include the calculation of the distribution set point.

For additional information on Drivetrain Torque Distribution (DtTqDibtn) please also refer to [4].

5.3 Combustion Engine (CmbEng)

This composition includes all functions directly related to the operation and control of the vehicle's combustion engine. The following sections, 5.3.1 to 5.3.3 inclusive, define the components as a result of Combustion Engine functionality decomposition agreed to date.

5.3.1 Engine Speed and Position (EngSpdAndPosn)

Functions that provide all parameters linked to engine shaft position and speed, including the synchronisation on between crankshaft and camshaft.

Crankshaft and camshaft signal acquisition.
Calculation of the engine position.
Calculation of the relative camshaft position for systems with variable valve timing and/or lift.
Related diagnosis and plausibility checks.

5.3.2 Engine Torque Mode Management (EngTqModMngt)

Includes calculation of engine torque set point, realization of that set point (coordination of air / fuel / ignition, etc.), determination of consolidated engine torque, control of engine speed (idle / off-idle / limitation), and management of engine modes (including overall mode, modes for realization of engine start & stop, and combustion modes).

5.3.3 Combustion Engine: Miscellaneous (CmbEngMisc)

Combustion Engine Misc gathers together miscellaneous engine interfaces. In general, these are common data required for correct operation of the engine (engine temperature, ambient air pressure and battery voltage) or required for fail-safe actions (crash status). The way in which these interfaces are used is not standardized. In future AUTOSAR releases, it is likely that these interfaces may be moved to different (more appropriate) provider or receiver components / compositions.

5.3.4 Combustion Engine: Timing- and Accuracy requirements on the signal “Powertrain: Engine Speed Including Start Stop”, necessary for transmission.

Timing- and Accuracy requirements to signal
“Powertrain: Engine Speed Including Start Stop”, PtEngNInclgStrtStop
(these requirements apply accordingly to signal “Powertrain: Clutch Speed”, PtCluN)

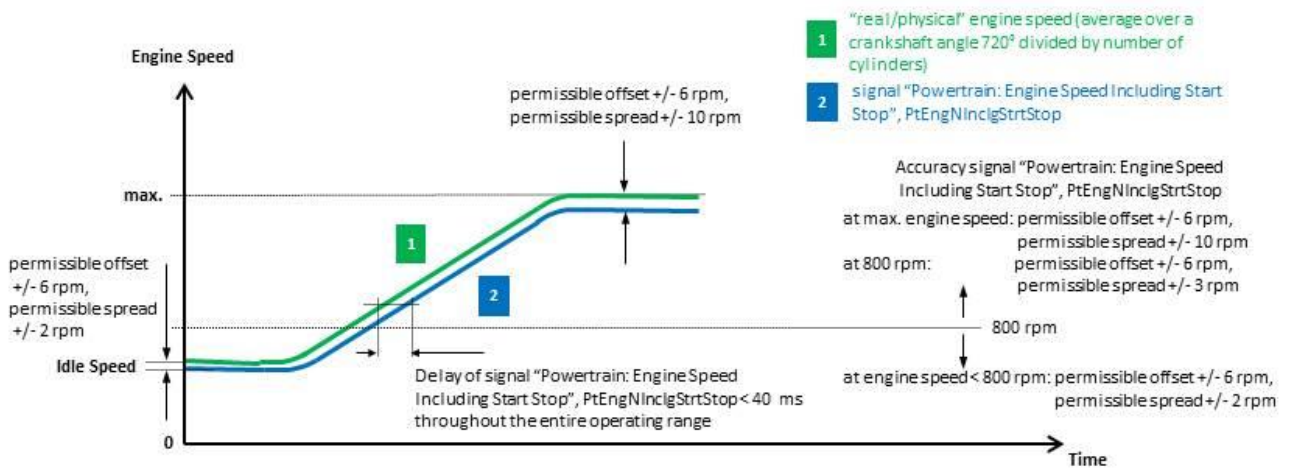

All the accuracy and response time requirements mentioned in this graphics are „goals“. Project specific requirements have to be defined in close cooperation of transmission and engine engineering.

Engine Speed Including Start Stop Accuracy Requirements

Additional requirements for timing and accuracy on the signal “Powertrain: Engine Speed Including Start Stop” during engine start and shut down:

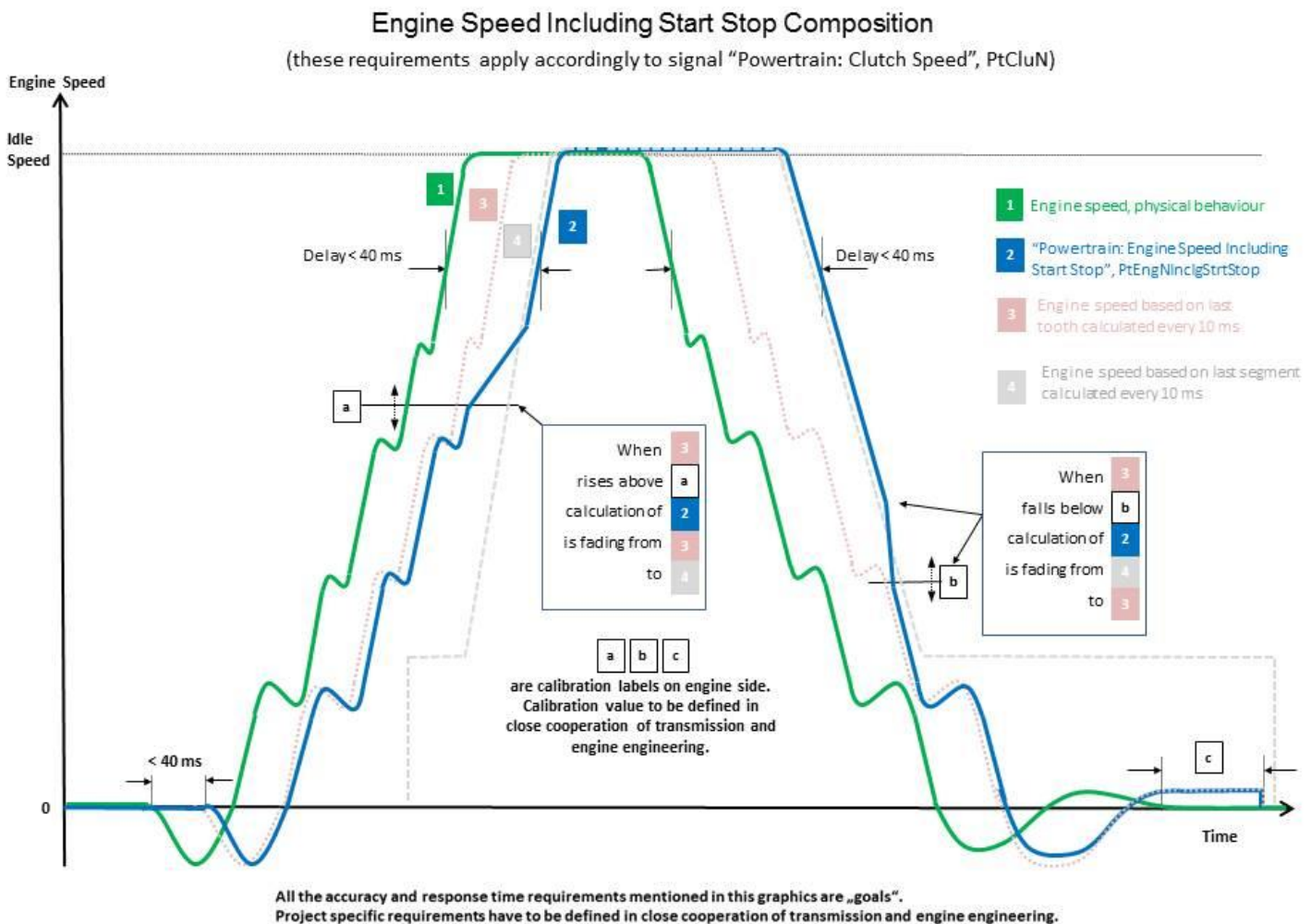

Engine Speed Including Start Stop Composition

Legend:

Calculation of “Powertrain: Engine Speed Including Start Stop” on the engine side:

Combination of

“Engine speed based on last segment calculated every 10 ms”

and

“Engine speed based on last tooth calculated every 10 ms”.

For a high engine speed, greater than the upper hysteresis limit “a”, signal

“Powertrain: Engine Speed Including Start Stop” is “Engine speed based on last segment calculated every 10 ms”.

For a low engine speed, less than the lower hysteresis limit “b”, the signal

“Powertrain: Engine Speed Including Start Stop” is “Engine speed based on last tooth calculated every 10 ms”.

The transition between a high engine speed and a low engine speed is defined by a hysteresis with an upper threshold “a” and a lower threshold “b”.

If the engine speed increases to a value greater than above “a”, then the number of teeth used for the speed calculation is incremented up to segment length using a defined step width.

The incrementation is done depending on the time after crossing “a”.

If the engine speed decreases to a value less than “b”, then the number of teeth used for the speed calculation is decremented down to one using a defined step width.

The incrementation is done depending on the time after crossing “b”.

The input for the hysteresis is “Engine speed based on last tooth calculated every 10 ms”.

At a negative engine speed “Powertrain: Engine Speed Including Start Stop” is calculated based on one tooth.

Additional requirements on “Powertrain: Engine Speed Including Start Stop” in the range of 0 rpm up to an idle speed are necessary to ensure comfortable engine starts:

Requirements on engine start:

The first speed information must be available at the latest after 40 ms after the first crankshaft motion. This is necessary to be able to detect when the engine starts to rotate.

Requirements on engine stop:

- When switching off the engine,
 - “Powertrain: Engine Speed Including Start Stop” must deliver physically correct values down to 0 rpm.
 - there is a permissible max. delay time “c” between engine standstill and when the signal “Powertrain: Engine Speed Including Start Stop” is equal to 0 rpm.
- The engine is not permitted to switch off bus communication before “Powertrain: Engine Speed Including Start Stop” = 0 rpm.

5.4 Vehicle Motion relevant for Powertrain (VehMtnForPt)

This composition includes Powertrain functions related to vehicle motion. The following sections, 5.4.1 to 5.4.3 inclusive, define the components that have so far been agreed as part of this composition.

5.4.1 Driver Request (DrvReq)

Driver-specific conversion of accelerator pedal position to requested torque: determines the driver request related to the motion of the vehicle. For longitudinal motion, this functionality interprets the driver request as a torque request.

5.4.2 Accelerator Pedal Position (AccrPedIPosn)

The component calculates a percentage from the acquired position of the sensor and contains plausibility checks to ensure the information. Kick-down detection is included in this component.

5.4.3 Safety Vehicle Speed Limitation (VehSpdLimnForSfty)

Hard limitation of vehicle speed by engine torque reduction, without any comfort functionality.

5.4.4 Vehicle Motion (Powertrain): Miscellaneous (VehMtnForPtMisc)

VehMtnForPtMisc gathers together miscellaneous interfaces in the context of vehicle motion powertrain. The way in which these interfaces are used is not standardised. In future AUTOSAR releases, it is likely that these interfaces may be moved to different (more appropriate) provider or receiver components / compositions. It is even not excluded that they are moved to components that already exist.

VehMtnForPtMisc e.g. is used to close open interfaces in the case that it is committed that some component within vehicle motion powertrain will request or provide it but it is not yet decided which component or the component is missing.

5.5 Powertrain: Miscellaneous (PtMisc)

PtMisc gathers together miscellaneous powertrain interfaces. The way in which these interfaces are used is not standardised. In future AUTOSAR releases, it is likely that these interfaces may be moved to different (more appropriate) provider or receiver components / compositions. It is even not excluded that they are moved to components that already exist.

PtMisc e.g. is used to close open interfaces in the case that it is committed that some component within powertrain will request or provide it but it is not yet decided which component or the component is missing.

6 Additional Information

6.1 Differences between SW-Cs and ECUs

The SW components defined in chapter 4 are not to be confused with an ECU's functionalities.

For example, a combustion engine control ECU may contain the Combustion Engine SW-C plus other SW-Cs.

6.2 Functional safety

Many Powertrain signals are safety-relevant, therefore

The AUTOSAR RTE will provide reliable communication for these signals at the low level, and

Diagnostics and safety concepts for these signals must be applied at the higher, functional level.

AUTOSAR does not provide a Safety Concept for Powertrain systems. This must be done at the project level. This means that the specified interfaces must be checked to fulfill the safety requirements on each specific project.

6.3 Powertrain Application Interfaces - Decisions / Assumptions

6.3.1 Scope

In this document only passenger cars are considered.

6.3.2 PTC Composition (PtCoorr)

The PTC is not an atomic AUTOSAR SW-Component. In fact, its functionalities should be separated, into several sub-components. These sub-components will communicate with each other and with AUTOSAR SW-Components outside the PTC. The interfaces between the sub-components are not in the current scope, which is restricted to the definition of main interfaces between the non-PTC components and the PTC sub-components.

6.3.3 Definition of overboost

Overboost is a state in which the maximum torque which the combustion engine can deliver is increased for a limited period of time. Depending on the engine type, this could be realised, for example, as an increase in boost pressure on a turbocharged engine.

6.3.4 Coordination at the vehicle level

Coordination of vehicle energy (mechanical / electrical / thermal), vehicle operation modes, vehicle personalisation, etc., should be done at the vehicle level. This is not in the scope of the Powertrain Application Interfaces.

The composition VehMtnForPtMisc was added as an interim solution for some vehicle level issues relevant to the powertrain domain.

6.3.5 PTC Arbitration between Driver and Chassis torque requests

The two figures below show how the VLC and Stability Control torques requests could be arbitrated with the Driver Request. This is just an example to illustrate the concept behind the powertrain torque request interfaces, it is not intended to standardise the arbitration behavior in the PTC.

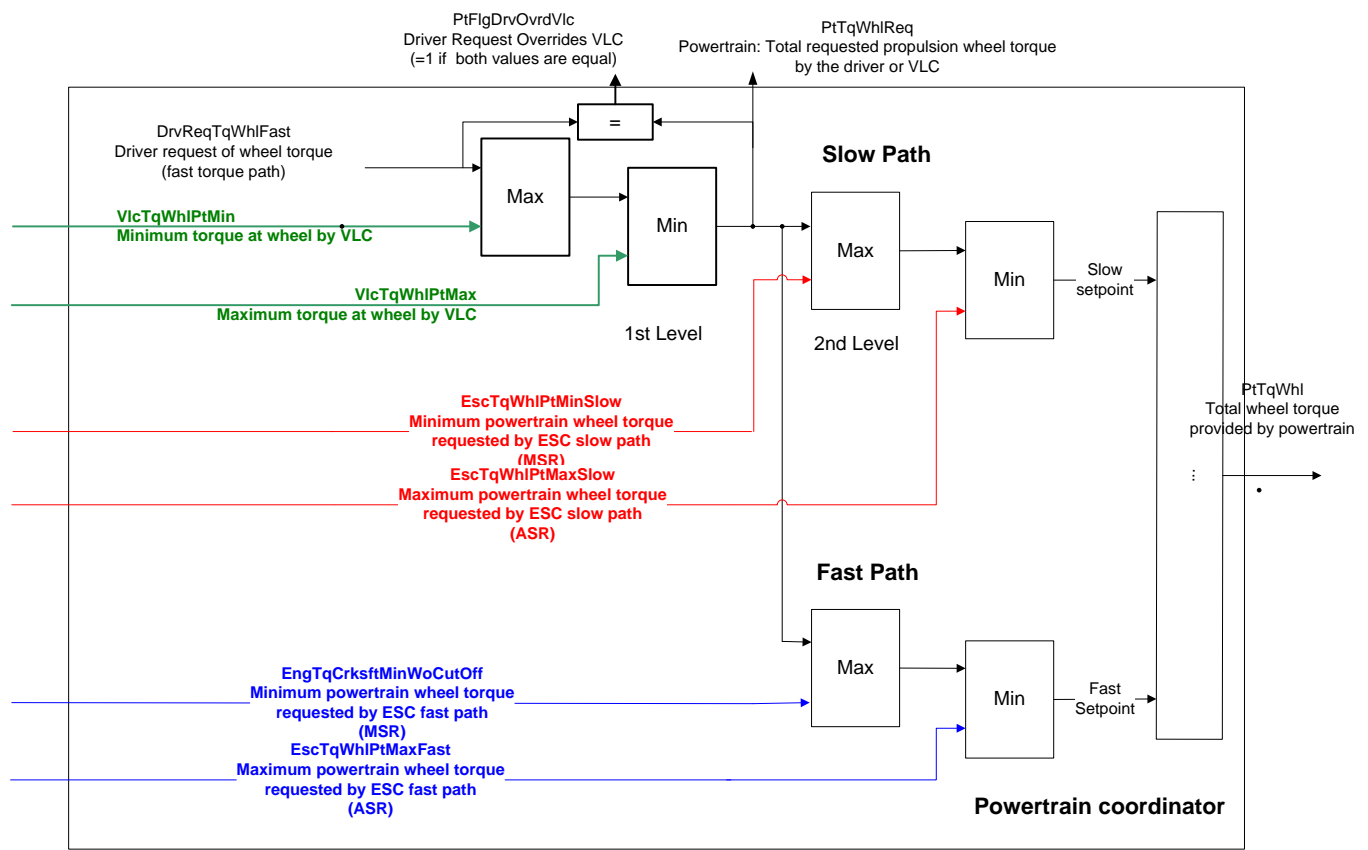

v2.02

VLC and ESP Arbitration in PTC

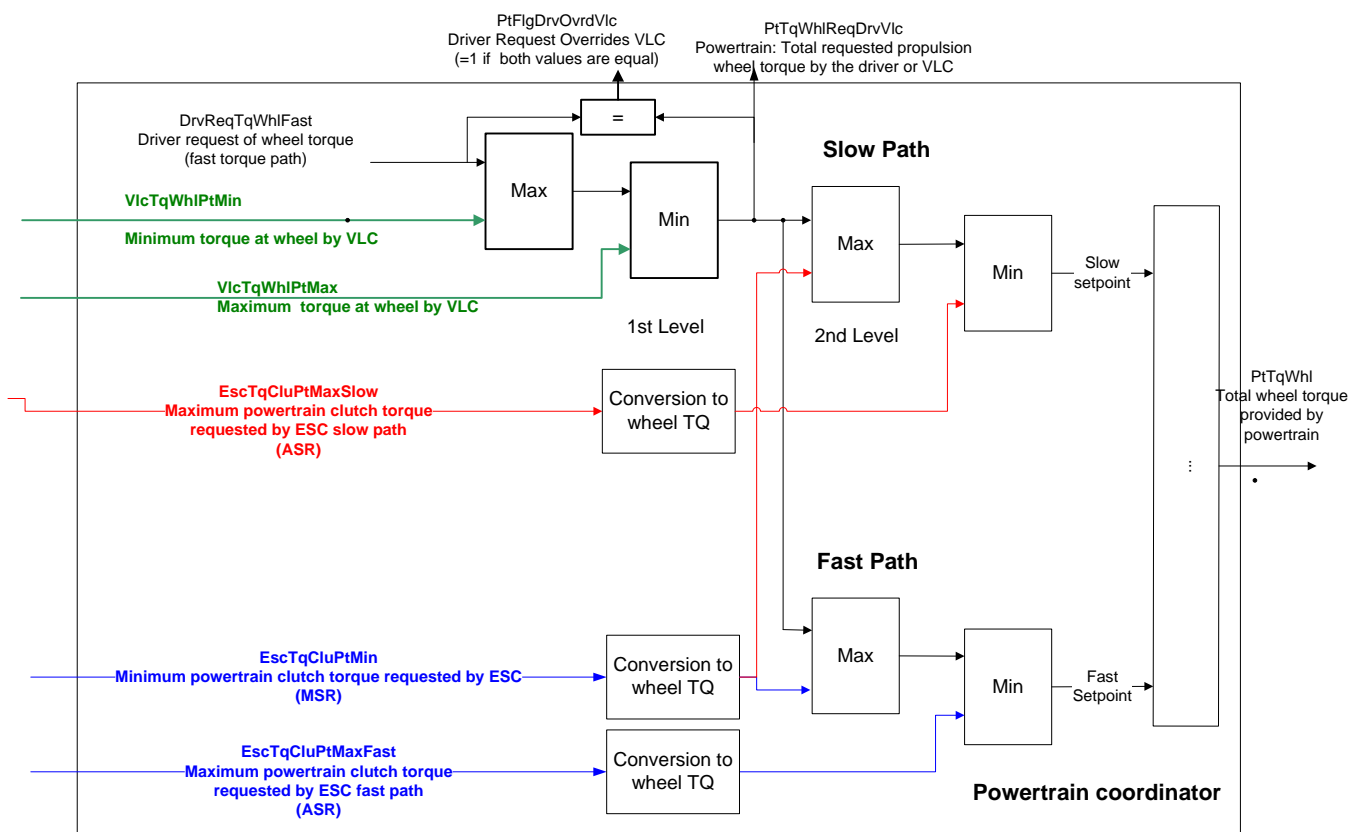

v2.02

VLC and ESP Arbitration in PTC based on TQ at clutch

6.3.6 Assumptions on modeling style and naming aspects specific for powertrain domain

AUTOSAR provides a guideline for modeling and naming of model elements ([1]).

There are architectural design patterns like the sensor actuator design pattern described in [11] that also include modeling and naming aspects.

In this section only additional patterns and modeling styles followed are explained to get an overall understanding of the signals standardized for the powertrain domain.

Please note: Here standardized ports or port interfaces mean standardized port prototype blueprints or port interface blueprints [7].

| | |
|--|---|
| Kind of Modeling in general applied within powertrain domain, especially if the system modeling guideline [1] gives some freedom. | |
| Kind of modeling or assumptions | Rationale |
| All <i>SenderReceiverInterfaces</i> standardized are assumed to be measurable. | In earlier versions the standard did not contain information about calibration and measurement. Since R4.0.3 all data types allow measurement by default (see generated .arxml [3]). So our implicit |

| Kind of Modeling in general applied within powertrain domain, especially if the system modeling guideline [1] gives some freedom. | |
|--|---|
| Kind of modeling or assumptions | Rationale |
| | assumption that all signals are measurable is fulfilled. |
| All ports are assumed to be optional. | <p>Within our example components all ports are assumed to be optional. The ports are derived from the port prototype blueprints with the same name. It is optional per default that port prototype blueprints are allowed to be used but not necessarily used in every project.</p> <p>In previous releases without blueprints this assumption was very important because there was no variant handling done. So within the powertrain domain it was assumed that all ports are optional. Since only ports but no components are standardized this was even more important: it means that a supplier or OEM may create a single SW-C (Software Component) and use only the standardized ports that are relevant for this SW-C in his sw architecture.</p> |
| <p>Port interfaces are not designed to be reused: there is a 1:1 relationship between port and port interface. The port interface has the same name as the port + an additional index as required by the System Modeling Guideline [1].</p> <p>Exception: If powertrain is not the provider then the rules of other domains are respected.</p> | <p>Ports are attached to SW-C. Since SW-C are not standardized only port interfaces were really subject of usage in projects up to Release 3.1.</p> <p>With Release 4.0 the standardization of ports is supported by using so-called <i>PortPrototypeBlueprints</i> in the meta model.</p> <p>However, in practice older versions of the AUTOSAR meta model are still in use and the existing tools do not yet fully support <i>PortPrototypeBlueprints</i>.</p> <p>To be backward compatible and to enable the easy introduction of the standardized application interfaces within the powertrain domain not all features of the meta model (like e.g. connection of compatible interfaces with different port interface short names) therefore were yet fully exploited.</p> <p>Connecting of compatible interfaces with different port interface short names is not supported.</p> |
| If a port interface contains exactly one data prototype its name is identical to the port interface excluding the trailing index. | <p>There were only two alternatives:</p> <ul style="list-style-type: none"> - using full name - using name "Val" for Value <p>Disadvantage of solution 2) would have been that many ports would have been assumed to be compatible by tools because identical data prototype names (with compatible interfaces) allow an automatic connection.</p> <p>Within specification tools like e.g. ASCET-SD or</p> |

| Kind of Modeling in general applied within powertrain domain, especially if the system modeling guideline [1] gives some freedom. | |
|---|--|
| Kind of modeling or assumptions | Rationale |
| | MATLAB/Simulink it might be possible to only show the data prototype name and to not display the port interface or port name. |
| The reuse of data types was explicit goal within the powertrain domain. | Within the powertrain domain it was an important design goal to use as few data types as possible. |
| Computation methods were not subject to reuse yet. | The reuse of computation methods is not supported, but only re-use of data types. But reuse of computation methods should be considered for the next release. |
| In most cases only one data prototype was defined per port interface. | <p>This kind of modeling allows the biggest flexibility in implementing the standard.</p> <p>On assembly level e.g. it is not allowed that the r-port has more data prototypes than the p-ports ([6], figure 6.3). Therefore in such cases, when several data prototypes are part of one r-port the data prototypes themselves cannot be assumed to be optional, only the complete r-port.</p> <p>In older versions of the AUTOSAR standard it was not allowed that a sub-component provides only part of the port, i.e. if several data prototypes were part of a port interface it was implicitly standardized that there is one SW-C providing it. When splitting the information on several port interfaces each data prototype might be provided by a different SW-C.</p> |
| In most cases no records were used to define port interfaces. | <p>The rationale is similar to the one stated for the assumption to only define one <i>DataPrototype</i> per <i>PortInterface</i>.</p> <p>Since within the powertrain domain <i>PortInterfaces</i> with multiple <i>DataPrototypes</i> are seldomly used, there is no necessity to use records and it is assumed that timing related aspects of the data prototypes are to be handled separately, that there are other more flexible possibilities to do so.</p> |

| Specific Naming Assumptions for Powertrain Domain | |
|--|--|
| Assumption | Rationale |
| The names were chosen such that automatic generation of display names is possible. | In Powertrain ECUs there are thousands of calibration relevant data. So it is important to apply the System Modeling Guideline [1] in a way that automatic generation of display names is possible. See [5] for details. |
| In general the keyword abbreviation "Consold" for "Consoli- | Reason for doing so is to have short names whenever possible (see [TR_MCM_70020] in [5]) |

| Specific Naming Assumptions for Powertrain Domain | |
|--|--|
| Assumption | Rationale |
| dated” as well as the abbreviation “Act” for “Actual” was suppressed. | Example: <i>PtTqClu</i> for “Torque at Clutch “ |
| In case a port is only for Fast Path or Slow Path “Fast” and “Slow” is added. In the other cases “SlowFast” is suppressed. | Reason for doing so is to have short names whenever possible (see [TR_MCM_70020] in [5]) Example: <i>PtTqWhlMinWoCutOff</i> affects Slow and Fast path <i>EscTqWhlPtMaxSlow</i> or <i>EscTqWhlPtMaxFast</i> is for a specific path For more details on fast and slow paths see chapter 3.3 |
| “State” is used as abbreviation “St” for “State” and “Status”. | In most cases it is very difficult to explain the difference between State and Status. So for sake of simplicity and consistency within the powertrain domain only “St” is used. |
| TqWhl means sum of Torque Wheels whereas TqWhlInd means the torque of an individual wheel. | Within Powertrain the sum of torque wheels is more often used. So information (“Ind”) is added in the case that individual wheel torques are meant. Example: <i>PtTqWhl</i> for “Total Wheel Torque Provided by Powertrain” <i>PtTqWhlInd</i> for “Torque Delivered by the Powertrain to the Individual Wheels” |
| Prepositions are only used in the short name if it really helps understanding. | In most cases the preposition does not really add information and makes short names unnecessarily long (see [TR_MCM_70020] in [5]). Examples: <i>PtTqWhlMinWoCutOff</i> for Minimum Possible Total Powertrain Torque at Wheels Without Complete Fuel Cut Off using the preposition ‘Wo’ (without) <i>PtTqWhlReqDrvVlc</i> for Powertrain: Total Requested Propulsion Wheel Torque by the Driver or Vehicle Longitudinal Control (VLC) instead of <i>PtTqAtWhlReqByDrvForVlc</i> as recommended by the system modeling guideline [1]. |
| Special rules for engine-transmission interfaces | - Each Long Name starts with the provider and colon “:”. Only if the provider cannot be defined, the provider and the colon are omitted. - If the reference object and the reference level for the speed are not explicitly stated, then the reference object and the reference level for the speed |

| Specific Naming Assumptions for Powertrain Domain | |
|--|---|
| Assumption | Rationale |
| | are the object itself. Example: a) "Engine: Torque at Crankshaft" is the torque at the current crankshaft speed, not at idle speed, max. speed, b) "Engine: Torque at Crankshaft" is the torque at the crankshaft level, not at wheel level. |